



**Quality You Can Trust**  
**Service You Can Depend On**



# AmPro®

## Professional Tools

"AmPro" is the acronym we have defined as "I Am Professional" to embody the adept skill, cultivated mind and creative spirit that are instilled throughout the creation of an AmPro product. As the leading supplier of top quality hand tools, air tools, electrical and cordless power tools, automotive specialty tools, garden tools and power equipment, we are devoted to meeting the needs of our customers and helping them achieve their goals.

Excellence in one's work and craftsmanship is the hallmark of the professional and the heart of AmPro. When you use an AmPro product, you will share in the distinguished heritage of expertise and pride that went into the making.

In our industry, technology is always changing. Significant advances in our design, construction, performance, reliability and presentation are the culmination of over twenty-six years of intensive market research, product development and quality assurance and control. We are committed to introducing innovative quality products at the forefront of new developments each and every year.

Our dedication to excellence is not limited to craftsmanship alone. Diligent focus on market research, individual customer requirements and extensive customer feedback protocols





have enabled us to provide our customers today with custom-tailored, full-service programs featuring strategic product selection and prompt delivery.

The diversity of products debuted in this catalog demonstrates our commitment by offering nothing but the most complete programs to serve a wide variety of customer tastes, and to guarantee the right tool for the right job. Whether you're searching for a particular product or simply browsing, we're confident you'll find what you're looking for and more.





## Hand Tools

### Wagons & Chests Tools Sets (FA Series)

Wagon Tool Sets .....	10 - 14
Tool Wagons & Chests .....	15 - 16
Workstations .....	17
Wagon Accessories .....	18 - 19
Wagon Tool Tray Sets .....	20 - 22

### Wagons & Chests Tools Sets (WA Series)

Metal Chest Tool Sets .....	24 - 27
Wagon Tool Sets .....	28 - 36
Wagon Tool Tray Sets .....	38 - 44
Chest Tool Tray Sets .....	45 - 47
Metal Cases & Tool Chests .....	48 - 49
Tool Wagons .....	50 - 51
Tool Trolleys .....	52
Workstations .....	53
Tool Cabinets .....	54 - 55
Wagon Accessories .....	55 - 56

### Aluminum Case / Trolley Tool Sets

Aluminum Trolley Tool Sets .....	58 - 59
Aluminum Case Tool Sets .....	60 - 61
Tote Bags .....	62

### Fits-All Go-Thru Socket Sets .....

64 - 68

### Fits-All Socket Sets .....

70 - 72

### Ratchets & Accessories .....

74 - 90

### Sockets

1/4", 3/8" Dr. Sockets .....	92
3/8", 1/2" Dr. Sockets .....	93
1/2" Dr. Sockets .....	94
3/4" Dr. Sockets .....	95
1" Dr. Sockets .....	96
External Star Sockets .....	97
Industrial Bit Sockets .....	98 - 99
Bit Sockets Sets .....	100
Socket Sets - Rail .....	101
Socket Sets - Rack .....	102 - 103
Socket Sets - Metal Case .....	104 - 107
Socket Sets - Blowcase .....	108 - 118

### Impact Sockets

1/4", 3/8" Dr. Impact Sockets .....	120
1/2", 3/4" Dr. Impact Sockets .....	121
3/4" Dr. Impact Sockets .....	122
1" Dr. Impact Sockets .....	123
1", 1-1/2" Dr. Impact Sockets .....	124
Impact Sockets .....	125 - 126
Impact Socket Sets .....	127 - 130

### Adjustable Wrenches

Adjustable Wrenches .....	132 - 135
Pipe Wrenches .....	136



## Wrenches

Stubby Geared Ratcheting Wrenches .....	138
Fits-All Geared Ratcheting Wrenches .....	139
Geared Ratcheting Wrenches .....	140 - 141
Stubby Reversible Geared Ratcheting Wrenches .....	142
Reversible Geared Ratcheting Wrenches .....	143 - 144
Flex-Head Geared Ratcheting Wrenches .....	145
Double Flex-Head Geared Ratcheting Wrenches .....	146
S-Shape Box End Reversible Ratcheting Wrenches .....	147
4-in-1 Reversible Geared Ratcheting Wrenches .....	148
Fits-All Combination Wrenches .....	149 - 150
45-Degree Fits-All Box Wrenches .....	151
External Star Wrenches .....	152
"25-Degree Offset" Ratcheting Box Wrenches .....	153
Thin-Wall Combination Wrenches .....	154 - 155
Long Style / Stubby Combination Wrenches .....	156 - 157
Extra Long Combination Wrenches .....	158
"45-Degree Offset" Combination Wrenches .....	159
Thin-Wall Open End Wrenches .....	160
Flare Nut Wrenches .....	161
"75-Degree" Offset Box Wrenches .....	162
Extra Long / Half Moon Box Wrenches .....	163
Swivel Socket Wrenches .....	164
Angled Socket / Construction Wrenches .....	165
Crowfoot Wrenches .....	166 - 167
Lug Wrenches .....	168 - 170

## Torque Wrenches

Digital Torque Wrenches .....	172 - 173
Torque Wrenches .....	174 - 176, 180
Insert Tools .....	177
Torque Wrenches & Torque Screwdriver .....	178
Torque Multipliers (Hex Type) .....	179

## Hex Wrenches

Hex & Star Wrenches .....	182 - 188
Jumbo Size Wrenches .....	189
T-Handle Hex & Star Wrenches .....	190

## Screwdrivers

Screwdrivers .....	192 - 203
Go-Thru Screwdrivers .....	204 - 205
Insulated Screwdrivers .....	206
Specialty Screwdrivers .....	207 - 213
Pry Bar Sets .....	214

<b>Screwdriver Bit Sets .....</b>	<b>216 - 226</b>
-----------------------------------	------------------

## Pliers

High Leverage Pliers .....	228 - 231
Pliers .....	232 - 235
Offset Pliers .....	236
Arched Handle Pliers .....	237 - 238
Long Reach Pliers .....	239
Adjustable Water Pump Pliers .....	240
Snap Ring Pliers .....	241
Electronic Pliers .....	242



Wire Crimper / Stripper .....	242
Electronic Mini Pliers .....	243
Insulated Pliers & Insulated Pliers Sets .....	244 - 245
Locking Pliers .....	246 - 248
<b>Hammers</b> .....	250 - 256
<b>Tackers / Staplers</b> .....	258 - 260
<b>Knives</b>	
Utility Knives .....	262 - 263
Knives .....	264 - 265
Multi Tools .....	266
<b>Cutters</b> .....	267 - 269
<b>Scrapers</b> .....	269 - 270
<b>Magnetic Sweepers</b> .....	272 - 273
<b>Pickup Tools</b> .....	274 - 278
<b>Planes</b> .....	280
<b>Rasp File</b> .....	281
<b>Wood Chisels</b> .....	282
<b>Punches &amp; Chisels</b> .....	283 - 286
<b>Saws</b> .....	287 - 290
<b>Measuring Tools</b> .....	291 - 299
<b>Riveters</b> .....	300
<b>Clamps</b> .....	301 - 302
<b>Caulking Gun &amp; Nut Splitters</b> .....	303
<b>Nut Splitters &amp; Removers</b> .....	304
<b>Power Pullers &amp; Tie Downs</b> .....	305
<b>Brushes &amp; Hand Drills</b> .....	306
<b>Files</b> .....	308 - 309
<b>Calipers</b> .....	310
<b>Vises</b> .....	311
<b>Tap &amp; Die</b> .....	312 - 314
<b>Electric Glue Guns</b> .....	316
<b>Soldering Guns &amp; Accessories</b> .....	317 - 318
<b>Tubing Tools</b> .....	319 - 320
<b>Oil Filter Wrenches</b> .....	322 - 325
<b>Grease Guns &amp; Accessories</b> .....	326 - 328
<b>Hand-Operated Transfer Pumps</b> .....	329
<b>Fuel Tanks</b> .....	330
<b>Safety Wear</b> .....	332 - 337
<b>Masks</b> .....	338 - 339
<b>Mechanic's Gloves</b> .....	340
<b>LED Flashlights</b>	
Rechargeable Flashlights .....	342 - 344
Multi-Function Flashlights .....	344 - 349
Flashlights .....	350 - 354

## Garden Tools

<b>Garden Tools</b> .....	356 - 362
---------------------------	-----------

## Air Compressors & Air Tools

<b>Air Compressors</b> .....	364 - 367
<b>Air Ratchets</b> .....	368 - 370
<b>Air Impact Wrenches</b> .....	371 - 379
<b>Air Grinders</b> .....	380 - 385
<b>Air Sanders</b> .....	386 - 390
<b>Air Polishers</b> .....	391
<b>Air Screwdrivers</b> .....	392 - 393
<b>Air Drills</b> .....	394 - 395
<b>Air Hammers</b> .....	395 - 397
<b>Air Scalars</b> .....	398 - 399
<b>Air Cutting Tools</b> .....	400 - 402
<b>Air Riveters</b> .....	403
<b>Air Spray Guns</b> .....	404 - 407
<b>Air Brushes</b> .....	408
<b>Air Stapler / Nailer</b> .....	409 - 411
<b>Air Miscellaneous</b> .....	412 - 413
<b>Air Control Units</b> .....	414
<b>Air Blow Guns</b> .....	415 - 417
<b>Air Fittings</b> .....	418 - 421
<b>Air Accessories</b> .....	422 - 426

## Power Tools / Power Equipment / Power Accessories

<b>Power Tools</b> .....	428 - 444
<b>Power Equipment</b> .....	446 - 448
<b>Generators</b> .....	449 - 455
<b>Water Pumps</b> .....	456 - 457
<b>Pressure Washers</b> .....	458 - 460
<b>Power Accessories</b>	
Wire Brushes .....	461 - 463
Drill Bits .....	464 - 468
Hole Saws .....	469 - 471
Cutting Wheels .....	472
Saw Blades .....	473
Grinding Stones .....	474 - 476





## Automotive Specialty Tools

### Diagnostics & Chargers

Battery Analyzer .....	478
Battery Tester .....	478 - 479
Automotive Multimeter .....	479
Ignition Tools .....	480
Battery Charger .....	480

### Fuel Systems

Oil Pressure Sending Units .....	481 - 482
Fuel Line Disconnect Tools .....	482 - 486

### Engine

Engine Services Tools .....	487 - 496
Clutch Tools .....	496 - 497
Piston Ring Compressor .....	498 - 499
Engine Testers .....	500
Compression Tester .....	501 - 502
Hose Clamping Tools .....	503
Pullers .....	504 - 512

### Strut Tool

Coil Spring Compressor .....	513
------------------------------	-----

### Cooling Systems

Heater & Radiator Tools .....	514
Air Conditioning Service Tools .....	514 - 515

Body .....	516 - 523
------------	-----------

### Electrical

Battery Tools .....	524
Battery Tester .....	524 - 526
Ignition Tools .....	526 - 532
Distributor & Carburetor Tools .....	531
Feeler Gauge .....	533 - 535
Electrical Tool Kit .....	535

### Brake Services

Brake Spoon & Pliers .....	536 - 537
Brake Cylinder Hones .....	538
Brake Tools .....	538 - 542
Flaring Tools .....	542

### Drive Train & Suspension

Exhaust Tools .....	543
Seal Puller .....	543
Wheel Bearing Locknut Sockets .....	544 - 548
Suspension Service Tools .....	549 - 555
Tire Repair Tool .....	555 - 556

### General

Screw Extractors .....	557
Fasteners .....	557 - 558
Torque Extension Bar .....	559
General Tools .....	559 - 561



# Wagons & Chests Tool Sets

(FA Series)



Modular Storage Tray Sets



Full-extension ball bearing  
drawer slides open and  
close easier



## Heavy Duty Wheels

- 125mm diameter for easy crossing of obstacles
- Non-protruding wheels for easy manoeuvring around the workshop
- Two fixed wheels and two castors, one with brake



Anti-shock protection on  
all four corners



Central locking with two  
reversible keys provide  
security





1

**T47140** 177pc 7-Drawer Wagon Professional Tool Set



**T47201**



**Fits-All Sockets & Wrenches**

**SAE & Metric, 6pt/8pt/12pt Hex/Spline/E-TX/Square**

**One Socket Fits All Nuts & Bolts**

Measurement	Width	Depth	Height
Dimension (w/ Casters)	30.2"	766mm	18.3" 465mm 38.4" 975mm
5-Drawer	21"	533mm	15.4" 391mm 2.3" 58mm
1-Drawer	21"	533mm	15.4" 391mm 5.1" 128mm
1-Drawer	21"	533mm	15.4" 391mm 7.7" 195mm



**T45997**



**T45847**



**T40596**



**T42674**



**T42676**



**T22937**



**T28593**



**T28946**



**T28949**



**T32795**



**T29642**



**T20684**

**T47141 231pc 7-Drawer Wagon Professional Tool Set (Metric)**

Measurement	Width	Depth	Height
Dimension (w/ Casters)	30.2" 766mm	18.3" 465mm	38.4" 975mm
5-Drawer	21" 533mm	15.4" 391mm	2.3" 58mm
1-Drawer	21" 533mm	15.4" 391mm	5.1" 128mm
1-Drawer	21" 533mm	15.4" 391mm	7.7" 195mm

**T47201**

**T45120**
**T45429**
**T45495**

**A5617**
**T40596**
**T40694**

**T28593**
**T28946**
**T28949**

**T22937**
**T32795**
**T18408**

**T23347**
**T29642**
**T20684**





1

**T47142** 316pc 8-Drawer Wagon Professional Tool Set



**T47207**

Each Drawer Fits 4 Tool Tray Sets



Measurement	Width	Depth	Height
Dimension (w/ Casters)	32.9" 835mm	24.4" 620mm	40.5" 1030mm
7-Drawer	28.0" 710mm	15.4" 391mm	2.8" 70mm
1-Drawer	28.0" 710mm	15.4" 391mm	5.5" 140mm
2-Side Table	13.8" 350mm	15.0" 380mm	
1-Side Drawer	4.0" 100mm	23.5" 600mm	12.7" 325mm
1-Bottom Drawer	17.7" 450mm	16.3" 415mm	1.7" 45mm



**T45997**



**T45847**



**T45495**



**T33226**



**A5617**



**T29642**



**T41486**



**T42674**



**T42676**



**T40597**



**T40694**



**T22937**



T47142 Continue -

1



T32795



T32191



T28593



T28946



T46062



T28949



T22905



T22906



T29587



T18408



T23347



T20684



Ball Bearing Slide Construction

Sturdy extension side table

Side wall drawer for storage of long shaped tools

Push-button opens bottom drawer for parts storage



1

### T47108 122pc 4-Drawer Chest Professional Tool Set (Metric)



T47200



T45120



T45429



T42674



Measurement	Length	Width	Height
Dimension	27.2" 690mm	18.3" 465mm	15.7" 400mm
4-Drawer	21" 533mm	15.4" 391mm	2.3" 58mm



T40597



T28946



T28593



T28949



T32795



T20684

T47200 Tool Chest can be mounted on top of T47201 and T47204 tool wagons



### T47201 7-Drawer Wagon

Measurement	Width	Depth	Height
Dimension (w/ Casters)	30.2" 766mm	18.3" 465mm	38.4" 975mm
5-Drawer	21" 533mm	15.4" 391mm	2.3" 58mm
1-Drawer	21" 533mm	15.4" 391mm	5.1" 128mm
1-Drawer	21" 533mm	15.4" 391mm	7.7" 195mm



### T47200 4-Drawer Chest

- ABS worktop
- 4-Drawer on telescopic full-extension ball-bearing slides open and close easier as load increases
- 2 built-in lifting handles on the sides of the chest
- Centralized security locking and drawer catch system
- Anti-shock protection on all four corners

Measurement	Width	Depth	Height
Dimension	27.2" 690mm	18.3" 465mm	15.7" 400mm
4-Drawer	21" 533mm	15.4" 391mm	2.3" 58mm

### T47204 4-Drawer Wagon w/ Compartment

Measurement	Width	Depth	Height
Dimension (w/ Casters)	30.2" 766mm	18.3" 465mm	38.4" 975mm
3-Drawer	21" 533mm	15.4" 391mm	2.3" 58mm
1-Drawer	21" 533mm	15.4" 391mm	5.1" 128mm
1-Compartment	22.4" 570mm	16.1" 410mm	13" 330mm



**1**
**T47207 8-Drawer Professional Tool Wagon**

- Heavy-duty galvanized steel construction
- Centralized security locking and drawer catch system
- Each drawer fits 4 tool tray sets
- Tough, impact-resistant cover plate
- Sturdy extension side tables
- Push-button opens bottom drawer for parts storage
- Side wall drawer for storage of long shaped tools
- Anti-shock absorbers on all 4 walls
- Wide bottom increases cart stability and withstand heavy weight
- Safety lock system prevents more than one drawer opening at the same time

Measurement	Width	Depth	Height
Dimension (w/ Casters)	32.9" 835mm	24.4" 620mm	40.5" 1030mm
7-Drawer	28.0" 710mm	15.4" 391mm	2.8" 70mm
1-Drawer	28.0" 710mm	15.4" 391mm	5.5" 140mm
2-Side Table	13.8" 350mm	15.0" 380mm	
1-Side Drawer	4.0" 100mm	23.5" 600mm	12.7" 325mm
1-Bottom Drawer	17.7" 450mm	16.3" 415mm	1.7" 45mm

**T47206 6-Drawer Tool Cabinet**

- Ultra heavy-duty galvanized steel worktop on a 15mm thick impact resistant wooden base
- All drawers on telescopic full-extension ball-bearing slides open and closed easier as load increases
- Centralized security locking and drawer catch system
- 1-Lockable bin (with shelf) for storing aerosols, clearing products, bulky objects, etc.

Measurement	Width	Depth	Height
Dimension (w/ Casters)	44.5" 1130mm	22.4" 570mm	40" 1000mm
3-Drawer	21" 533mm	15.4" 391mm	2.3" 58mm
2-Drawer	21" 533mm	15.4" 391mm	5.1" 128mm
1-Drawer	21" 533mm	15.4" 391mm	7.7" 195mm



**Ultra heavy-duty galvanized steel worktop on a 15mm thick impact resistant wooden base**

**1 Lockable bin (with shelf) for storing aerosols, clearing products, bulky objects, etc.**

**Very large diameter wheels allowing the bench to easily ride over pipes and door rails, etc.**

**Compatible with the square hole range of side-mounted accessories**

## Workstations



Shutters can open and close for easy access and storage



**T47221**

### **T47220** Workstation with Shutter Storage

- Worktop length: 1500mm
- Surface width: 780mm
- Standard height: 830mm
- Effective shutter storage dimension: 1375 x 714 x 145mm

### **T47221** Workstation and 4-Drawer Tool Chest

- Worktop length: 1500mm
- Surface width: 780mm
- Standard height: 830mm
- Effective shutter storage dimension: 1375 x 714 x 145mm



**1**
**T47031 compartmentalized Shelf and Paper Roll Holder**

- compartmentalized shelf great for storing nuts, nails, bolts, etc.
- Paper roll holder design for hanging paper roll (paper not included)
- Dimensions: 305 x 305 x 145mm

**T47032 Documents Holder**

- Ideal for storing drawings, charts, documents, etc.
- Dimensions: 250 x 265 x 76mm

**T47033 Dustbin**

- Convenient for storing waste
- Dimensions: 300 x 300 x 190mm

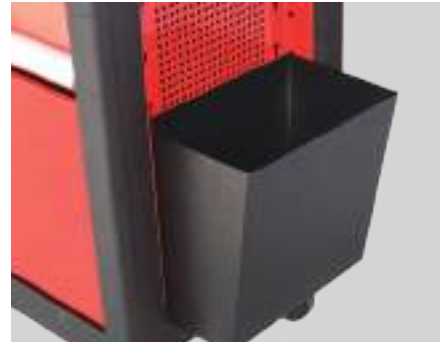
**T47034 Bottle Holder**

- Stores aerosols, cleaning products, sprays, etc.
- Dimensions: 250 x 110 x 80mm

**T47035 Side Cupboard**

- Perfect for storing long or expensive tools
- Compatible with the AmPro Hook system
- Key lock
- Dimensions: 685 x 302 x 85mm

**Divider**

- Provides compartment drawer space



Model	Dimensions
<b>T47036</b>	391 x 58 x 4mm
<b>T47037</b>	391 x 128 x 4mm

All above accessories are compatible with the FA-Series tool wagons and chests.



### Hooks

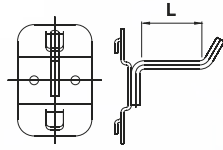

Model	L
T49932	40mm
T49933	75mm

### Double-Arm Hooks

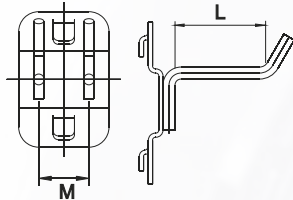

Model	L x M
T49934	40 x 20mm
T49935	75 x 20mm
T49936	75 x 30mm

### T47038 12-Compartment Tray

- Size:  
390 x 170 x 45mm (15" x 3.7" x 1.8")



All above accessories are compatible with the FA-Series tool wagons and chests.

**1**

## Wagon Tool Tray Program



Fits All FA-Series AmPro Wagons and Chests



**T45997** 52pc 1/4" & 3/8" Dr. Fits-All Socket Set



**T45847** 22pc 1/2" Dr. Fits-All Socket Set



**T45120** 52pc 1/4" & 3/8" Dr. Socket Set (Metric)



**T45429** 22pc 1/2" Dr. Socket Set (Metric)



**T45495** 17pc 1/4", 3/8" & 1/2" Deep Socket Set (6 - 32mm)



**A5617** 21pc 1/2" Dr. Impact Socket Set (13 - 24mm)



**T33226** 22pc 1/2" Dr. Star Bit Socket & External Star Socket Set



**T41486** 14pc Geared Comb. Wrench Set (8 - 19mm)





**T42674** 14pc Fits-All Comb. Wrench Set (6 - 24mm)



**T42676** 3pc Fits-All Comb. Wrench Set (27, 30, 32mm)



**T40597** 11pc Open-End & Ratcheting Box Wrench Set (6 x 7 - 20 x 22mm)



**T40596** 10pc Open-End Wrench Set (6 x 7 - 30 x 32mm)



**T40694** 6pc "75-Degree Offset" Box Wrench Set (8 x 9 - 18 x 19mm)



**T22937** 42pc Hex & Star Wrench Set (Metric & SAE)



**T22905** 7pc T-Handle Tamper-Proof Star & Star Wrench Set



**T22906** 7pc T-Handle Ball Point & Hex Wrench Set (Metric)



**T28593** 5pc High Leverage Pliers Set



**T28946** 3pc Pliers and Wrench Set



**T46062** 4pc Cutters and Scraper Set



**T28949** 4pc Snap Ring Pliers Set

**1**

**T32795** 7pc "Power Grip" Screwdriver Set



**T32191** 8pc Electrical Screwdriver Set (VDE)



**T29642** 11pc Punch & Chisel Set



**T29587** 5pc Wood Chisel & Rasp File Set



**T18408** 9pc Professional File Set



**T23347** 18pc Multi-Use Tool Set (Saw / Screwdriver / Knives / Tape Measures)



**T20684** 4pc Hammer, Chisel & Punch Set





# Wagons & Chests

# Tool Sets

(WA Series)







2

### T47130 69pc 1/4" & 3/8" Dr. Tool Set w/ 3-Tier Canti-Lever Metal Case (Metric)

- Heavy duty metal box for home and industrial use
- Professional grade tools for superior performance and durability
- 1/4" & 3/8" Dual-drive extendable ratchet
- Chrome Vanadium steel



Canti-Lever Handle Construction



Extra Storage Space Underneath Removable Tray



Measurement	Width	Depth	Height
Dimension	16" 410mm	8.7" 220mm	11.6" 295mm

### T47131 76pc 1/4" & 1/2" Dr. Tool Set w/ 5-Tier Canti-Lever Metal Case (Metric)

- Heavy duty metal box for home and industrial use
- Professional grade tools for superior performance and durability
- 1/4" & 1/2" quick-release offset ratchets
- Chrome Vanadium steel

Canti-Lever Handle Construction



Measurement	Width	Depth	Height
Dimension	18.5" 470mm	8.7" 220mm	14" 355mm



Extra Storage Space Underneath Removable Tray



**T47100 117pc 1/4" & 1/2" Dr. Professional 3-Drawer Tool Chest (Metric)**

- Assortment of professional grade tools
- Chrome Vanadium steel
- 72-Tooth industrial grade ratchets
- Heavy duty tool chest w/ sliding drawers
- Bonus drawer for added storage



**Heavy Duty Side Handles**



Measurement	Width	Depth	Height
Dimension	21.2" 540mm	10.1" 257mm	12.9" 328mm

**T47101 126pc 1/4", 3/8" & 1/2" Dr. Professional 3-Drawer Tool Set (SAE & Metric)**

- Assortment of professional grade tools
- Chrome Vanadium steel
- 72-Tooth industrial grade ratchets
- Heavy duty tool chest w/ sliding drawers
- Bonus drawer for added storage



**Heavy Duty Side Handles**



Measurement	Width	Depth	Height
Dimension	21.2" 540mm	10.1" 257mm	12.5" 328mm



**2**
**T47103 135pc 1/4" & 1/2" Dr. Professional 6-Drawer Tool Chest (Metric)**

Measurement	Width	Depth	Height
Dimension	26" 660mm	12" 305mm	15" 380mm
3-Drawer	6.7" 170mm	10.8" 275mm	1.6" 41mm
2-Drawer	22.4" 569mm	10.8" 275mm	1.6" 41mm
1-Drawer	22.4" 569mm	10.8" 275mm	2.5" 64mm

**Removable Tote Tray**

**T47064**

**T47105 99pc 1/4" & 3/8" Dr. Professional 6-Drawer Tool Chest (Metric)**

**T45033**
**T45239**
**Removable Tote Tray**

**T47064**

Measurement	Width	Depth	Height
Dimension	26" 660mm	12" 305mm	15" 380mm
3-Drawer	6.7" 170mm	10.8" 275mm	1.6" 41mm
2-Drawer	22.4" 569mm	10.8" 275mm	1.6" 41mm
1-Drawer	22.4" 569mm	10.8" 275mm	2.5" 64mm

**T40171**

**T28396**

**T28397**

**T22939**

**T32794**

**T23230**

**T47104 118pc 1/4", 3/8" & 1/2" Dr. Professional 5-Drawer Tool Chest (Metric)**

Measurement	Width	Depth	Height
Dimension	26" 660mm	18" 455mm	19" 483mm
2-Drawer	22.7" 576mm	16.1" 410mm	1.7" 44mm
3-Drawer	22.7" 576mm	16.1" 410mm	2.1" 54mm

**T47057**

**T47011**

**T45030**
**T45240**
**T45425**

**T40187**
**T28951**
**T28952**

**T32098**
**T18400**
**T20680**
**T47111 57pc 1/4" & 3/8" Dr. Professional 1-Drawer Tool Trolley (Metric)**

Measurement	Width	Depth	Height
Dimension (w/ Casters)	28.3" 720mm	16.1" 410mm	34.6" 880mm
1-Drawer	22.4" 569mm	10.8" 275mm	2.1" 54mm

**Drawer Fits 4 Tool Tray Sets**

**T45033**
**T45239**
**T40171**
**T28396**

**T47072**



**T47122 120pc 5-Drawer Wagon Professional Tool Set (Metric)**
**2**

**T47062**

- Quick Release Ratchets: 1/4", 3/8", 1/2" Dr.
- 1/4" Dr. 6pt Sockets: 5.5 - 14mm
- 3/8" Dr. 6pt Sockets: 8 - 22mm
- 1/2" Dr. 6pt Sockets: 10 - 32mm
- 75-Degree Box End Wrenches: 8 x 9 - 18 x 19mm
- Combination Wrenches: 6 - 24mm
- Slotted Screwdrivers: 3 x 60 - 8mm x 150mm
- Phillips Screwdrivers: #1 x 80, #2 x 100mm

**T45030**
**T45240**
**T45425**

Measurement	Width	Depth	Height
Dimension (w/ Casters)	26.3" 670mm	18.1" 460mm	30.3" 770mm
3-Drawer	22.7" 576mm	16.1" 410mm	2.1" 53mm
2-Drawer	22.7" 576mm	16.1" 410mm	5.3" 135mm

**T47011**

**T40693**
**T40187**
**T28951**

**T28952**
**T32098**
**T20680**





**T47125** 135pc 5-Drawer Wagon Professional Tool Set



**T47062**



**Fits-All Sockets & Wrenches**

**SAE & Metric, 6pt/8pt/12pt Hex/Spline/E-TX/Square**

**One Socket Fits All Nuts & Bolts**

SAE/Metric Hex

SAE/Metric Rounded Hex

Spline

E-TX

Square

- Quick Release Offset Ratchets: 1/4", 3/8", 1/2" Dr.
- Fits-All Sockets: 4.5 - 32mm (3/16" - 1-1/4")
- Fits-All Wrenches: 8 - 22mm (5/16" - 7/8")
- Slotted Screwdrivers: 3 x 60 - 8mm x 150mm
- Phillips Screwdrivers: #1 x 80, #2 x 100mm



**T45996**

Measurement	Width	Depth	Height
Dimension (w/ Casters)	26.3" 670mm	18.1" 460mm	30.3" 770mm
3-Drawer	22.7" 576mm	16.1" 410mm	2.1" 53mm
2-Drawer	22.7" 576mm	16.1" 410mm	5.3" 135mm



**T47011**



**T28964**



**T32098**



**T23346**



**T18400**



## T47123 196pc 5-Drawer Wagon Professional Tool Set (SAE & Metric)

2



T47062

- Quick Release Ratchets: 1/4", 3/8", 1/2" Dr.
- 1/4" Dr. 6pt Sockets: 5/32" - 9/16", 4 - 14mm
- 1/4" Dr. 6pt Deep Sockets: 1/4" - 7/16", 7 - 11mm
- 3/8" Dr. 6pt Sockets: 3/8" - 7/8", 10 - 19mm
- 3/8" Dr. 6pt Deep Sockets: 1/2" - 13/16", 10 - 16mm
- 1/2" Dr. 6pt Sockets: 3/4" - 1-1/8", 17 - 24mm
- 1/2" Dr. 6pt Deep Sockets: 3/4" - 15/16", 17 - 21mm
- Combination Wrenches:
  - 5/16" - 15/16", 8 - 18mm
- Slotted Screwdrivers:
  - 5 x 75 - 9.5mm x 200mm
- Phillips Screwdrivers:
  - #1 x 75, #2 x 100mm



T45535

Measurement	Width	Depth	Height
Dimension (w/ Casters)	26.3" 670mm	18.1" 460mm	30.3" 770mm
3-Drawer	22.7" 576mm	16.1" 410mm	2.1" 53mm
2-Drawer	22.7" 576mm	16.1" 410mm	5.3" 135mm



T46056



T28964



**T47120 116pc 5-Drawer Wagon Professional Tool Set (Metric)**

**T47062**

- Quick Release Offset Ratchets: 1/4", 1/2" Dr.
- 1/4" Dr. 6pt Sockets: 5.5 - 14mm
- 1/4" Dr. 6pt Deep Sockets: 6 - 13mm
- 1/2" Dr. 6pt Sockets: 10 - 32mm
- Combination Wrenches: 8 - 19mm
- Slotted Screwdrivers:
  - 3 x 60 - 8mm x 150mm
- Phillips Screwdrivers:
  - #1 x 80, #2 x 100mm

**T45032**
**T45425**
**T40179**

Measurement	Width	Depth	Height
Dimension (w/ Casters)	26.3" 670mm	18.1" 460mm	30.3" 770mm
3-Drawer	22.7" 576mm	16.1" 410mm	2.1" 53mm
2-Drawer	22.7" 576mm	16.1" 410mm	5.3" 135mm

**T47011**

**T28951**
**T28952**
**T32098**

**T46055**



**T47119 132pc 7-Drawer Wagon Professional Tool Set (Metric)**
**2**

**T47073**

- Quick Release Ratchets: 1/4", 3/8", 1/2" Dr.
- 1/4" Dr. 6pt Sockets: 5.5 - 14mm
- 3/8" Dr. 6pt Sockets: 8 - 22mm
- 1/2" Dr. 6pt Sockets: 10 - 32mm
- "75-Degree Offset" Box Wrenches: 8 x 9 - 18 x 19mm
- Combination Wrenches: 6 - 32mm
- Slotted Super Grip Screwdrivers: 3 x 60 - 8mm x 150mm
- Phillips Super Grip Screwdrivers: #1 x 80, #2 x 100mm

**T47011**

Measurement	Width	Depth	Height
Dimension (w/ Casters)	26.3" 670mm	18.1" 460mm	37" 943mm
5-Drawer	22.7" 576mm	16.1" 410mm	2.1" 53mm
2-Drawer	22.7" 576mm	16.1" 410mm	5.3" 135mm

**T45030**
**T45240**
**T45425**

**T40693**
**T40187**
**T40188**

**T28951**
**T28952**
**T28953**

**T20680**
**T18400**
**T32098**



**T47126** 155pc 7-Drawer Wagon Professional Tool Set (SAE & Metric)



**T47073**



**Fits-All Sockets & Wrenches**

**SAE & Metric, 6pt/8pt/12pt  
Hex/Spline/E-TX/Square**

**One Socket  
Fits All Nuts & Bolts**

SAE/Metric Hex  
SAE/Metric Rounded Hex  
Spline      E-TX  
Square

- Fits-All Sockets: 4.5 - 32mm (3/16" - 1-1/4")
- Fits-All Wrenches: 8 - 32mm (5/16" - 1-1/4")

Measurement Dimension (w/ Casters)	Width	Depth	Height
5-Drawer	26.3" 670mm	18.1" 460mm	37" 943mm
2-Drawer	22.7" 576mm	16.1" 410mm	5.3" 135mm



**T45996**



**T28964**



**T47011**

**T32098**

**T23346**

**T18400**



**T47011**

**T32190**

**T42678**

**T46059**





## T47116 135pc 7-Drawer Wagon Professional Tool Set (Metric)

2



**T47073**

- Quick Release Offset Ratchets: 1/4", 3/8", 1/2" Dr.
- 1/4" Dr. 6pt Sockets: 5.5 - 14mm
- 3/8" Dr. 6pt Sockets: 8 - 22mm
- 1/2" Dr. 6pt Sockets: 10 - 32mm
- 75-Degree Box End Wrenches: 8 x 9 - 18 x 19mm
- Combination Wrenches: 6 - 32mm
- Slotted Screwdrivers: 3 x 60 - 8mm x 150mm
- Phillips Screwdrivers: #1 x 80, #2 x 100mm
- Slotted Electrical Screwdrivers:
  - 0.4 x 2.5 x 75, 0.8 x 4 x 100, 1 x 5.5 x 125,
  - 1.2 x 6.5 x 150mm
- Phillips Electrical Screwdrivers:
  - #0 x 75, #1 x 80, #2 x 100mm



**T47011**

Measurement	Width	Depth	Height
Dimension (w/ Casters)	26.3" 670mm	18.1" 460mm	37" 943mm
5-Drawer	22.7" 576mm	16.1" 410mm	2.1" 53mm
2-Drawer	22.7" 576mm	16.1" 410mm	5.3" 135mm



**T45030**

**T45240**

**T45425**



**T40693**

**T40187**

**T40188**



**T28951**

**T28952**

**T32173**



**T20680**

**T18400**

**T32098**



**T47117** 228pc 10-Drawer Wagon Professional Tool Set (Metric)



**T47011**



**T45030**

**T45240**

**T45425**

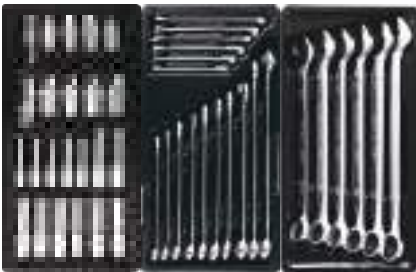

**T45208**

**T40182**

**T40192**



**T32095**

**T18407**

**T29656**



**T46055**



**T47084**

Measurement	Length	Width	Height
Dimension (w/ Casters)	26.3" 670mm	18.1" 460mm	37.8" 960mm
6-Drawer	22.7" 576mm	16.1" 410mm	1.7" 44mm
3-Drawer	22.7" 576mm	16.1" 410mm	2.1" 54mm
1-Drawer	22.7" 576mm	16.1" 410mm	4.6" 118mm



**T28964**



**T32179**



**T40193**



**T47121 244pc 13-Drawer Wagon Tool Set (Metric)**
**2**

**T47074**

- Fits-All Go-Thru Ratchets: 13mm, 19mm
- Fits-All Go-Thru Sockets: 4.5 - 13mm
- Fits-All Go-Thru Sockets: 10 - 19mm
- Quick Release Offset Ratchets: 1/4", 3/8", 1/2"
- 1/4" Dr. 6pt Sockets: 5.5 - 14mm
- 3/8" Dr. 6pt Sockets: 8 - 22mm
- 3/8" Dr. 6pt Deep Sockets: 7 - 11mm
- 1/2" Dr. 6pt Sockets: 10 - 32mm
- 1/2" Dr. 6pt Deep Sockets: 12 - 19mm
- Geared Combination Wrenches: 8 - 19mm
- Combination Wrenches: 6 - 32mm

Measurement	Width		Depth		Height	
Dimension (w/ Casters)	53"	1358mm	18.1"	460mm	45.3"	1150mm
10-Drawer	22.7"	576mm	16.1"	410mm	2.1"	54mm
2-Drawer	22.7"	576mm	16.1"	410mm	4.6"	118mm
1-Drawer	47.8"	1216mm	16.1"	410mm	4.6"	118mm

**T45030**
**T45240**
**T45425**

**T45207**
**T33225**
**T33224**

**T45822**
**T40941**
**T40693**

**T40187**
**T40188**
**T41489**

**T28952**
**T28953**
**T18400**

**T32098**
**T22903**
**T22904**





— Retail Program —  
Wagon / Chest Tool Tray Sets





Wagon Tool Program

2



**Build  
Your Own  
Wagon Sets**



**A** Tray Sets - Fits WA-Series AmPro Wagons and Chests with 410mm Depth Drawers



1/3 Drawer Trays



2



**T45032** 35pc 1/4" Dr. Socket Set (Metric)



**T45030** 37pc 1/4" Dr. Socket Set (Metric)



**T45013** 48pc 1/4" Dr. Socket Set (Metric)



**T45240** 19pc 3/8" Dr. Socket Set (Metric)



**T45425** 22pc 1/2" Dr. Socket Set (Metric)



**T45822** 33pc 1/4" & 3/8" Dr. Fits-All Go-Thru Socket Set



**T45207** 13pc 3/8" & 1/2" Dr. Deep Socket Set (Metric)



**T45208** 23pc 3/8" & 1/2" Dr. Deep Socket, Spark Plug Socket & Stud Puller Set



**T33224** 22pc 1/2" Dr. Star Bit Socket & External Star Socket Set



**T33225** 20pc 1/2" Dr. Hex Bit Socket Set



**A5616** 21pc 1/2" Dr. Impact Socket Set (13 - 24mm)



**T40179** 18pc Combination Wrench & Hex Key Set (8 - 19mm)



**1/3 Drawer Trays**
**A**
**2**

**T41489** 14pc Geared  
Combination Wrench Set  
(8 - 19mm)



**T41480** 11pc Geared  
Combination Wrench Set  
(10 - 22mm)



**T41496** 11pc Geared  
Combination Wrench Set  
(5/16" - 15/16")



**T40182** 16pc Combination  
Wrench Set (6 - 21mm)



**T40192** 6pc Combination  
Wrench Set (22 - 27mm)



**T40941** 6pc Flexible  
Socket Wrench Set  
(8 x 9 - 18 x 19mm)



**T40187** 16pc Combination  
Wrench Set (6 - 24mm)



**T40188** 4pc Combination  
Wrench Set (27 - 32mm)



**T42677** 14pc Fits-All  
Combination Wrench Set  
(6 - 24mm)



**T42678** 4pc Fits-All  
Combination Wrench Set  
(24 - 32mm)



**T40593** 9pc Open-End  
Wrench Set  
(6 x 7 - 24 x 27mm)



**T40693** 6pc "75-Degree  
Offset" Box Wrench Set  
(8 x 9 - 18 x 19mm)





1/3 Drawer Trays

**A**

**2**



**T22903** 7pc T-Handle Tamper-Proof Star & Star Wrench Set



**T22904** 7pc T-Handle Ball Point & Hex Wrench Set (Metric)



**T28950** 3pc Pliers Set



**T28952** 3pc Pliers Set



**T28954** 3pc Insulated Pliers Set (VDE 1000V)



**T28951** 3pc Pliers and Wrench Set



**T28953** 4pc Snap Ring Pliers Set



**T30902** 65pc Riveter Set

**T28955** (Left-Nut Adjustable Wrench)



**T28963** 3pc Pliers Set



**T28965** 3pc Long Reach Pliers Set



**T28966** 3pc Long Reach Hose Grip Pliers Set



**T46059** 8pc Electrical Precision Tool Set

**1/3 Drawer Trays**
**A**
**2**

**T32791** 7pc "Power Grip" Screwdriver Set (PH & Slotted)



**T32793** 8pc "Power Grip" Screwdriver Set (PH & Slotted)



**T32098** 7pc Super Grip Screwdriver Set (PH & Slotted)



**T32095** 8pc Super Grip Screwdriver Set (PH & Slotted)



**T32093** 7pc Super Grip Screwdriver Set (Star)



**T32185** 6pc Go-Thru Screwdriver Set (PH & Slotted)



**T32190** 8pc Electrical Screwdriver Set (VDE1000V)



**T32173** 7pc Electrical Screwdriver Set (VDE1000V)



**T20680** 7pc Hammer, Chisel & Punch Set



**T29656** 14pc Punch & Chisel Set



**T29654** 11pc Punch & Chisel Set



**T25608** 4pc Scrapers & Hammer Set



**1/3 Drawer Trays**

**T23346** 18pc Multi-Use Tool Set (Saw / Screwdriver / Knives / Tape Measures)



**T18400** 4pc 8" Pro Style File Set



**T18407** 9pc Engineer Files & External Thread Restorer File Set



**T46058** 14pc Oil Service Set (Metric)

**1/1 Drawer Trays**

**T45535** 108pc 1/4", 3/8" & 1/2" Dr. Socket Set (SAE & Metric)



**T45996** 94pc 1/4", 3/8" and 1/2" Dr. Fits-All Socket & Wrench Set (SAE & Metric)



**T40189** 5pc Jumbo Combination Wrench Set (36 - 55mm)



**T40193** 7pc Jumbo Combination Wrench Set (30 - 55mm)



## 1/1 Drawer Trays

A
2

**T28964** 12pc Master Pliers Set



**T46056** 76pc Screwdriver & Wrench Set (SAE & Metric)



**T46055** 28pc Multi-Use Tool Set



**T32179** 8pc Pry & Wrecking Bar Set

## Organizer Trays



**T47011** 1-Compartment Tray

- Size: 22.2" x 3" x 1.6" (564mm x 75mm x 40mm)



**T47012** 2-Compartment Tray

- Size: 13.4" x 7.3" (342mm x 185mm)

**T47013** 4-Compartment Tray

- Size: 13.4" x 7.3" (342mm x 185mm)

**T47014** 8-Compartment Tray

- Size: 13.4" x 7.3" (342mm x 185mm)

**T47010** 3pc Drawer Organizer Tray Set

- Size: 13.4" x 7.3" (342mm x 185mm)
- 1 - 2 Slots , 1 - 4 Slots , 1 - 8 Slots

## Chest Tool Program

2



**B** Tray Sets - Fits WA-Series AmPro Chests with 275mm Depth Drawers

 1/4 Drawer Trays **B**



**T45033** 31pc 1/4" Dr. Socket Set (Metric)



**T45085** 40pc 1/4" Dr. Socket Set (SAE & Metric)



**T45239** 16pc 3/8" Dr. Socket Set (Metric)



**T45285** 22pc 3/8" Dr. Socket Set (SAE & Metric)



**T40171** 8pc Combination Wrench Set (10-19mm)



**T40090** 8pc Combination Wrench Set (5/16" - 3/4")



**T22939** 27pc Hex & Star Wrench Set (Metric)



**T22938** 27pc Hex & Star Wrench Set (SAE & Metric)



1/4 Drawer Trays

B

2



**T41993** 5pc Flare Nut Wrench Set  
(9 x 11 - 16 x 18mm)



**T39820** 3pc Adjustable Wrench Set



**T39821** 3pc Adjustable Wrench Set



**T28391** 3pc Professional Pliers Set



**T28392** 3pc High Leverage Pliers Set



**T28396** 2pc Professional Pliers Set



**T28397** 2pc Professional Pliers Set



**T28958** 3pc High Leverage Pliers Set



**T73335** 4pc Snap Ring Pliers Set



**T32794** 5pc Screwdriver Set (PH & Slotted)



**T32164** 7pc Electrical Screwdriver Set (VDE100V)



**T32157** 17pc Precision Screwdriver Set



**1/4 Drawer Trays**
**B**
**2**

**T33273** 34pc Bits & Magnetic Tray Set



**T23230** 8pc Knife & Tape Set



**T29245** 5pc Measuring Tool Set



**T46060** 3pc Electrical Tool Kit



**T15810** 121pc Crimping Tool Set



**T35901** 17pc Tap & Die Set



**T46061** 8pc Telescopic & Pick Set

**1/2 Drawer Trays**
**B**

**T45408** 21pc 1/2" Dr. Socket Set (Metric)



**T32894** 8pc Comfort Grip Screwdriver Set (PH & Slotted)



**T28390** 5pc Professional Pliers Set

2

**T47002 Metal Case**



Measurement	Width	Depth	Height
Dimension	13.7" 350mm	7.7" 195mm	6.1" 155mm

**T47003 Metal Case**



Measurement	Width	Depth	Height
Dimension	17.1" 435mm	7.7" 195mm	7.2" 183mm

**T47004 3-Tier Canti-Lever Metal Case**



Measurement	Width	Depth	Height
Dimension	16" 410mm	8.7" 220mm	11.6" 295mm

**T47005 5-Tier Canti-Lever Metal Case**



Measurement	Width	Depth	Height
Dimension	18.5" 470mm	8.7" 220mm	14" 355mm

**T47049 4-Drawer Tool Chest**



Measurement	Width	Depth	Height
Dimension	21.2" 540mm	10.1" 257mm	12.9" 328mm
2-Drawer	8.4" 213mm	8.9" 225mm	1.5" 38mm
1-Drawer	18" 455mm	8.9" 225mm	1.5" 38mm
1-Drawer	18" 455mm	8.9" 225mm	2.1" 54mm

**T47052 3-Drawer Tool Chest**



Measurement	Width	Depth	Height
Dimension	26" 660mm	12" 305mm	9.8" 250mm
2-Drawer	22.4" 569mm	10.8" 275mm	1.6" 41mm
1-Drawer	22.4" 569mm	10.8" 275mm	2.5" 64mm



**T47064 6-Drawer Tool Chest**



Measurement	Width	Depth	Height
Dimension	26" 660mm	12" 305mm	15" 380mm
3-Drawer	6.7" 170mm	10.8" 275mm	1.6" 41mm
2-Drawer	22.4" 569mm	10.8" 275mm	1.6" 41mm
1-Drawer	22.4" 569mm	10.8" 275mm	2.5" 64mm

**T47059 4-Drawer Tool Chest**



Measurement	Width	Depth	Height
Dimension	26" 660mm	12" 305mm	15" 380mm
3-Drawer	22.4" 569mm	10.8" 275mm	1.6" 41mm
1-Drawer	22.4" 569mm	10.8" 275mm	2.5" 64mm

**T47057 5-Drawer Tool Chest**



Measurement	Width	Depth	Height
Dimension	26" 660mm	18" 455mm	19" 483mm
2-Drawer	22.7" 576mm	16.1" 410mm	1.7" 44mm
3-Drawer	22.7" 576mm	16.1" 410mm	2.1" 54mm

**T47066 6-Drawer Tool Chest**



Measurement	Width	Depth	Height
Dimension	26" 660mm	18" 455mm	19" 483mm
5-Drawer	22.7" 576mm	16.1" 410mm	1.7" 44mm
1-Drawer	22.7" 576mm	16.1" 410mm	2.1" 54mm



## 2 T47062 5-Drawer Tool Wagon

Measurement	Width	Depth	Height
Dimension (w/ Casters)	26.3" 670mm	18.1" 460mm	30.3" 770mm
3-Drawer	22.7" 576mm	16.1" 410mm	2.1" 53mm
2-Drawer	22.7" 576mm	16.1" 410mm	5.3" 135mm

A

Ball Bearing Slide Construction



B

Ball Bearing Slide Construction

## T47063 5-Drawer Tool Chest

Measurement	Width	Depth	Height
Dimension	26" 660mm	12" 305mm	17" 430mm
4-Drawer	22.4" 569mm	10.8" 275mm	1.6" 41mm
1-Drawer	22.4" 569mm	10.8" 275mm	2.5" 64mm

A

## T47078 6-Drawer Tool Wagon

Measurement	Width	Depth	Height
Dimension (w/ Casters)	26.3" 670mm	18.1" 460mm	30.3" 770mm
5-Drawer	22.7" 576mm	16.1" 410mm	2.1" 53mm
1-Drawer	22.7" 576mm	16.1" 410mm	5.3" 135mm

Ball Bearing Slide Construction



**T47073 7-Drawer Tool Wagon**

Measurement	Width	Depth	Height
Dimension (w/ Casters)	26.3" 670mm	18.1" 460mm	37" 943mm
5-Drawer	22.7" 576mm	16.1" 410mm	2.1" 53mm
2-Drawer	22.7" 576mm	16.1" 410mm	5.3" 135mm

**T47079 8-Drawer Tool Wagon**

Measurement	Width	Depth	Height
Dimension (w/ Casters)	26.3" 670mm	18.1" 460mm	37" 943mm
7-Drawer	22.7" 576mm	16.1" 410mm	2.1" 53mm
1-Drawer	22.7" 576mm	16.1" 410mm	5.3" 135mm

**T47084 10-Drawer Tool Wagon**

Measurement	Width	Depth	Height
Dimension (w/ Casters)	26.3" 670mm	18.1" 460mm	37.8" 960mm
6-Drawer	22.7" 576mm	16.1" 410mm	1.7" 44mm
3-Drawer	22.7" 576mm	16.1" 410mm	2.1" 54mm
1-Drawer	22.7" 576mm	16.1" 410mm	4.6" 118mm





2



**T47077 2-Drawer Tool Trolley**

Measurement	Width	Depth	Height
Dimension (w/ Casters)	30.2" 767mm	17.5" 445mm	35.6" 905mm
Top-Tray	28.1" 713mm	16" 405mm	3" 75mm
2-Drawer	26.8" 680mm	14.7" 375mm	3.7" 95mm
Bottom-Tray	28.1" 713mm	16" 405mm	3" 75mm



**T47072 1-Drawer Tool Trolley**

Measurement	Width	Depth	Height
Dimension (w/ Casters)	28.3" 720mm	16.1" 410mm	34.6" 880mm
1-Drawer	22.4" 569mm	10.8" 275mm	2.5" 64mm

**B**



**T47089 2-Drawer Sliding Top Tool Trolley**

Measurement	Width	Depth	Height
Dimension (w/ Casters)	29.3" 745mm	21.3" 540mm	39.4" 1000mm
2-Drawer	22.2" 565mm	13" 330mm	2" 50mm
2-Drawer	22.2" 565mm	13" 330mm	2" 50mm
1-Tray	27.6" 702mm	14.2" 360mm	3.3" 80mm





**T47088 3-Drawer Canti-Lever Tool Trolley**

Measurement	Width	Depth	Height
Dimension (w/ Casters)	50.8" 1290mm	17.3" 440mm	55.9" 1420mm
4-Tier	14.5" 368mm	9.3" 236mm	0.9" 24mm
Top-Tray	29.5" 756mm	16" 405mm	4" 100mm
1-Drawer	26.8" 680mm	14.6" 370mm	1.8" 45mm
1-Drawer	26.8" 680mm	14.6" 370mm	2.6" 65mm
1-Drawer	26.8" 680mm	14.6" 370mm	3.9" 99mm
Bottom-Tray	29.5" 756mm	16" 405mm	3" 74mm

**T47075 6-Drawer Heavy Duty Tool Cabinet**

Measurement	Width	Depth	Height
Dimension (w/ Bottom Stand)	26.3" 670mm	25.2" 640mm	44.7" 1135mm
5-Drawer	22.2" 564mm	22" 558mm	3.1" 78mm
1-Drawer	22.2" 564mm	22" 558mm	4.6" 118mm

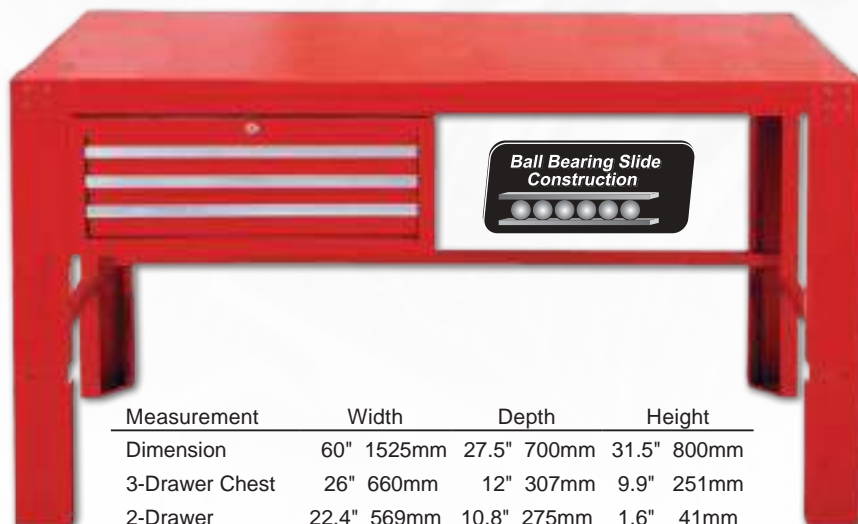
**T47085 Workstation with 3-Drawer Tool Chest**

**B**

Measurement	Width	Depth	Height
Dimension	60" 1525mm	27.5" 700mm	31.5" 800mm
3-Drawer Chest	26" 660mm	12" 307mm	9.9" 251mm
2-Drawer	22.4" 569mm	10.8" 275mm	1.6" 41mm
1-Drawer	22.4" 569mm	10.8" 275mm	2.5" 64mm



2



### T47086 11-Drawer Tool Cabinet

Measurement	Width	Depth	Height
Dimension (w/ Casters)	30" 764mm	19" 490mm	40.1" 1020mm
2-Drawer	11.7" 298mm	17.5" 446mm	2.7" 68mm
1-Drawer	24.7" 628mm	17.5" 446mm	2.7" 68mm
1-Drawer	24.7" 628mm	17.5" 446mm	4.6" 118mm

### 7 Drawers Side Cabinet

Measurement	Width	Depth	Height
Dimension (w/ Casters)	15" 382mm	18.1" 460mm	31.2" 795mm
5-Drawer	11.3" 288mm	15" 380mm	2.1" 54mm
2-Drawer	11.3" 288mm	15" 380mm	4.6" 118mm



### T47083 13-Drawer Heavy Duty Tool Cabinet



Measurement	Width	Depth	Height
Dimension (w/ Casters)	42"	18.1"	45.3"
5-Drawer	11.3"	16.1"	2.1"
	288mm	410mm	54mm
5-Drawer	22.7"	16.1"	2.1"
	576mm	410mm	54mm
1-Drawer	11.3"	16.1"	4.6"
	288mm	410mm	118mm
1-Drawer	22.7"	16.1"	4.6"
	576mm	410mm	118mm
1-Drawer	36.5"	16.1"	4.6"
	927mm	410mm	118mm



**T47074 13-Drawer Heavy Duty Tool Cabinet**



Measurement	Width	Depth	Height
Dimension (w/ Casters)	53" 1358mm	18.1" 460mm	45.3" 1150mm
10-Drawer	22.7" 576mm	16.1" 410mm	2.1" 54mm
2-Drawer	22.7" 576mm	16.1" 410mm	4.6" 118mm
1-Drawer	47.8" 1215mm	16.1" 410mm	4.6" 118mm

**Magnetic Side Hanging Trays**

Model	Size (mm)	Magnet
<b>T47026</b>	150(L) x 115(W) x 31(D)	1
<b>T47027</b>	210(L) x 115(W) x 31(D)	3
<b>T47028</b>	270(L) x 115(W) x 31(D)	2
<b>T47029</b>	310(L) x 115(W) x 31(D)	2
<b>T47018</b>	4pc Magnetic Side Hanging Tray Set	

**Magnetic Spray Can Holder w/ Screwdriver Insert Holes**

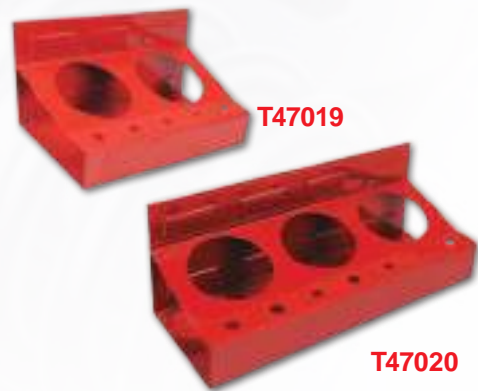
- Spray can holder for diameter 3" (76mm) bottles
- Strong magnet for firm attachment
- Screwdriver insert holes for convenience



Model	Spray Can	Screwdriver Hole
<b>T47019</b>	2	5
<b>T47020</b>	3	7



2

### Magnetic Socket Holder

- 18" (450mm) Aluminum rail



Model	Size
<b>T21105</b>	1/4" Dr.
<b>T21106</b>	3/8" Dr.
<b>T21107</b>	1/2" Dr.

### Magnetic Socket Holder

- Magnetic bracket and pre-drilled holes for quick mounting



Model	Size	Length
<b>T21108</b>	1/4" Dr.	8" (200mm)
<b>T21109</b>	3/8" Dr.	12" (300mm)
<b>T21110</b>	1/2" Dr.	12" (300mm)

### T47021 Magnetic Socket Holder

- Magnetic tools tray holds 3/8" or 1/2" Dr. sockets



\* Sockets not included

### T47024 15" Side Panel

- Side table and paper roll holder
- Made to fit on the side of tool wagons



\* Paper rolls not included

### T47022 7pc Magnetic Wrench Holder



\* Wrenches not included

### T47017 Magnetic Glove Dispenser

- Great for storing gloves of all sizes



### T47025 Side Bumpers

Rubber side bumper for added protection



### T47016 Foldable T-Bar Holder



### T47015 Magnetic Tissue Holder

- Versatile design holds different lengths of paper towels





# Aluminum Case / Trolley Tool Sets Tote Bags





3

## Aluminum Case / Trolley Tool Sets

- Assortment of professional grade tools
- Chrome Vanadium steel for superior performance longevity and durability
- Hardened, tempered steel for strength and durability
- Strong quick-release 72-tooth geared ratchets
- Cushioned grip handle
- Foam padding, fitted pockets and latches secure tools in position
- Heavy duty aluminum trolley case with extendable handle



### T45900 71pc Tool Set w/ Aluminum Trolley Case (Metric)

- Combination Wrenches: 8, 9, 10, 11, 12, 13, 14, 17, 19mm
- Screwdrivers:
  - Slotted: 6 x 38, 6 x 100, 6 x 150, 8mm x 150mm
  - Phillips: #1 x 75, #2 x 38, #2 x 100mm
  - Star Screwdrivers : T10, T15, T20, T25, T30
  - Precision Screwdrivers:
    - Slotted: 2 x 75, 2.5 x 75, 3mm x 75mm
    - Phillips: #0 x 75, #00 x 75mm





## T45902 122pc Tool Set w/ Aluminum Trolley Case (Metric)

- Quick Release Offset Ratchets: 1/4", 1/2"
- 1/4" Dr. 6pt Sockets: 4 - 14mm  
1/2" Dr. 6pt Sockets: 10 - 32mm
- Combination Wrenches: 8, 10, 12, 13, 14, 15, 17, 19, 22mm
- Screwdrivers:
  - Slotted: 8 x 150, 6 x 100, 6 x 38mm
  - Phillips: #1 x 75, #2 x 100, #2 x 38mm
  - Pozi: #1 x 75, #2 x 100mm



## T45901 136 pc Tool Set w/ Aluminum Trolley Case (SAE & Metric)

- Quick Release Ratchets: 1/4", 3/8"
- 1/4" Dr. 6pt Sockets: 3/16" - 1/2"  
1/4" Dr. 6pt Sockets: 4 - 12mm  
1/4" Dr. 6pt Deep Sockets: 6 - 10mm  
3/8" Dr. 6pt Sockets: 3/8" - 3/4"  
3/8" Dr. 6pt Sockets: 10 - 19mm  
3/8" Dr. 6pt Deep Sockets: 12 - 17mm
- Combination Wrenches: 8, 10, 12, 13, 14, 15, 17, 19, 22mm
- Screwdrivers:
  - Slotted: 8 x 150, 6 x 100, 6 x 38mm
  - Phillips: #1 x 75, #2 x 100, #2 x 38mm
  - Pozi: #1 x 75, #2 x 100mm





**T45912 34pc 1/2" Dr. Socket & Wrench Set  
w/ Aluminum Case (Metric)**

- Quick Release Offset Ratchet: 1/2"
- 1/2" Dr. 6pt Sockets: 8 - 32mm
- 1/2" Universal Joint
- 1/2" Dr. Universal Joint
- 1/2" Dr. Extensions: 125, 250mm
- 1/2" Dr. x 15" (380mm) Flexible Handle
- 3/8" Dr. (F) x 1/2" (M) Sliding T-Adaptor
- Combination Wrenches: 8, 10, 11, 12, 13, 14, 17, 19mm

3

**T45917 77pc 1/4" & 1/2" Dr. Socket Set  
w/ Aluminum Case (Metric)**

- Quick Release Offset Ratchets: 1/4", 1/2"
- 1/4" Dr. 6pt Sockets: 4 - 14mm
- 1/2" Dr. 6pt Sockets: 10 - 32mm
- Combination Wrenches: 8, 10, 11, 12, 13, 14, 17mm
- Screwdrivers:
  - Phillips: #2 x 4" (100mm)
  - Slotted: 1/4" x 6" (6 x 150mm)
- 1/4" Screwdriver Bits (25mm):
  - Phillips: #0, #1, #2, #3
  - Slotted: 4, 4.5, 5.5, 6mm
  - Hex: 3, 4, 5, 6, 7mm
  - Star: T10, T15, T20, T25, T27, T30, T40
  - Pozi: #0, #1, #2, #3



**T45907 81pc 1/4" & 3/8" Dr. Socket Set  
w/ Aluminum Case (SAE & Metric)**

- Quick Release Offset Ratchets: 1/4", 3/8"
- 1/4" Dr. 6pt Sockets: 3/16" - 1/2"
- 1/4" Dr. 6pt Sockets: 4 - 12mm
- 1/4" Dr. 6pt Deep Sockets: 6 - 10mm
- 3/8" Dr. 6pt Sockets: 3/8" - 3/4"
- 3/8" Dr. 6pt Sockets: 10 - 19mm
- 3/8" Dr. 6pt Deep Sockets: 12 - 17mm
- 1/4" Screwdriver Bits:
  - Phillips: #0, #1, #2, #3
  - Slotted: 4, 4.5, 5.5, 6mm
  - Hex: 3, 4, 5, 6, 7mm
  - Star: T10, T15, T20, T25, T27, T30, T40
  - Pozi: #0, #1, #2, #3



**T45909 80pc 1/4" & 3/8" Dr. Socket Set w/ Aluminum Case (SAE & Metric)**

- Quick Release Offset Ratchets: 1/4", 3/8"
- 1/4" Dr. 6pt Sockets: 3/16" - 1/2"  
1/4" Dr. 6pt Sockets: 4 - 12mm  
3/8" Dr. 6pt Sockets: 3/8" - 3/4"  
3/8" Dr. 6pt Sockets: 10 - 19mm  
3/8" Dr. 6pt Deep Sockets: 3/8" - 5/8"  
3/8" Dr. 6pt Deep Sockets: 12 - 18mm
- 1/4" Screwdriver Bits (25mm):  
Phillips: #0, #1, #2, #3  
Slotted: 4, 4.5, 5.5, 6mm  
Hex: 3, 4, 5, 6, 7mm  
Star: T10, T15, T20, T25, T27, T30, T40  
Pozi: #0, #1, #2, #3



**T45916 67pc 1/4" & 1/2" Dr. Socket Set w/ Aluminum Case (Metric)**

- Quick Release Offset Ratchets: 1/4", 1/2"
- 1/4" Dr. 6pt Sockets: 4 - 14mm  
1/2" Dr. 6pt Sockets: 10 - 32mm
- 1/4" Screwdriver Bits (25mm):  
Phillips: #0, #1, #2, #3  
Slotted: 3, 4, 5, 5.5, 6, 7mm  
Hex: 4, 5, 6mm  
Star: T15, T20, T25, T27, T30, T40  
Pozi: #1, #2, #3
- Aluminum Case

**T45911 48pc Electrical Tool Set w/ Aluminum Case**

- Insulated Screwdrivers:  
Slotted: #0 x 75mm, #2 x 100mm, #1 x 100mm,  
Phillips: 3mm x 75mm, 4 x 100mm, 5.5 x 125mm
- 175mm Insulated Heavy Duty Diagonal Cutting Pliers
- 200mm Insulated Combination Pliers
- 200mm Insulated Long Nose Pliers





### T11201 Heavy Duty Tool Tote Bag

- Large zippered storage compartment
- Convenient stay-open design
- Water-resistant bottom
- Wider opening for easier access to your tools
- Size: 17" (430mm)



### T11206 Heavy Duty Tool Tote Bag

- Water-resistant bottom
- Cushion grip stainless steel handle
- Easy vertical tool access design
- Includes interior and exterior pockets
- Removable shoulder strap
- Size: 16" (400mm)



### T11203 Heavy Duty Tool Tote Bag w/ Trolley

- Trolley with extendable handle
- Includes interior and exterior pockets
- Large zippered storage compartment
- Size: 20" (500mm)





# Fits-All Go-Thru Socket Sets

SAE & Metric, 6pt / 8pt / 12pt  
Hex / Spline / Square / E-TX



**Fits-All**  
Nuts & Bolts

**Less Sockets,  
More Sizes**

SAE / Metric  
Hex



SAE / Metric  
Rounded Hex



**One Socket  
Fits-All**

Square



Spline



E-TX



**Deep Socket Adaptor**  
Converts Standard  
to Deep Socket





### Fits-All Go-Thru Socket Set



## Fits-All Socket Sets

One Socket  
Fits-All  
Nuts & Bolts

## SAE & Metric, Standard & Deep Hex / Spline / E-TX / Square

- Go-Thru Design Reaches into Deep Recessed Areas
- 72-Tooth Geared Offset Reversible Ratchets

**SAE / Metric Hex**



**SAE / Metric Rounded Hex**



**Spline**



**E-TX**



**Square**



**STD → DEEP Sockets**

Extension Adaptor  
Converts Standard to Deep Socket



Quick-Release Ratchet Adaptor  
Converts Standard Ratchet to Traditional Ratchet



Bit Socket Adaptor  
Converts Bit to Bit Socket



Go-Thru Socket Adaptor Works w/ Standard Ratchets



### Fits-All Go-Thru Sockets Conversion Table

Size	6PT/12PT Hex (mm)	6PT Round Hex	6PT/12PT (Inch)	E-TX	Square	Spline
4.5mm	√	√	3/16"	E6	x	x
5mm	√	√	13/64"	x	4	M6
5.5mm	√	√	7/32"	x	4.5	x
6mm	√	√	1/4"	E8	5	M8
7mm	√	√	9/32"	x	x	x
8mm	√	√	5/16"	E10	x	x
9mm	√	√	11/32"	x	x	M10
10mm	√	√	3/8"	E12	8	M12
11mm	√	√	7/16"	E14	9	M14
12mm	√	√	15/32"	E16	10	x
13mm	√	√	1/2"	x	x	M16
14mm	√	√	9/16"	E18	x	x
15mm	√	√	19/32"	x	12	x
16mm	√	√	5/8"	E20	13	x
17mm	√	√	11/16"	x	14	x
18mm	√	√	23/32"	E22	x	x
19mm	√	√	3/4"	E24	x	x
20mm	√	√	25/32"	x	16	x
21mm	√	√	13/16"	E26	17	x
22mm	√	√	7/8"	E28	18	x
23mm	√	√	x	x	x	x
24mm	√	√	15/16"	E30	19	x
27mm	√	√	1-1/16"	E34	22	x
30mm	√	√	1-3/16"	E38	24	x
32mm	√	√	1-1/4"	E40	26	x





### T45980 62pc 1/4" & 3/8" Dr. Fits-All Go-Thru Socket Set (SAE & Metric, Standard & Deep)

- 13mm Fits-All Go-Thru Sockets: 4.5 - 13mm (3/16" - 1/2")
- 19mm Fits-All Go-Thru Sockets: 10 - 19mm (3/8" - 3/4")

Measurement	Width	Depth	Height
Dimension	17.1" 435mm	7.7" 195mm	7.2" 183mm



1/4" Dr.

3/8" Dr.



4

### T45981 82pc 1/4", 3/8" & 1/2" Dr. Fits-All Go-Thru Socket Set (SAE & Metric, Standard & Deep)

- 13mm Fits-All Go-Thru Sockets: 4.5 - 13mm (3/16" - 1/2")
- 19mm Fits-All Go-Thru Sockets: 11 - 19mm (3/8" - 3/4")
- 22mm Fits-All Go-Thru Sockets: 20 - 32mm (25/32" - 1-1/4")

Measurement	Length	Depth	Height
Dimension	21" 534mm	10" 254mm	12.5" 317mm



1/4" Dr.

3/8" Dr.

1/2" Dr.





4

### T45970 29pc 1/4" Dr. Fits-All Go-Thru Socket Set (SAE & Metric, Standard & Deep)

- 13mm Fits-All Go-Thru Sockets: 4.5 - 13mm (3/16" - 1/2")



1/4" Dr.



### T45809 37pc 1/4" Dr. Fits-All Go-Thru Socket Set (SAE & Metric, Standard & Deep)

- 13mm Fits-All Go-Thru Sockets: 4.5 - 12mm (3/16" - 15/32")



1/4" Dr.



### T45971 17pc 3/8" Dr. Fits-All Go-Thru Socket Set (SAE & Metric, Standard & Deep)

- 19mm Fits-All Go-Thru Sockets: 8 - 19mm (5/16" - 3/4")



3/8" Dr.



### T45972 56pc 1/4" & 3/8" Dr. Fits-All Go-Thru Socket Set (SAE & Metric, Standard & Deep)

- 13mm Fits-All Go-Thru Sockets: 4.5 - 13mm (3/16" - 1/2")
- 19mm Fits-All Go-Thru Sockets: 10 - 19mm (3/8" - 3/4")



1/4" Dr.

3/8" Dr.



3/8" Dr.

1/2" Dr.



### T45823 23pc 3/8" & 1/2" Dr. Fits-All Go-Thru Socket Set (SAE & Metric, Standard & Deep)

- 19mm Fits-All Go-Thru Sockets: 10 - 18mm (3/8" - 23/32")
- 22mm Fits-All Go-Thru Sockets: 19 - 32mm (3/4" - 1-1/4")
- 22mm Go-Thru Geared Reversible Ratchet (22mm x 19mm Go-Thru Socket can be used as an adaptor for 19mm Go-Thru Sockets)
- 1/2" Dr. Universal Joint
- 1/2" Dr. Spark Plug Sockets: 16, 21mm
- 1/2" Dr. x 125mm Extension Bar
- 22mm Go-Thru Deep Socket Adaptor
- 1/2" Dr. x 22mm Quick-Release Ratchet Adaptor



**T45825 80pc 1/4" & 3/8" Dr. Fits-All Go-Thru Socket & Tool Set (SAE & Metric, Standard & Deep)**

- 13mm Fits-All Go-Thru Sockets: 4.5 - 13mm (3/16" - 1/2")  
19mm Fits-All Go-Thru Sockets: 10 - 19mm (3/8" - 3/4")
- Go-Thru Geared Reversible Ratchets: 13, 19mm
- Universal Joints: 1/4" & 3/8" Dr.
- 3/8" Dr. Spark Plug Sockets: 5/8", 13/16" (16, 21mm)
- Extension Bars: 1/4" x 4" (100mm), 3/8" x 3" (75mm)
- 170mm Long Nose Pliers
- 170mm Diagonal Cutting Pliers
- "Fits-All" Combination Wrenches: 8, 10, 12, 13, 14, 17mm
- Go-Thru Socket Adaptors: 1/4" Dr. x 13mm, 3/8" Dr. x 19mm
- Go-Thru Deep Socket Adaptors: 13, 19mm
- 3/8" x 19mm Quick-Release Ratchet Adaptor
- 1/4" Dr. Ratchet & Bit Adaptor
- Stubby Geared Bit Driver w/ Bits Storage
- 22 - 1/4" Screwdriver Bits



**T45821 60pc 1/4" & 3/8" Dr. Fits-All Go-Thru Socket Set (SAE & Metric, Standard & Deep)**

- 13mm Fits-All Go-Thru Sockets: 4.5 - 13mm (3/16" - 1/2")  
19mm Fits-All Go-Thru Sockets: 10 - 19mm (3/8" - 3/4")
- Go-Thru Geared Reversible Ratchets: 13, 19mm
- Universal Joints: 1/4", 3/8"
- 3/8" Dr. Spark Plug Sockets: 16mm, 21mm
- Extension Bars:  
1/4" Dr. x 4" (100mm), 3/8" Dr. x 3" (75mm)
- Go-Thru Socket Adaptors:  
1/4" Dr. x 13mm, 3/8" Dr. x 19mm
- Go-Thru Deep Socket Adaptors: 13, 19mm
- Quick-Release Ratchet Adaptors: 1/4" Dr. x 13mm, 3/8" Dr. x 19mm
- Stubby Geared Bit Driver w/ Bit Storage
- 1/4" Bit Coupler
- 22 - 1/4" Screwdriver Bits



**T45974 40pc 1/4", 3/8" & 1/2" Dr. Fits-All Go-Thru Socket Set (SAE & Metric, Standard & Deep)**

- 13mm Fits-All Go-Thru Sockets: 4.5 - 13mm (3/16" - 1/2")  
19mm Fits-All Go-Thru Sockets: 10 - 19mm (3/8" - 3/4")  
22mm Fits-All Go-Thru Sockets: 20 - 32mm (25/32" - 1-1/4")
- Go-Thru Geared Reversible Ratchets:  
13mm, 19mm, 22mm
- Go-Thru Deep Socket Adaptors: 13, 19, 22mm
- Quick-Release Ratchet Adaptors:  
1/4" Dr. x 13mm, 3/8" Dr. x 19mm, 1/2" Dr. x 22mm
- Go-Thru Socket Adaptors:  
1/4" Dr. x 13mm, 3/8" Dr. x 19mm, 1/2" Dr. x 22mm
- 1/4" x 13mm Bit Coupler

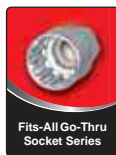





4



### T45831 50pc 1/4", 3/8" & 1/2" Dr. Fits-All Go-Thru Socket Set (SAE & Metric, Standard & Deep)

- 13mm Fits-All Go-Thru Sockets: 4.5 - 13mm (3/16" - 1/2")
- 19mm Fits-All Go-Thru Sockets: 10 - 19mm (3/8" - 3/4")
- 22mm Fits-All Go-Thru Sockets: 20 - 32mm (25/32" - 1-1/4")
- Go-Thru Geared Reversible Ratchets: 13, 19, 22mm
- Universal Joints: 1/4", 3/8", 1/2" Dr.
- 3/8" Dr. Spark Plug Sockets: 16, 21mm
- Extension Bars:
  - 1/4" Dr. x 100mm, 3/8" Dr. x 75mm, 1/2" Dr. x 125mm
- Go-Thru Deep Socket Adaptors: 13, 19, 22mm
- Go-Thru Socket Adaptors:
  - 1/4" Dr. x 13mm, 3/8" Dr. x 19mm, 1/2" Dr. x 22mm
- Quick-Release Ratchet Adaptors: 3/8" Dr. x 19mm, 1/2" Dr. x 22mm
- 1/4" Dr. Ratchet & Bit Adaptor



### T45973 73pc 1/4", 3/8" & 1/2" Dr. Fits-All Go-Thru Socket Set (SAE & Metric, Standard & Deep)

- 13mm Fits-All Go-Thru Sockets: 4.5 - 13mm (3/16" - 1/2")
- 19mm Fits-All Go-Thru Sockets: 10 - 19mm (3/8" - 3/4")
- 22mm Fits-All Go-Thru Sockets: 20 - 32mm (25/32" - 1-1/4")
- Go-Thru Geared Reversible Offset Ratchets: 13mm, 19mm, 22mm
- Go-Thru Deep Socket Adaptors: 13, 19, 22mm
- Quick-Release Ratchet Adaptors: 1/4" Dr. x 13mm, 3/8" Dr. x 19mm, 1/2" Dr. x 22mm
- Go-Thru Socket Adaptors: 1/4" Dr. x 13mm, 3/8" Dr. x 19mm, 1/2" Dr. x 22mm
- Fits-All Combination Wrenches: 8, 10, 12, 13, 14, 17, 19mm
- Extension Bars: 1/4" Dr. x 4" (100mm), 3/8" Dr. x 3" (75mm)
- 1/4" Dr. Spinner Handle
- 1/4" Screwdriver Bits (25mm)



### T45836 97pc 1/4", 3/8" & 1/2" Dr. Fits-All Go-Thru Socket and Tool Set (SAE & Metric, Standard & Deep)

- 13mm Fits-All Go-Thru Sockets: 4.5 - 13mm (3/16" - 1/2")
- 19mm Fits-All Go-Thru Sockets: 10 - 19mm (3/8" - 3/4")
- 22mm Fits-All Go-Thru Sockets: 20 - 24mm (25/32" - 15/16")
- 22mm 1/2" Dr. 6pt Sockets: 27, 30, 32mm
- Go-Thru Geared Reversible Ratchets: 13, 19, 22mm
- Fits-All Combination Wrenches: 10, 12, 13, 14, 17mm
- 150mm Long Nose Pliers
- 150mm Diagonal Cutting Pliers
- 175mm Combination Pliers
- 200mm Adjustable Wrench
- 1/4" Screwdriver Bits





# Fits-All Socket Sets

SAE & Metric, 6pt / 8pt / 12pt  
Hex / Spline / Square / E-TX



**Fits-All**  
Nuts & Bolts

**Less Sockets,  
More Sizes**



SAE/Metric  
Hex

SAE/Metric  
Rounded Hex

Spline

E-TX

Square





### Fits-All Socket Sets



## Fits-All Socket Sets

## SAE & Metric, 6pt / 8pt / 12pt Hex / Spline / E-TX / Square

SAE / METRIC  
HEX



SAE / METRIC  
ROUNDED HEX



SPLINE



E-TX

SQUARE



One Socket  
**Fits-All**  
Nuts & Bolts

Specially Designed  
Sockets Fits-All  
Shapes of Fasteners

### Fits-All Sockets Conversion Table

Size	6PT/12PT Hex (mm)	6PT Round Hex	6PT/12PT (Inch)	E-TX	Square	Spline
4mm	✓	✓	x	x	x	x
4.5mm	✓	✓	3/16"	E6	x	x
5mm	✓	✓	13/64"	x	4	M6
5.5mm	✓	✓	7/32"	x	4.5	x
6mm	✓	✓	1/4"	E8	5	M8
7mm	✓	✓	9/32"	x	x	x
8mm	✓	✓	5/16"	E10	x	x
9mm	✓	✓	11/32"	x	x	M10
10mm	✓	✓	3/8"	E12	8	M12
11mm	✓	✓	7/16"	E14	9	M14
12mm	✓	✓	15/32"	E16	10	x
13mm	✓	✓	1/2"	x	x	M16
14mm	✓	✓	9/16"	E18	x	x
15mm	✓	✓	19/32"	x	12	x
16mm	✓	✓	5/8"	E20	13	x
17mm	✓	✓	11/16"	x	14	x
18mm	✓	✓	23/32"	E22	x	x
19mm	✓	✓	3/4"	E24	x	x
20mm	✓	✓	25/32"	x	16	x
21mm	✓	✓	13/16"	E26	17	x
22mm	✓	✓	7/8"	E28	18	x
23mm	✓	✓	x	x	x	x
24mm	✓	✓	15/16"	E30	19	x
27mm	✓	✓	1-1/16"	E34	22	x
30mm	✓	✓	1-3/16"	E38	24	x
32mm	✓	✓	1-1/4"	E40	26	x



**T45840 14pc 1/4" Dr. Fits-All Socket Set (SAE & Metric)**

- Contents:
  - 11 - 1/4" Dr. Fits-All Sockets: 4.5, 5, 5.5, 6, 7, 8, 9, 10, 11, 12, 13mm (3/16" - 1/2")
  - 1 - 1/4" Dr. Quick-Release Ratchet (T29860)
  - 1 - 1/4" Dr. Universal Joint
  - 1 - 1/4" Dr. x 3" (75mm) Extension Bar



1/4" Dr.

**T45843 13pc 3/8" Dr. Fits-All Socket Set (SAE & Metric)**

- Contents:
  - 10 - 3/8" Dr. Fits-All Sockets: 8, 10, 12, 13, 14, 15, 16, 17, 18, 19mm (5/16" - 3/4")
  - 1 - 3/8" Dr. Quick-Release Ratchet (T29861)
  - 1 - 3/8" Dr. Universal Joint
  - 1 - 3/8" Dr. x 3" (75mm) Extension Bar



3/8" Dr.

**T45846 11pc 1/2" Dr. Fits-All Socket Set (SAE & Metric)**

- Contents:
  - 8 - 1/2" Dr. Fits-All Sockets: 15, 16, 17, 18, 19, 21, 22, 24mm (19/32" - 15/16")
  - 1 - 1/2" Dr. Quick-Release Ratchet (T29862)
  - 1 - 1/2" Dr. Universal Joint
  - 1 - 1/2" Dr. x 5" (125mm) Extension Bar



1/2" Dr.

**T45990 36pc 1/4" Dr. Fits-All Socket Set (SAE & Metric)**

- 1/4" Dr. Fits-All Sockets: 4.5 - 13mm (3/16" - 1/2")



1/4" Dr.

**T45994 18pc 3/8" Dr. Fits-All Socket Set (SAE & Metric)**

- 3/8" Dr. Fits-All Sockets: 8 - 19mm (5/16" - 3/4")



3/8" Dr.

4

**T45991 33pc 1/4" & 3/8" Dr. Fits-All Socket Set (SAE & Metric)**

- 1/4" Dr. Fits-All Sockets: 4 - 11mm (5/32" - 7/16")
- 3/8" Dr. Fits-All Sockets: 12 - 19mm (15/32" - 3/4")



1/4"  
Dr.

3/8"  
Dr.

**T45995 51pc 1/4" & 3/8" Dr. Fits-All Socket Set (SAE & Metric)**

- 1/4" Dr. Fits-All Sockets: 4.5 - 13mm (3/16" - 1/2")
- 3/8" Dr. Fits-All Sockets: 10 - 19mm (3/8" - 3/4")



1/4"  
Dr.

3/8"  
Dr.

**T45993 21pc 1/2" Dr. Fits-All Socket Set (SAE & Metric)**

- 1/2" Dr. Fits-All Sockets: 10 - 32mm (3/8" - 1-1/4")



1/2"  
Dr.

**T45992 26pc 1/2" Dr. Fits-All Socket Set (SAE & Metric)**

- 1/2" Dr. Fits-All Sockets: 8 - 32mm (5/16" - 1-1/4")



1/2"  
Dr.



1/4"  
Dr.

3/8"  
Dr.

1/2"  
Dr.

**T45999 45pc 1/4", 3/8" & 1/2" Dr. Fits-All Socket Set (SAE & Metric)**

- 1/4" Dr. Fits-All Sockets: 4.5 - 7mm (3/16" - 9/32")
- 3/8" Dr. Fits-All Sockets: 8 - 19mm (5/16" - 3/4")
- 1/2" Dr. Fits-All Sockets: 21 - 24 (13/16" - 15/16")







# Ratchets & Accessories

Innovative Design

Durability and Performance





AmPro offers a wide range of high quality, innovative designed ratchets. All ratchets are made of commercial-grade Chrome Vanadium steel. Precision 72-tooth quick-release ratchets release sockets with a smooth one-handed operation.

5

### Mini 1/4" Ratchet and Bit Driver



Model	Size	Length
<b>T29871</b>	1/4"	4-3/8" 110mm

### Stubby Bit Driver

- Fits 3/8" (10mm) Bits



Model	Size	Length
<b>T32100</b>	3/8" (10mm) Hex	5-3/8" 136mm

### Stubby Ratchets



Model	Size	Length
<b>T29850</b>	1/4"	4-3/8" 110mm
<b>T29851</b>	3/8"	5-1/4" 135mm
<b>T29852</b>	1/2"	6-3/4" 170mm

### Dual-Drive Stubby Ratchets



Model	Size	Length
<b>T29872</b>	1/4" & 3/8"	4-3/8" 135mm
<b>T29876</b>	3/8" & 1/2"	5-1/4" 135mm
<b>T29875</b>	3/8" & 1/2" (Jumbo)	6-3/4" 170mm

### Dual-Drive "Safety Lock" Stubby Flex Ratchets



Model	Size	Length
<b>T29873</b>	1/4" & 3/8"	6" 154mm
<b>T29874</b>	3/8" & 1/2"	6" 154mm

### Standard Ratchets



Model	Size	Length
<b>T29818</b>	1/4"	5-3/4" 147mm
<b>T29819</b>	3/8"	7-3/4" 197mm
<b>T29820</b>	1/2"	10-7/16" 265mm

### Dual-Drive Standard Ratchets



Model	Size	Length
<b>T29848</b>	1/4" & 3/8"	7-3/4" 197mm
<b>T29849</b>	3/8" & 1/2" (Jumbo)	10-7/16" 265mm

### Offset Ratchets



Model	Size	Length
<b>T29860</b>	1/4"	5-7/8" 145mm
<b>T29861</b>	3/8"	8-1/16" 205mm
<b>T29862</b>	1/2"	10" 252mm

## Heavy Duty Flex Ratchets

- 36-Tooth, geared action
- Chrome Vanadium steel
- Forward and reverse

Model	Size	Length
<b>T29913</b>	1/4"	7" 180mm
<b>T29914</b>	3/8"	10-1/8" 255mm
<b>T29915</b>	1/2"	12" 305mm
<b>T29916</b>	1/2"	24" 610mm

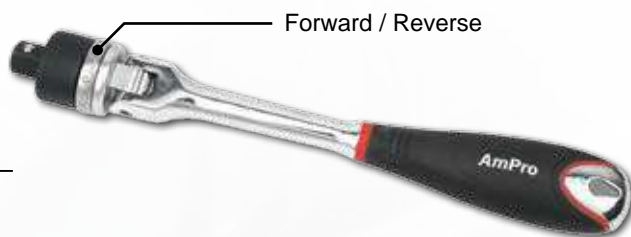

## Heavy Duty Extendable Flex Ratchets

- 36-Tooth, geared action
- Chrome Vanadium steel
- Forward and reverse
- 180° Swivel handle
- Cushioned grip handle

Model	Size	Locking Position	Length
<b>T29928</b>	1/4"	3	7-3/4" (195mm) to 9-5/8" (245mm)
<b>T29929</b>	3/8"	4	10-3/4" (270mm) to 14-3/4" (375mm)
<b>T29930</b>	1/2"	6	14-1/2" (365mm) to 20" (510mm)
<b>T29931</b>	1/2"	4	18" (455mm) to 24" (610mm)

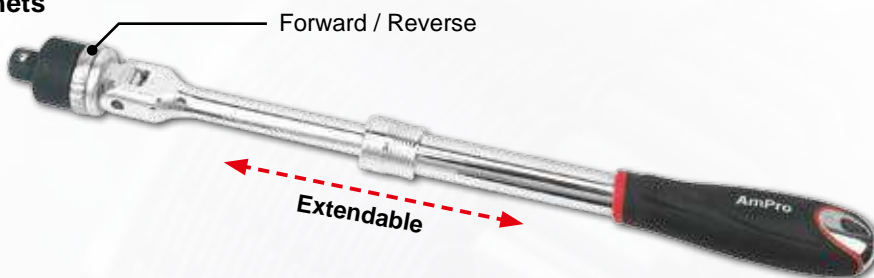

## "Safety Lock" Flex Head Ratchets



Model	Size	Length
<b>T29856</b>	1/4"	6-1/4" 159mm
<b>T29857</b>	3/8"	9-1/2" 242mm
<b>T29858</b>	1/2"	11-7/16" 290mm

## Dual-Drive "Safety Lock" Flex Head Ratchets



Model	Size	Length
<b>T29845</b>	1/4" & 3/8"	9-1/2" 242mm
<b>T29846</b>	3/8" & 1/2" (Jumbo)	11-7/16" 290mm

## Slim Head Quick Release Ratchets



Model	Size	Length
<b>T29866</b>	1/4"	4-1/2" 110mm
<b>T29867</b>	3/8"	6-1/8" 155mm
<b>T29868</b>	1/2"	8-1/4" 210mm

## High Torque Ratchets



Model	Size	Length
<b>T29836</b>	1/4"	5-7/8" 145mm
<b>T29837</b>	3/8"	7-11/16" 195mm
<b>T29838</b>	1/2"	10" 250mm



5

### Offset Ratchets with Disc



Model	Size	Length
T49833	1/4"	6" 150mm
T49834	3/8"	8-3/16" 208mm
T49835	1/2"	10-11/16" 253mm

### Finger Spinner Ratchet



Model	Size	Length
T29808	3/8"	8-13/16" 208mm

### 360-Degree Quick Release Ratchets



Model	Size	Length
T29877	1/4"	7-1/4" 185mm
T29878	3/8"	9-5/8" 245mm
T29879	1/2"	12-3/16" 310mm

### Double Flex Quick Release Ratchet



Model	Size	Length
T29828	3/8"	9-7/8" 250mm

### Stubby Spinner Ratchets

- Spinner head allows to work in multi-angle positions
- Stubby design for working in confined areas



Model	Size	Length
T29790	1/4"	4-1/8" 105mm
T29791	3/8"	6" 154mm
T29792	1/2"	7" 178mm

### Spinner Ratchets

- Spinner head allows to work in multi-angle positions
- Extended length for added leverage and torque



Model	Size	Length
T29793	1/4"	6" 157mm
T29794	3/8"	9-1/4" 235mm
T29795	1/2"	10-7/16" 265mm

### Lightweight Quick-Release Ratchets

- Lightweight, durable body reduces operator fatigue
- Material design offers anti-static capacity when working w/ non-conductive tools/parts



Model	Size	Length
T29815	1/4"	5-13/16" 148mm
T29816	3/8"	7-7/8" 200mm
T29817	1/2"	10-1/8" 257mm







### "Box Style" Ratchets



Model	Size	Length
T29809	1/4" (44-Tooth)	6" 150mm
T29810	3/8" (44-Tooth)	8" 202mm
T29811	1/2" (45-Tooth)	10-5/8" 270mm

### 3/8" Dr. Stubby Ratchet & Ratchet Head



\* Flex Handle not Included

Model	Size	Length
T29839	3/8"	2-3/16" 74mm

### Micro Offset Ratchet



Model	Size	Length
T29779	1/4"	3-3/4" 96mm

### Micro Ratchet & Bit Driver



Model	Size	Length
T29778	1/4"	3-3/8" 85mm

### Micro Quick-Release Ratchets



Model	Size	Length
T29747	1/4"	3-3/8" 85mm
T29748	3/8"	4-1/8" 105mm
T29749	1/2"	5-1/2" 140mm

### Dual-Drive Micro Ratchets



Model	Size	Length
T29830	1/4" & 3/8"	4-1/8" 105mm
T29831	3/8" & 1/2"	4-1/8" 105mm

### T29832 2pc 1/4" Dr. & 3/8" Dr. Micro Ratchet Set

- Palm-sized compact design
- Knurled handle for firm grip
- Quick-Release



Palm-sized Compact Design



5

### 1/4" Dr. Finger Ratchet & Bit Driver



\* Socket & bit not included

Bit Driver

Model	Size	Length
<b>T29780</b>	1/4"	2" 50mm

### Dual-Drive Finger Ratchet

\* Sockets not included



Model	Size	Length
<b>T29859</b>	1/4" & 3/8"	1-15/16" 47mm

### T29869 2pc Compact Ratchet Set



- Rapid dual-drive action
- Ribbed handles for greater finger control
- Mini-sized for quick fastening rotation in tight areas



### Regular Ratchets



Model	Size	Length
<b>T29800</b>	1/4" (43-Tooth)	5-1/2" 140mm
<b>T29801</b>	3/8" (41-Tooth)	8" 200mm
<b>T29802</b>	1/2" (45-Tooth)	10" 250mm

### "Metal Grip" Ratchets



Model	Size	Length
<b>T29824</b>	1/4"	5" 127mm
<b>T29825</b>	3/8"	7" 178mm
<b>T29826</b>	1/2"	10" 258mm

### Extra Long Ratchets



Model	Size	Length
<b>T29756</b>	1/4"	6-3/8" 157mm
<b>T29757</b>	3/8"	11-1/2" 290mm
<b>T29758</b>	1/2"	17-3/4" 450mm

### Extra Long Flex Head Ratchets



Model	Size	Length
<b>T29821</b>	1/4"	6-3/8" 157mm
<b>T29822</b>	3/8"	11-1/2" 290mm
<b>T29823</b>	1/2"	17-3/4" 450mm

## Heavy Duty Reversible Ratchet



- 24-Tooth

Model	Size	Length
<b>T29880</b>	3/4"	20" 500mm

## Industrial Reversible Ratchet



- 24-Tooth

Model	Size	Length
<b>T29890</b>	1"	26" 650mm

## Industrial Reversible Quick-Release Ratchet



Model	Size	Length
<b>T29881</b>	3/4"	20" 500mm

## Industrial Reversible Quick-Release Extendable Ratchets



Model	Size	Length
<b>T29885</b>	3/4"	20" (500mm) to 32" (800mm)
<b>T29895</b>	1"	20" (500mm) to 32" (800mm)

## Flex Ratcheting Socket Wrenches

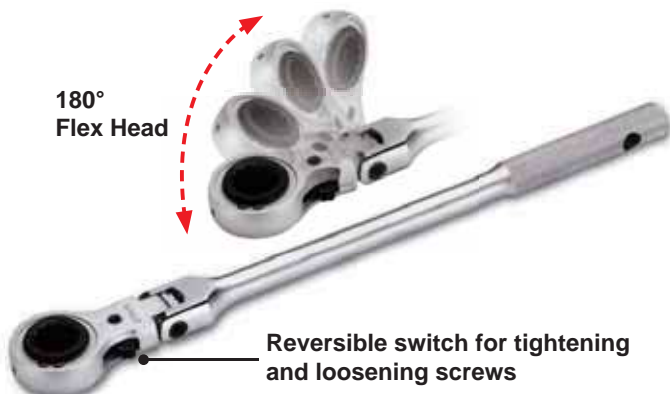

- Functions as ratchet and socket
- Reversible switch for tightening and loosening the screw
- 32-Tooth geared action
- 180° Flex head design

Model	Size	Length
<b>T29903</b>	26mm	21" 534mm
<b>T29904</b>	27mm	21" 534mm
<b>T29905</b>	28mm	21" 534mm
<b>T29906</b>	29mm	21" 534mm
<b>T29907</b>	30mm	21" 534mm
<b>T29908</b>	32mm	21" 534mm





5



### Rotator 3/8" Dr. Ratchet

- Twisting handle easily operates ratcheting function
- Excellent for tight spots where there's no room to swing the handle
- Continuous turning in one direction regardless of which way handle is turned
- Push-in drive head changes forward / reverse direction
- 60-Tooth with 6 arc swing

Model	Size	Length
<b>T29759</b>	3/8"	8-9/16" 218mm

### Lighted Ratchets



Model	Size	Length
<b>T29753</b>	1/4"	5-7/8" 145mm
<b>T29754</b>	3/8"	8" 200mm
<b>T29755</b>	1/2"	10-1/8" 255mm

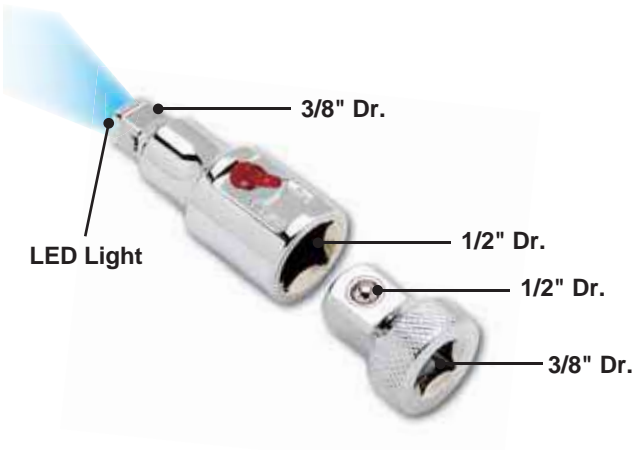

### T11391 3/8" & 1/2" Dr. Lighted Extension

- 1/2" (F) x 3/8" (M) Lighted extension with 3/8" (F) x 1/2" (M) adaptor for multiple uses
- Light shines through sockets for working in low light areas
- 3 LR44 Button cell batteries included

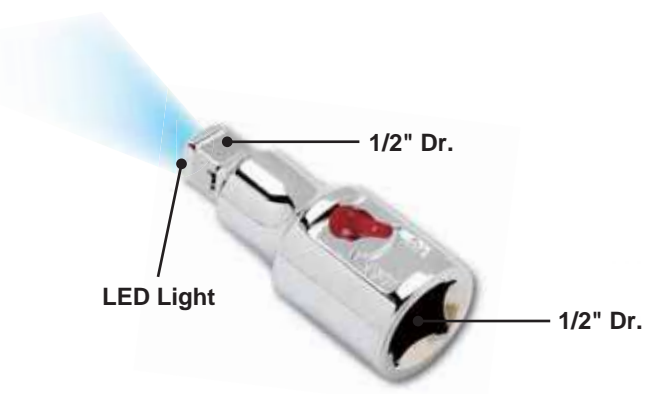

### T11390 1/2" Dr. Lighted Extension

- 1/2" (F) x 1/2" (M) Lighted extension for multiple uses
- Light shines through sockets for working in low light areas
- 3 LR44 Button cell batteries included



## Extendable Ratchets

- 72-Tooth, geared action
- Forward and reverse
- Chrome Vanadium steel



## Stubby Extendable Ratchet

- 3 Locking positions



Model	Size	Length
<b>T29763</b>	3/8"	6-1/2" (165mm) to 8-3/4" (222mm)

## Standard Extendable Ratchet

- 4 Locking positions



Model	Size	Length
<b>T29770</b>	3/8"	8-1/4" (210mm) to 12-1/4" (312mm)

## Dual-Drive Extendable Stubby Ratchets

- 3 Locking positions



Model	Size	Length
<b>T29761</b>	1/4" & 3/8"	6-1/2" (165mm) to 8-3/4" (222mm)
<b>T29762</b>	3/8" & 1/2"	6-1/2" (165mm) to 8-3/4" (222mm)

## Dual-Drive Standard Extendable Ratchet

- 4 Locking positions



Model	Size	Length
<b>T29766</b>	1/4" & 3/8"	8-1/4" (210mm) to 12-1/4" (312mm)

## Extendable Flex Ratchet

- 2 Locking positions



Model	Size	Length
<b>T29773</b>	3/8"	9-3/4" (250mm) to 13-3/4" (350mm)

## Standard Extendable Ratchet

- 6 Locking positions



Model	Size	Length
<b>T29771</b>	1/2"	12" (305mm) to 17-1/2" (450mm)

## Extendable Ratchet

- 24-Tooth, geared action
- 4 Locking positions

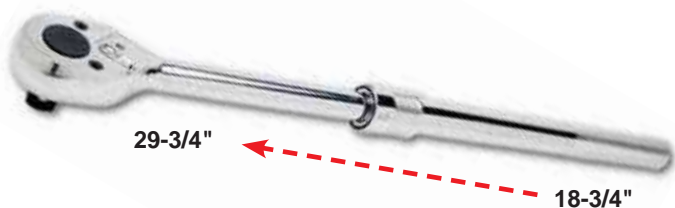

Model	Size	Length
<b>T29776</b>	3/4"	18-3/4" (475mm) to 29-3/4" (755mm)

## Extra Long Extendable Ratchet

- 4 Locking positions



Model	Size	Length
<b>T29772</b>	1/2"	18" (450mm) to 24" (610mm)



5



### T11342 4pc Lighted Extension Set

- Contents:
  - 1 - 3/8" & 1/2" Dr. Lighted Extension (T11391)
  - 3 - Extension Bar:
    - 3/8" Dr. x 3", 3/8" Dr. x 6", 1/2" Dr. x 5"



### T29796 2pc 3/8" Dr. Offset Ratchet with Disc & Lighted Extension Set

#### 3/8" Dr. Offset Ratchet with Disc

- Chrome Vanadium steel
- 72-Tooth geared ratchet
- Cushioned grip handle

#### 3/8" & 1/2" Dr. Lighted Extension

- LED light shines through sockets to work in low light areas
- Use with 3/8" or 1/2" Dr. Ratchet
- 3 LR44 button-cell batteries included



### T29797 2pc 1/2" Dr. Offset Ratchet with Disc & Lighted Extension Set

#### 1/2" Dr. Offset Ratchet with Disc

- Chrome Vanadium steel
- 72-Tooth geared ratchet
- Cushioned grip handle

#### 1/2" Dr. Lighted Extension

- 1/2" (F) x 1/2" (M) Lighted extension for multiple uses
- Light shines through sockets for working in low light areas
- 3 LR44 Button cell batteries included



Use with  
3/8" Dr. Ratchet



Use with  
1/2" Dr. Ratchet



Forward & Reverse



Quick-Release  
Button



## Industrial Style Extension Bars



- Satin Chrome Finish

Model	Size	Length
<b>T11300</b>	1/4"	2" 56mm
<b>T11301</b>	1/4"	3" 75mm
<b>T11302</b>	1/4"	6" 150mm
<b>T11303</b>	1/4"	4" 100mm
<b>T11310</b>	3/8"	3" 75mm
<b>T11313</b>	3/8"	6" 150mm
<b>T11315</b>	3/8"	10" 250mm
<b>T11320</b>	1/2"	3" 75mm
<b>T11322</b>	1/2"	5" 125mm
<b>T11324</b>	1/2"	10" 250mm
<b>T11331</b>	3/4"	4" 100mm
<b>T11332</b>	3/4"	8" 200mm
<b>T11334</b>	3/4"	16" 400mm
<b>T11336</b>	1"	8" 200mm
<b>T11338</b>	1"	16" 400mm

## Extension Bars



- Mirror Chrome Finish

Model	Size	Length
<b>T11400</b>	1/4"	2" 50mm
<b>T11401</b>	1/4"	3" 75mm
<b>T11402</b>	1/4"	6" 150mm
<b>T11403</b>	1/4"	4" 100mm
<b>T11415</b>	3/8"	3" 75mm
<b>T11416</b>	3/8"	6" 150mm
<b>T11418</b>	3/8"	10" 250mm
<b>T11424</b>	1/2"	3" 75mm
<b>T11425</b>	1/2"	5" 125mm
<b>T11426</b>	1/2"	10" 250mm

## Extension Bars with Magnet

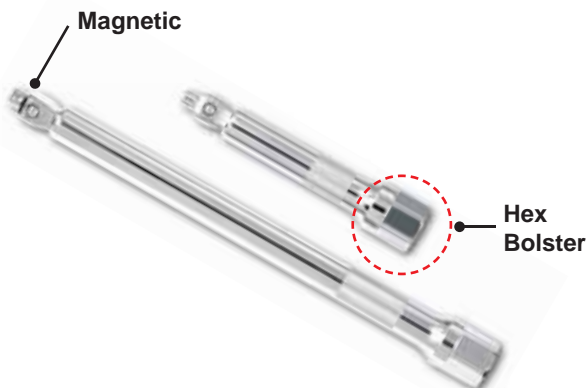

Model	Size	Length
<b>T11354</b>	3/8"	6" 150mm
<b>T11355</b>	3/8"	10" 250mm
<b>T11357</b>	1/2"	5" 125mm
<b>T11358</b>	1/2"	10" 250mm



## 2-Way Wobble Extensions

- 2-in-1 Action, Wobble & Standard
- Non-Slip Knurled Shaft



Wobble Action



Push to Lock in Standard Position

**T11347 4pc 1/4", 3/8" & 1/2" Dr. 2-Way Wobble Extension Set**

1/4" Dr. x 4" (100mm), 3/8" Dr. x 3" (75mm), 3/8" Dr. x 6" (150mm), 1/2" Dr. x 5" (125mm)

**T11351 3pc 3/8" Dr. 2-Way Wobble Extension Set**

3" (75mm), 6" (150mm) and 8" (200mm)

**T11352 3pc 1/2" Dr. 2-Way Wobble Extension Set**

3" (75mm), 5" (125mm) and 10" (250mm)

**T11345 3pc 3/8" Dr. 2-Way Wobble Extension Set**

1-3/4" (45mm), 3" (75mm) and 6" (150mm)

**T11346 3pc 1/2" Dr. 2-Way Wobble Extension Set**

2" (50mm), 5" (125mm) and 10" (250mm)

## Industrial Wobble Extension Sets



**T11348 3pc 1/4" Dr. Wobble Extension Set**

3" (75mm), 4" (100mm) and 6" (150mm)

**T11349 3pc 3/8" Dr. Wobble Extension Set**

3" (75mm), 6" (150mm) and 8" (200mm)

**T11350 3pc 1/2" Dr. Wobble Extension Set**

3" (75mm), 5" (125mm) and 10" (250mm)



Industrial Style

## Quick-Release Extension Bars



Model	Size	Length
T11363	3/8"	3" 75mm
T11364	3/8"	6" 150mm
T11365	3/8"	10" 250mm
T11367	1/2"	5" 125mm
T11368	1/2"	10" 250mm

## Quick-Release Extensions

### T11366 3pc 1/4", 3/8", 1/2" Dr. Quick-Release Extension Set

1/4" Dr. x 6" (150mm), 3/8" Dr. x 10" (250mm),  
1/2" Dr. x 10" (250mm)

### T11369 4pc 1/4", 3/8", 1/2" Dr. Quick-Release Extension Set

1/4" Dr. x 4" (100mm), 3/8" Dr. x 3" (75mm),  
3/8" Dr. x 6" (150mm), 1/2" Dr. x 5" (125mm)



Non-Slip  
Knurled Shaft

Non-Slip  
Knurled Shaft

Quick-Release  
Push Button



## Extra Long Extension Sets

### T11328 1/2" Dr. x 20" (500mm) Extension Bar

### T11340 3pc 1/4" Dr. Extension Bar Set 9" (230mm), 10" (250mm), 14" (355mm)

### T11341 2pc 3/8" Dr. Extra Long Extension Set 18" (450mm), 24" (610mm)







5

### Foldable Extension T-Handles

- Quick-release shaft

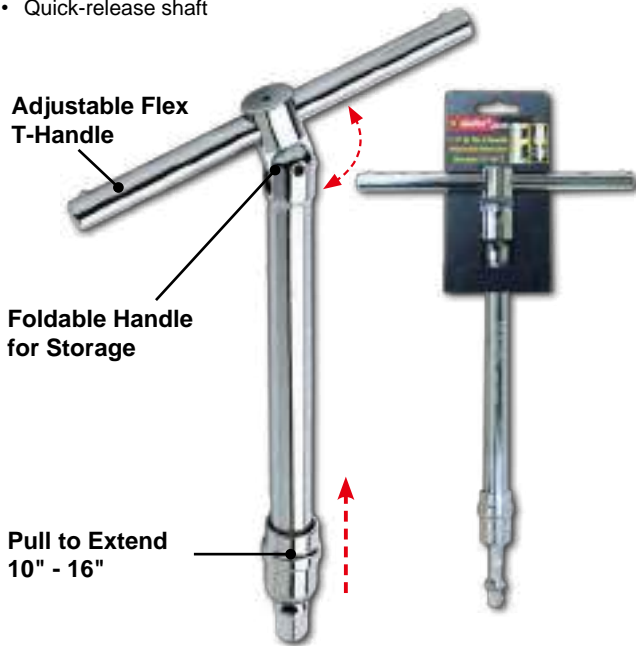

Model	Size	Length
T20753	3/8"	10" (250mm) to 16" (405mm)
T20754	1/2"	10" (250mm) to 16" (405mm)

### T-Handle Socket Wrenches (6pt)

- Chrome Vanadium nut driver
- Sliding T-handle to reach confined areas



Model	Size
T41708	8mm
T41709	9mm
T41710	10mm
T41711	11mm
T41712	12mm
T41713	13mm
T41714	14mm

### Foldable Extension T-Handles w/ Flex Socket Adaptor

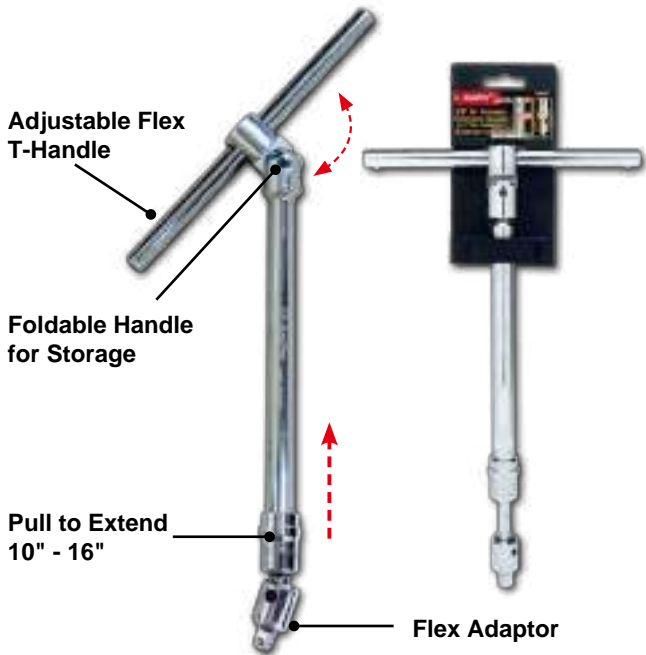

Model	Size	Length
T20752	3/8"	10" (250mm) to 16" (405mm)

### Adjustable Extension Bars

- Quick-release shaft design
- Six locking positions in 1" increments
- Excellent for confined areas

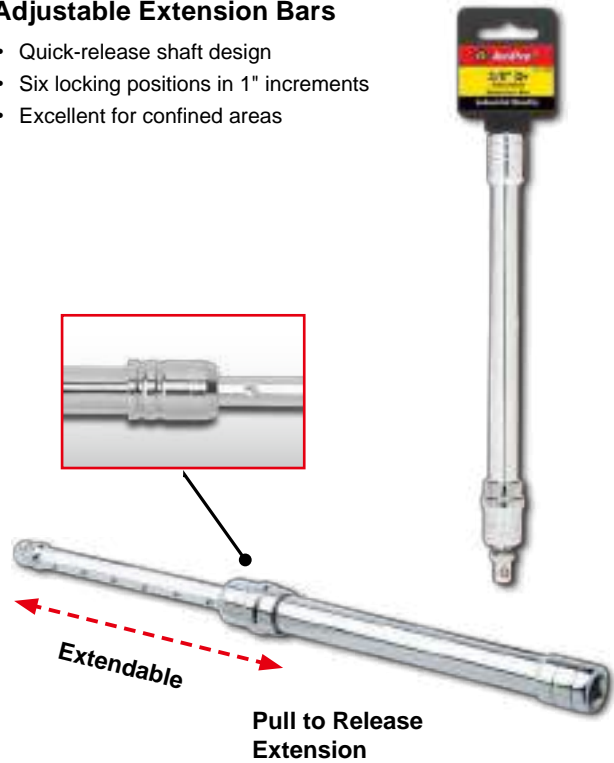

Model	Size	Length
T11370	3/8"	10" (250mm) to 16" (405mm)
T11375	1/2"	10" (250mm) to 16" (405mm)



### T-Handle Spark Plug Sockets with Magnet



Model	Size	Length
T33348	16mm	15" 375mm
T33349	21mm	15" 375mm

### T41700 3-in-1 T-Handle Socket Wrench (6pt)

- Chrome Vanadium steel
- T-handle to reach confined areas
- Contents: 8, 10, 12mm



### Sliding T-Handles



Model	Size	Length
T20741	1/4"	4-1/2" 115mm
T20742	3/8"	8" 200mm
T20744	1/2"	10" 250mm
T20745	1/2"	12" 300mm
T20747	3/4"	18" 450mm
T20748	3/4"	20" 500mm
T20749	1"	22" 560mm

### Quick-Release Sliding T-Handles



Model	Size	Length
T20760	3/8"	8" 200mm
T20761	1/2"	10" 250mm
T20762	3/4"	18" 450mm
T20763	1"	22" 550mm

### Flex Handles (Satin Finish)

- Chrome Vanadium steel, satin finish
- Hardened, tempered and chrome plated
- Spring loaded ball bearing construction



Mode	Size	Length
T20700	1/4"	5-1/2" 140mm
T20705	3/8"	8" 200mm
T20706	3/8"	10" 250mm
T20714	1/2"	15" 380mm
T20716	1/2"	18" 450mm
T20732	3/4"	19" 475mm
T20736	1"	26" 650mm

### Flex Handles (Mirror Finish)

- Chrome Vanadium steel, mirror finish
- Hardened, tempered and chrome plated
- Spring loaded ball bearing construction



Mode	Size	Length
T20701	1/4"	5-1/2" 140mm
T20704	3/8"	8" 200mm
T20707	3/8"	10" 250mm
T20711	1/2"	10" 250mm
T20713	1/2"	15" 380mm
T20717	1/2"	18" 450mm



5

### Flex Handle with Quick Release



Model	Size	Length
T20721	3/4"	21" 530mm

### Flex Handle with Quick Release Telescope



Model	Size	Length
T20722	3/4"	20" (500mm) to 32" (800mm)

### 1/2" Dr. x 24" Heavy Duty Breaker Bar

- Heavy duty construction for professional use
- Chrome Molybdenum steel head for performance and durability



Model	Size	Length
T20727	1/2"	24" 610mm

### 1/2" Dr. Adjustable Breaker Bar

- 180-Degree swivel head
- Chrome Vanadium steel
- Cushioned grip handle
- 4 Locking positions



Model	Size	Length
T20729	1/2"	18" (450mm) to 24" (610mm)

### 1/2" Dr. x 24" (610mm) Ratcheting Breaker Bar

- Chrome Vanadium steel
- 3 Steps - forward, fixed and reverse lever
- 180-Degree swivel head
- Ratcheting lock feature functions as a breaker bar



Swivel Ratcheting Head



Model	Size	Length
T20730	1/2"	24" 610mm



## Universal Joints

- Adds flexibility to use sockets at various angles
- 90° Swivel Head



**A**  
Satin Chrome Finish

**B**  
Mirror Chrome Finish

	Model	Size	Length
A	T33300	1/4"	40mm
	T33302	3/8"	55mm
	T33304	1/2"	78mm
	T33306	3/4"	109mm
	T33308	1"	140mm
B	T33301	1/4"	40mm
	T33303	3/8"	55mm
	T33305	1/2"	78mm

## Spark Plug Sockets



Model	Size	Length
T33320	3/8" Dr. x 16mm	65mm
T33322	3/8" Dr. x 21mm	65mm
T33323	1/2" Dr. x 16mm	65mm
T33325	1/2" Dr. x 21mm	65mm
T33340	3/8" Dr. x 5/8"	65mm
T33341	3/8" Dr. x 13/16"	65mm
T33342	1/2" Dr. x 5/8"	65mm
T33343	1/2" Dr. x 13/16"	65mm

## Spark Plug Sockets w/ Magnet



Model	Size	Length
T33390	3/8" Dr. x 16mm	67mm
T33391	3/8" Dr. x 21mm	67mm
T33392	1/2" Dr. x 16mm	67mm
T33393	1/2" Dr. x 21mm	67mm
T33394	3/8" Dr. x 5/8"	67mm
T33395	3/8" Dr. x 13/16"	67mm
T33396	1/2" Dr. x 5/8"	67mm
T33397	1/2" Dr. x 13/16"	67mm

## T33650 3pc Universal Joint Set

- Chrome Vanadium steel
- Sizes: 1/4", 3/8" & 1/2" Dr.

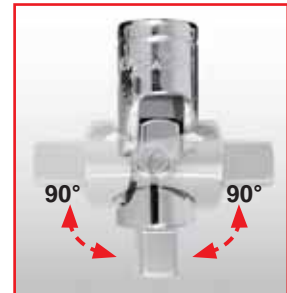

## T33327 2pc 3/8" Dr. Spark Plug Sockets

- Sizes: 5/8", 13/16"

## T33326 5pc 3/8" Dr. Spark Plug Socket Set

- Sizes: 5/8", 3/4", 13/16", 14mm, 18mm



## Extended Flex Spark Plug Sockets w/ Magnet



Model	Size	Length
T33336	3/8" Dr. x 16mm	13-1/2" 342mm
T33337	3/8" Dr. x 21mm	13-1/2" 342mm
T33338	3/8" Dr. x 5/8"	13-1/2" 342mm
T33339	3/8" Dr. x 13/16"	13-1/2" 342mm
T33344	1/2" Dr. x 16mm	16" 400mm
T33345	1/2" Dr. x 21mm	16" 400mm

5

### T33335 4pc Socket Adaptor Set



- Sizes:  
 3/8" (F) x 1/4" (M),  
 1/2" (F) x 3/8" (M),  
 3/8" (F) x 1/2" (M),  
 1/4" (F) x 3/8" (M)

### Socket Adaptors

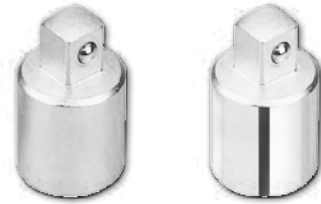

**A** Satin Chrome      **B** Mirror Chrome

	Model	Size	Length
<b>A</b>	T33312	3/8" F x 1/4" M	27mm
	T33313	3/8" F x 1/2" M	35mm
	T33314	1/2" F x 3/8" M	34mm
	T33315	1/2" F x 3/4" M	50mm
	T33316	3/4" F x 1/2" M	54mm
	T33317	3/4" F x 1" M	62mm
	T33318	1" F x 3/4" M	70mm
	T33319	1/4" F x 3/8" M	25mm
	<b>B</b>	T33331	1/4" F x 3/8" M
T33332		3/8" F x 1/4" M	27mm
T33333		3/8" F x 1/2" M	35mm
T33334		1/2" F x 3/8" M	34mm

### T32581 1/4" Dr. x 6" (150mm) Spinner Handle

- Quickly tightens and loosens fasteners
- Features 1/4" Dr. "F" square drive at end of handle



### L-Handles



Model	Size	Length
T11441	1/2"	10" 250mm
T11443	3/4"	24" 600mm
T11445	1"	26" 650mm

### T11385 1/4" Dr. Adjustable Socket & Bit Driver

- Quick-release extension bar
- Chrome vanadium steel
- Ribbed, cushioned grip handle
- Easily accesses hard-to-reach areas
- Extends 7-1/2" to 12-1/2"



\* Bit not included

### Speeder Handles



Model	Size	Length
T20718	3/8"	15" 380mm
T20719	1/2"	15" 380mm



1/4" Dr. End Cap for Extra Torque and Strength



2-Way Wobble Action Driver

Use As Wobble or Standard





# Sockets & Sockets Sets

Regular Sockets

Deep Sockets

External Sockets





## 1/4" Dr. SAE / Metric Sockets (Chrome Vanadium Steel, Convex Drive, 6PT)

**6**

SAE - 6PT			Metric - 6PT		
Regular	Deep	Size	Regular	Deep	Size
T334000	T334100	5/32"	T335001	T335101	4mm
T334001		3/16"	T335002	T335102	4.5mm
T334002	T334102	7/32"	T335003	T335103	5mm
T334003	T334103	1/4"	T335004	T335104	5.5mm
T334004	T334104	9/32"	T335005	T335105	6mm
T334005	T334105	5/16"	T335007	T335107	7mm
T334006	T334106	11/32"	T335008	T335108	8mm
T334007	T334107	3/8"	T335009	T335109	9mm
T334009	T334109	7/16"	T335010	T335110	10mm
T334011	T334111	1/2"	T335011	T335111	11mm
T334013		9/16"	T335012	T335112	12mm
			T335013	T335113	13mm
			T335014	T335114	14mm

## 3/8" Dr. SAE / Metric Sockets (Chrome Vanadium Steel, Convex Drive, 6PT)



SAE - 6PT			Metric - 6PT		
Regular	Deep	Size	Regular	Deep	Size
T334201	T334301	1/4"	T335206	T335306	6mm
T334202	T334302	5/16"	T335207	T335307	7mm
	T334303	11/32"	T335208	T335308	8mm
T334204	T334304	3/8"	T335209	T335309	9mm
T334205	T334305	7/16"	T335210	T335310	10mm
T334206	T334306	1/2"	T335211	T335311	11mm
T334207	T334307	9/16"	T335212	T335312	12mm
	T334308	19/32"	T335213	T335313	13mm
T334209	T334309	5/8"	T335214	T335314	14mm
T334210	T334310	11/16"	T335215	T335315	15mm
T334211	T334311	3/4"	T335216	T335316	16mm
T334213	T334313	13/16"	T335217	T335317	17mm
T334214	T334314	7/8"	T335218	T335318	18mm
			T335219	T335319	19mm
			T335220	T335320	20mm
			T335221	T335321	21mm
			T335222	T335322	22mm

## 3/8" Dr. SAE / Metric Sockets (Chrome Vanadium Steel, Convex Drive, 12PT)



SAE - 12PT			Metric - 12PT		
Regular	Deep	Size	Regular	Deep	Size
T334251	T334351	1/4"	T335256	T335356	6mm
T334252	T334352	5/16"	T335257	T335357	7mm
T334254	T334354	3/8"	T335258	T335358	8mm
T334255	T334355	7/16"	T335259	T335359	9mm
T334256	T334356	1/2"	T335260	T335360	10mm
T334257	T334357	9/16"	T335261	T335361	11mm
T334259	T334359	5/8"	T335262	T335362	12mm
T334260	T334360	11/16"	T335263	T335363	13mm
T334261	T334361	3/4"	T335264	T335364	14mm
	T334362	25/32"	T335265	T335365	15mm
T334263	T334363	13/16"	T335266	T335366	16mm
T334264		7/8"	T335267	T335367	17mm
			T335268	T335368	18mm
			T335269	T335369	19mm
			T335270	T335370	20mm
			T335271	T335371	21mm
			T335272	T335372	22mm

## 1/2" Dr. SAE / Metric Sockets (Chrome Vanadium Steel, Convex Drive, 6PT)



SAE - 6PT			Metric - 6PT		
Regular	Deep	Size	Regular	Deep	Size
T334400	T334500	5/16"	T335408	T335508	8mm
T334401	T334501	3/8"	T335409	T335509	9mm
T334402	T334502	7/16"	T335410	T335510	10mm
T334403	T334503	15/32"	T335411	T335511	11mm
T334404	T334504	1/2"	T335412	T335512	12mm
T334405	T334505	9/16"	T335413	T335513	13mm
T334406		19/32"	T335414	T335514	14mm
T334407	T334507	5/8"	T335415	T335515	15mm
T334409	T334509	11/16"	T335416	T335516	16mm
T334410	T334510	3/4"	T335417	T335517	17mm
T334411		25/32"	T335418	T335518	18mm

**6**

SAE - 6PT			Metric - 6PT		
Regular	Deep	Size	Regular	Deep	Size
T334412	T334512	13/16"	T335419	T335519	19mm
T334413	T334513	7/8"	T335420	T335520	20mm
T334414	T334514	15/16"	T335421	T335521	21mm
T334416	T334516	1"	T335422	T335522	22mm
T334417	T334517	1-1/16"	T335423	T335523	23mm
T334418	T334518	1-1/8"	T335424	T335524	24mm
T334419	T334519	1-3/16"	T335425	T335525	25mm
T334420	T334520	1-1/4"	T335426	T335526	26mm
	T334522	1-1/2"	T335427	T335527	27mm
			T335428	T335528	28mm
			T335429		29mm
			T335430	T335530	30mm
			T335432	T335532	32mm
			T335436		36mm

### 1/2" Dr. SAE / Metric Sockets (Chrome Vanadium Steel, Convex Drive, 12PT)



SAE - 12PT			Metric - 12PT		
Regular	Deep	Size	Regular	Deep	Size
T334450	T334550	5/16"	T335458	T335558	8mm
T334451	T334551	3/8"	T335459	T335559	9mm
T334452	T334552	7/16"	T335460	T335560	10mm
T334454	T334554	1/2"	T335461	T335561	11mm
T334455	T334555	9/16"	T335462	T335562	12mm
T334457	T334557	5/8"	T335463	T335563	13mm
T334459	T334559	11/16"	T335464	T335564	14mm
T334460	T334560	3/4"	T335465	T335565	15mm
T334462	T334562	13/16"	T335466	T335566	16mm
T334463	T334563	7/8"	T335467	T335567	17mm
T334464	T334564	15/16"	T335468	T335568	18mm
T334466	T334566	1"	T335469	T335569	19mm
T334467	T334567	1-1/16"	T335470	T335570	20mm
T334468	T334568	1-1/8"	T335471	T335571	21mm
T334469	T334569	1-3/16"	T335472	T335572	22mm
T334470	T334570	1-1/4"	T335473	T335573	23mm
			T335474	T335574	24mm
			T335475		25mm
			T335476		26mm
			T335477	T335577	27mm
			T335478		28mm
			T335479		29mm
			T335480	T335580	30mm
			T335482	T335582	32mm



## 3/4" Dr. SAE / Metric Sockets (Chrome Vanadium Steel, Convex Drive, 6PT & 12PT)



6

SAE - 12PT			Metric - 6PT			Metric - 12PT		
Regular	Size	Point	Regular	Size	Point	Regular	Size	Point
T334652	3/4"	12pt	T335601	17mm	6pt	T335651	17mm	12pt
T334654	13/16"	12pt	T335602	18mm	6pt	T335652	18mm	12pt
T334655	7/8"	12pt	T335603	19mm	6pt	T335653	19mm	12pt
T334656	15/16"	12pt	T335604	20mm	6pt	T335654	20mm	12pt
T334657	1"	12pt	T335605	21mm	6pt	T335655	21mm	12pt
T334658	1-1/16"	12pt	T335606	22mm	6pt	T335656	22mm	12pt
T334659	1-1/8"	12pt	T335607	23mm	6pt	T335657	23mm	12pt
T334660	1-3/16"	12pt	T335608	24mm	6pt	T335658	24mm	12pt
T334661	1-1/4"	12pt	T335609	25mm	6pt	T335659	25mm	12pt
T334662	1-5/16"	12pt	T335610	26mm	6pt	T335660	26mm	12pt
T334663	1-3/8"	12pt	T335611	27mm	6pt	T335661	27mm	12pt
T334664	1-7/16"	12pt	T335612	28mm	6pt	T335662	28mm	12pt
T334665	1-1/2"	12pt	T335613	29mm	6pt	T335663	29mm	12pt
T334666	1-9/16"	12pt	T335614	30mm	6pt	T335664	30mm	12pt
T334667	1-5/8"	12pt	T335615	31mm	6pt	T335666	32mm	12pt
T334668	1-11/16"	12pt	T335616	32mm	6pt	T335667	33mm	12pt
T334669	1-3/4"	12pt	T335617	33mm	6pt	T335668	34mm	12pt
T334670	1-13/16"	12pt	T335618	34mm	6pt	T335669	35mm	12pt
T334671	1-7/8"	12pt	T335619	35mm	6pt	T335670	36mm	12pt
T334672	1-15/16"	12pt	T335620	36mm	6pt	T335671	38mm	12pt
T334673	2"	12pt	T335621	38mm	6pt	T335672	40mm	12pt
T334674	2-1/16"	12pt	T335622	40mm	6pt	T335673	41mm	12pt
T334675	2-1/8"	12pt	T335623	41mm	6pt	T335674	42mm	12pt
T334676	2-3/16"	12pt	T335624	42mm	6pt	T335676	44mm	12pt
T334677	2-1/4"	12pt	T335628	46mm	6pt	T335678	46mm	12pt
T334678	2-5/16"	12pt	T335629	48mm	6pt	T335679	48mm	12pt
T334679	2-3/8"	12pt	T335630	50mm	6pt	T335680	50mm	12pt
T334680	2-7/16"	12pt	T335633	54mm	6pt	T335683	54mm	12pt
T334681	2-1/2"	12pt	T335634	55mm	6pt	T335684	55mm	12pt
			T335636	58mm	6pt	T335685	56mm	12pt
			T335638	60mm	6pt	T335688	60mm	12pt
			T335640	65mm	6pt	T335690	65mm	12pt
			T335641	70mm	6pt	T335691	70mm	12pt

## 1" Dr. SAE / Metric Sockets (Chrome Vanadium Steel, Convex Drive, 6PT & 12PT)



6

SAE - 12PT			Metric - 6PT			Metric - 12PT		
Regular	Size	Point	Regular	Size	Point	Regular	Size	Point
T334860	1-3/8"	12pt	T335702	36mm	6pt	T335764	35mm	12pt
T334861	1-7/16"	12pt	T335703	38mm	6pt	T335765	36mm	12pt
T334862	1-1/2"	12pt	T335704	41mm	6pt	T335766	38mm	12pt
T334864	1-5/8"	12pt	T335705	46mm	6pt	T335768	41mm	12pt
T334865	1-11/16"	12pt	T335706	50mm	6pt	T335771	46mm	12pt
T334866	1-3/4"	12pt	T335707	54mm	6pt	T335773	50mm	12pt
T334867	1-13/16"	12pt	T335708	55mm	6pt	T335776	54mm	12pt
T334868	1-7/8"	12pt	T335709	58mm	6pt	T335777	55mm	12pt
T334870	2"	12pt	T335710	60mm	6pt	T335779	58mm	12pt
T334871	2-1/16"	12pt	T335711	63mm	6pt	T335781	60mm	12pt
T334872	2-1/8"	12pt	T335712	65mm	6pt	T335782	63mm	12pt
T334873	2-3/16"	12pt	T335713	67mm	6pt	T335783	65mm	12pt
T334874	2-1/4"	12pt	T335714	70mm	6pt	T335784	67mm	12pt
T334875	2-5/16"	12pt	T335715	71mm	6pt	T335786	70mm	12pt
T334876	2-3/8"	12pt	T335716	75mm	6pt	T335787	71mm	12pt
T334877	2-7/16"	12pt	T335717	77mm	6pt	T335788	75mm	12pt
T334878	2-1/2"	12pt	T335718	80mm	6pt	T335789	77mm	12pt
T334879	2-9/16"	12pt				T335790	80mm	12pt
T334880	2-5/8"	12pt						
T334882	2-3/4"	12pt						
T334883	2-13/16"	12pt						
T334885	2-15/16"	12pt						
T334886	3"	12pt						
T334887	3-1/8"	12pt						



## External Star Sockets

- Permanent high-contrast marking resists chipping and fading. Excellent for use in low-lit and oily environments



## 1/4" Dr. External Star Sockets (Full Polish)



Model	Size
<b>T33350</b>	E4
<b>T33351</b>	E5
<b>T33352</b>	E6
<b>T33353</b>	E7
<b>T33354</b>	E8
<b>T33355</b>	E10
<b>T33356</b>	E11

6

## 1/4" Dr. Deep External Star Sockets (Full Polish)



Model	Size
<b>T33380</b>	E4
<b>T33381</b>	E5
<b>T33382</b>	E6
<b>T33383</b>	E7
<b>T33384</b>	E8

## 3/8" Dr. External Star Sockets (Full Polish)



Model	Size
<b>T33280</b>	E8
<b>T33281</b>	E10
<b>T33282</b>	E12
<b>T33283</b>	E14
<b>T33284</b>	E16

## 3/8" Dr. External Star Sockets



Model	Size
<b>T33358</b>	E5
<b>T33359</b>	E6
<b>T33360</b>	E7
<b>T33361</b>	E8
<b>T33362</b>	E10
<b>T33363</b>	E11
<b>T33364</b>	E12
<b>T33365</b>	E14
<b>T33366</b>	E16
<b>T33367</b>	E18
<b>T33368</b>	E20

## 1/2" Dr. External Star Sockets



Model	Size
<b>T33370</b>	E10
<b>T33371</b>	E11
<b>T33372</b>	E12
<b>T33373</b>	E14
<b>T33374</b>	E16
<b>T33375</b>	E18
<b>T33376</b>	E20
<b>T33377</b>	E22
<b>T33378</b>	E24





## "Star" Bit Sockets

- S2 Alloy steel bit



37mm	55mm	100mm	
T33660			1/4" Dr. x T8
T33661			1/4" Dr. x T10
T33662			1/4" Dr. x T15
T33663			1/4" Dr. x T20
T33664			1/4" Dr. x T25
T33665			1/4" Dr. x T27
T33666			1/4" Dr. x T30
T33667			1/4" Dr. x T40
	T33006	T33106	1/2" Dr. x T20
	T33007	T33107	1/2" Dr. x T25
	T33008	T33108	1/2" Dr. x T27
	T33009	T33109	1/2" Dr. x T30
	T33010	T33110	1/2" Dr. x T40
	T33011	T33111	1/2" Dr. x T45
	T33012	T33112	1/2" Dr. x T47
	T33013	T33113	1/2" Dr. x T50
	T33014	T33114	1/2" Dr. x T55
	T33015	T33115	1/2" Dr. x T60
	T33016	T33116	1/2" Dr. x T70

## "Tamper-Proof Star" Bit Sockets

- S2 Alloy steel bit



37mm	55mm	100mm	
T33670			1/4" Dr. x T8
T33671			1/4" Dr. x T10
T33672			1/4" Dr. x T15
T33673			1/4" Dr. x T20
T33674			1/4" Dr. x T25
T33675			1/4" Dr. x T27
T33676			1/4" Dr. x T30
T33677			1/4" Dr. x T40
	T33026	T33126	1/2" Dr. x T20
	T33027	T33127	1/2" Dr. x T25
	T33028	T33128	1/2" Dr. x T27
	T33029	T33129	1/2" Dr. x T30
	T33030	T33130	1/2" Dr. x T40
	T33031	T33131	1/2" Dr. x T45
	T33032	T33132	1/2" Dr. x T47
	T33033	T33133	1/2" Dr. x T50
	T33034	T33134	1/2" Dr. x T55
	T33035	T33135	1/2" Dr. x T60
	T33036	T33136	1/2" Dr. x T70

## "Hex" Bit Sockets

- S2 Alloy steel bit



55mm	SAE
T33090	1/2" Dr. x 3/16"
T33091	1/2" Dr. x 7/32"
T33092	1/2" Dr. x 1/4"
T33093	1/2" Dr. x 5/16"
T33094	1/2" Dr. x 3/8"
T33095	1/2" Dr. x 7/16"
T33096	1/2" Dr. x 1/2"
T33097	1/2" Dr. x 9/16"
T33098	1/2" Dr. x 5/8"
T33099	1/2" Dr. x 3/4"

55mm	100mm	Metric
T33043	T33143	1/2" Dr. x 3mm
T33044	T33144	1/2" Dr. x 4mm
T33045	T33145	1/2" Dr. x 5mm
T33046	T33146	1/2" Dr. x 6mm
T33047	T33147	1/2" Dr. x 7mm
T33048	T33148	1/2" Dr. x 8mm
T33049	T33149	1/2" Dr. x 9mm
T33050	T33150	1/2" Dr. x 10mm
T33051		1/2" Dr. x 11mm
T33052	T33152	1/2" Dr. x 12mm
T33054	T33154	1/2" Dr. x 14mm
T33055		1/2" Dr. x 15mm
T33056		1/2" Dr. x 16mm
T33057	T33157	1/2" Dr. x 17mm
T33058		1/2" Dr. x 18mm
T33059	T33159	1/2" Dr. x 19mm

## "Tamper-Proof Hex" Bit Sockets

- S2 Alloy steel bit



55mm	100mm	
<b>T33063</b>	<b>T33163</b>	1/2" Dr. x 3mm
<b>T33064</b>	<b>T33164</b>	1/2" Dr. x 4mm
<b>T33065</b>	<b>T33165</b>	1/2" Dr. x 5mm
<b>T33066</b>	<b>T33166</b>	1/2" Dr. x 6mm
<b>T33067</b>	<b>T33167</b>	1/2" Dr. x 7mm
<b>T33068</b>	<b>T33168</b>	1/2" Dr. x 8mm
<b>T33070</b>	<b>T33170</b>	1/2" Dr. x 10mm
<b>T33072</b>	<b>T33172</b>	1/2" Dr. x 12mm
<b>T33074</b>	<b>T33174</b>	1/2" Dr. x 14mm
<b>T33077</b>	<b>T33177</b>	1/2" Dr. x 17mm
<b>T33079</b>	<b>T33179</b>	1/2" Dr. x 19mm

## "Spline" Bit Sockets

- S2 Alloy steel bit



55mm	100mm	
<b>T33080</b>	<b>T33180</b>	1/2" Dr. x M5
<b>T33081</b>	<b>T33181</b>	1/2" Dr. x M6
<b>T33082</b>	<b>T33182</b>	1/2" Dr. x M8
<b>T33083</b>	<b>T33183</b>	1/2" Dr. x M10
<b>T33084</b>	<b>T33184</b>	1/2" Dr. x M12
<b>T33085</b>	<b>T33185</b>	1/2" Dr. x M14
<b>T33086</b>	<b>T33186</b>	1/2" Dr. x M16

## "Star" Bit Sockets (Mirror Finish)

- S2 Alloy steel bit



48mm	55mm	
<b>T33636</b>		3/8" Dr. x T30
<b>T33637</b>		3/8" Dr. x T40
<b>T33638</b>		3/8" Dr. x T45
<b>T33639</b>		3/8" Dr. x T47
<b>T33640</b>		3/8" Dr. x T50
<b>T33641</b>		3/8" Dr. x T55
	<b>T33645</b>	1/2" Dr. x T60

## "Hex" Bit Sockets (Mirror Finish)

- S2 Alloy steel bit



48mm	
<b>T33606</b>	3/8" Dr. x 6mm
<b>T33607</b>	3/8" Dr. x 7mm
<b>T33608</b>	3/8" Dr. x 8mm
<b>T33610</b>	3/8" Dr. x 10mm
<b>T33617</b>	3/8" Dr. x 3/16"
<b>T33619</b>	3/8" Dr. x 1/4"
<b>T33620</b>	3/8" Dr. x 5/16"
<b>T33621</b>	3/8" Dr. x 3/8"



### T33212 6pc Spline Bit Set

- Contents: (S2 Alloy steel)
  - 5 - 3/8" (10mm) Spline Bits: M5, M6, M8, M10, M12 (30mm)
  - 1 - 1/2" Dr. x 10mm Bit Holder

### T33210 7pc Star Bit Set

- Contents: (S2 Alloy steel)
  - 6 - 3/8" (10mm) Star Bits: T20, T25, T30, T40, T45, T50 (30mm)
  - 1 - 1/2" Dr. x 10mm Bit Holder

### T33211 7pc Hex Bit Set

- Contents: (S2 Alloy steel)
  - 6 - 3/8" (10mm) Hex Bits: 4, 5, 6, 7, 8, 10mm (30mm)
  - 1 - 1/2" Dr. x 10mm Bit Holder



## (A) External Star Socket Sets

### T33202 7pc External Star Socket Set

1/4" Dr. - E6, E7, E8  
3/8" Dr. - E10, E12, E14, E16

### T33204 9pc External Star Socket Set

3/8" (F) to 1/4" (M) Adaptor  
1/4" Dr. - E5, E6, E7, E8  
3/8" Dr. - E10, E12, E14, E16

### T33209 9pc 1/2" Dr. External Star Socket Set

E10, E11, E12, E14, E16, E18, E20, E22, E24

### T33201 4pc 3/8" Dr. External Star Socket Set

E8, E10, E12, E14



(A)



(B)

## (B) Bit Socket Sets

### T33240 5pc 3/8" Dr. Star Bit Socket Set

T40, T45, T47, T50, T55

### T33241 10pc 1/4" & 3/8" Dr. Star Bit Socket Set

1/4" Dr. - T10, T15, T20, T25  
3/8" Dr. - T27, T30, T40, T45, T50, T55

### T33205 10pc 3/8" Dr. Hex Bit Socket Set

2, 3, 4, 5, 5.5, 6, 7, 8, 9, 10mm

### T33206 10pc 3/8" Dr. Hex Bit Socket Set

3/32", 7/64", 1/8", 9/64", 5/32", 3/16", 7/32", 1/4", 5/16", 3/8"

### T33208 8pc 3/8" Dr. Hex Bit Socket Set

5/32", 3/16", 7/32", 1/4", 5/16", 3/8", 1/2", 9/16"

### T33221 12pc Star Bit Socket Set

1/4" Dr. - T10, T15, T20, T25, T27, T30  
3/8" Dr. - T40, T45, T47, T50, T55  
1/2" Dr. - T60

### T33207 8pc 1/2" Dr. Hex Bit Socket Set

5, 6, 8, 10, 12, 14, 17, 19mm

### T33222 8pc 1/2" Dr. Star Bit Socket Set

T20, T25, T27, T30, T40, T45, T50, T55

### T33220 9pc Tamper-Proof Star Bit Socket Set

1/4" Dr. - T10, T15, T20, T25, T27, T30  
3/8" Dr. - T40, T45, T50

### T33230 4pc 1/2" Dr. Spline Bit Socket Set

M6, M8, M10, M12

## Long Bit Socket Sets

### T33215 5pc 1/2" Dr. Long Hex Bit Socket Set

6, 7, 8, 10, 12mm (100mm)

### T33223 4pc 1/2" Dr. Long Star Bit Socket Set

T40, T45, T50, T55 (100mm)

### T33231 4pc 1/2" Dr. Long Spline Bit Socket Set

M6, M8, M10, M12 (100mm)



### T33242 16pc Industrial Star Bit Set

- Contents: (S2 Alloy Steel)  
T10, T15, T20, T25, T27, T30 (30mm)  
T20, T25, T30, T40, T45, T47, T50, T55, T60 (75mm)  
3/8" Dr. Adaptor





**Socket Sets with Socket Rail**

**T45401 12pc 1/2" Dr. 6pt Socket Set**  
10, 12, 13, 14, 15, 16, 17, 18, 19, 21, 22, 24mm

**T45409 18pc 1/2" Dr. 6pt Socket Set**  
10, 11, 12, 13, 14, 15, 16, 17, 18, 19, 20, 21, 22, 23, 24, 27, 30, 32mm

**T45405 22pc 1/2" Dr. 6pt Socket Set**  
10, 11, 12, 13, 14, 15, 16, 17, 18, 19, 20, 21, 22, 23, 24, 25, 26, 27, 28, 29, 30, 32mm

**T45433 12pc 1/2" Dr. 12pt Socket Set**  
10, 12, 13, 14, 15, 16, 17, 18, 19, 21, 22, 24mm

**T45404 18pc 1/2" Dr. 12pt Socket Set**  
10, 11, 12, 13, 14, 15, 16, 17, 18, 19, 20, 21, 22, 23, 24, 27, 30, 32mm

**T45406 22pc 1/2" Dr. 12pt Socket Set**  
10, 11, 12, 13, 14, 15, 16, 17, 18, 19, 20, 21, 22, 23, 24, 25, 26, 27, 28, 29, 30, 32mm

**T45403 12pc 1/2" Dr. 6pt Deep Socket Set**  
10, 12, 13, 14, 15, 16, 17, 18, 19, 21, 22, 24mm

**T45434 12pc 1/2" Dr. 12pt Deep Socket Set**  
10, 12, 13, 14, 15, 16, 17, 18, 19, 21, 22, 24mm

**T45506 5pc 1/2" Dr. 6pt Jumbo Socket Set**  
15/16", 1", 1-1/16", 1-1/8", 1-1/4"

**T45440 7pc 1/2" Dr. 6pt Jumbo Socket Set**  
21, 22, 24, 27, 30, 32, 36mm

**T45508 5pc 1/2" Dr. 12pt Jumbo Socket Set**  
15/16", 1", 1-1/16", 1-1/8", 1-1/4"

**T45442 6pc 1/2" Dr. 12pt Jumbo Socket Set**  
21, 22, 24, 27, 30, 32mm

**T45441 6pc 1/2" Dr. 6pt Jumbo Deep Socket Set**  
21, 22, 24, 27, 30, 32mm

**T45507 9pc 1/2" Dr. 6pt Jumbo Deep Socket Set**  
3/4", 13/16", 7/8", 15/16", 1", 1-1/16", 1-1/8", 1-1/4", 1-1/2"

**T45443 6pc 1/2" Dr. 12pt Jumbo Deep Socket Set**  
21, 22, 24, 27, 30, 32mm

**T45509 8pc 1/2" Dr. 12pt Jumbo Deep Socket Set**  
3/4", 13/16", 7/8", 15/16", 1", 1-1/16", 1-1/8", 1-1/4"

**T21111 1/4", 3/8", 1/2" Dr. Socket Holder**

- Socket holder designed to hold 1/4", 3/8" or 1/2" Dr. sockets



\* Sockets not included

**Heavy Duty Socket Holder Rails**

- Heavy duty metal rail
- Easy-to-carry, pro style handle
- 14pc socket clips



Model	Size	Length
<b>T21100</b>	1/4" (Black)	17-1/2" 445mm
<b>T21101</b>	3/8" (Red)	17-1/2" 445mm
<b>T21102</b>	1/2" (Blue)	17-1/2" 445mm

**T45040 13pc 1/4" Dr. Socket Set (Metric)**

- Contents:
  - 10 - 1/4" Dr. 6pt Sockets:
    - 4, 5, 6, 7, 8, 9, 10, 11, 12, 13mm
  - 1 - 1/4" Dr. Quick-Release Offset Ratchet
  - 1 - 1/4" Dr. x 3" (75mm) Extension Bar
  - 1 - 1/4" Dr. Universal Joint

**T45235 14pc 3/8" Dr. Socket Set (Metric)**

- Contents:
  - 11 - 3/8" Dr. 6pt Sockets:
    - 8, 10, 11, 12, 13, 14, 15, 16, 17, 18, 19mm
  - 1 - 3/8" Dr. Quick-Release Offset Ratchet
  - 1 - 3/8" Dr. x 3" (75mm) Extension Bar
  - 1 - 3/8" Dr. Universal Joint

**6**
**T45432 14pc 1/2" Dr. Socket Set (Metric)**

- Contents:
  - 11 - 1/2" Dr. 6pt Sockets:
    - 10, 12, 13, 14, 15, 16, 17, 19, 21, 22, 24mm
  - 1 - 1/2" Dr. Quick-Release Offset Ratchet
  - 1 - 1/2" Dr. x 5" (125mm) Extension Bar
  - 1 - 1/2" Dr. Universal Joint

**T45586 7pc 3/8" Dr. Flex Socket Set (SAE)**

3/8", 7/16", 1/2", 9/16", 5/8", 11/16", 3/4"

**T45587 10pc 3/8" Dr. Flex Socket Set (Metric)**

10, 11, 12, 13, 14, 15, 16, 17, 18, 19mm



## Socket Sets



- T45003 10pc 1/4" Dr. 6pt Socket Set**  
4, 5, 6, 7, 8, 9, 10, 11, 12, 13mm
- T45005 12pc 1/4" Dr. 6pt Socket Set**  
4, 5, 5.5, 6, 7, 8, 9, 10, 11, 12, 13, 14mm
- T45102 11pc 1/4" Dr. 6pt Socket Set**  
5/32", 3/16", 7/32", 1/4", 9/32", 5/16", 11/32", 3/8", 7/16", 1/2", 9/16"
- T45201 8pc 3/8" Dr. 6pt Socket Set**  
10, 11, 12, 13, 14, 15, 17, 19
- T45205 14pc 3/8" Dr. 6pt Socket Set**  
6, 7, 8, 9, 10, 11, 12, 13, 14, 15, 16, 17, 18, 19mm
- T45233 12pc 3/8" Dr. 6pt Socket Set**  
8, 10, 12, 13, 14, 15, 16, 17, 18, 19, 21, 22mm
- T45236 12pc 3/8" Dr. 12pt Socket Set**  
8, 10, 12, 13, 14, 15, 16, 17, 18, 19, 21, 22mm
- T45301 8pc 3/8" Dr. 6pt Socket Set**  
1/4", 3/8", 7/16", 1/2", 9/16", 5/8", 11/16", 3/4"
- T45304 11pc 3/8" Dr. 6pt Socket Set**  
1/4", 5/16", 3/8", 7/16", 1/2", 9/16", 5/8", 11/16", 3/4", 13/16", 7/8"
- T45407 10pc 1/2" Dr. 12pt Socket Set**  
10, 11, 12, 13, 14, 15, 16, 17, 18, 19mm
- T45503 9pc 1/2" Dr. 6pt Socket Set**  
3/8", 7/16", 1/2", 9/16", 5/8", 11/16", 3/4", 13/16", 7/8"

- T45001 11pc 1/4" Dr. 6pt Deep Socket Set**  
5, 5.5, 6, 7, 8, 9, 10, 11, 12, 13, 14mm
- T45101 7pc 1/4" Dr. 6pt Deep Socket Set**  
1/4", 9/32", 5/16", 11/32", 3/8", 7/16", 1/2"
- T45202 5pc 3/8" Dr. 6pt Deep socket Set**  
10, 12, 13, 14, 15mm
- T45204 10pc 3/8" Dr. 6pt Deep Socket Set**  
10, 11, 12, 13, 14, 15, 16, 17, 18, 19mm
- T45206 14pc 3/8" Dr. 6pt Deep Socket Set**  
6, 7, 8, 9, 10, 11, 12, 13, 14, 15, 16, 17, 18, 19mm
- T45234 12pc 3/8" Dr. 6pt Deep Socket Set**  
8, 10, 12, 13, 14, 15, 16, 17, 18, 19, 21, 22mm
- T45237 12pc 3/8" Dr. 12pt Deep Socket Set**  
8, 10, 12, 13, 14, 15, 16, 17, 18, 19, 21, 22mm
- T45302 5pc 3/8" Dr. 6pt Deep Socket Set**  
7/16", 1/2", 9/16", 5/8", 11/16"
- T45306 10pc 3/8" Dr. 6pt Deep Socket Set**  
5/16", 3/8", 7/16", 1/2", 9/16", 5/8", 11/16", 3/4", 13/16", 7/8"
- T45303 11pc 3/8" Dr. 6pt Deep Socket Set**  
1/4", 5/16", 3/8", 7/16", 1/2", 9/16", 5/8", 11/16", 3/4", 13/16", 7/8"
- T45402 8pc 1/2" Dr. 6pt Deep Socket Set**  
12, 13, 14, 15, 16, 17, 18, 19mm
- T45502 8pc 1/2" Dr. 6pt Deep Socket Set**  
1/2", 9/16", 5/8", 11/16", 3/4", 13/16", 7/8", 15/16"

## Deep Socket Sets







6



### Deep Socket Sets

**T45000 8pc 1/4" Dr. 6pt Deep Socket Set**

5.5, 6, 7, 8, 9, 10, 11, 12mm

**T45100 8pc 1/4" Dr. 6pt Deep Socket Set**

7/32", 1/4", 9/32", 5/16", 11/32", 3/8", 7/16", 1/2"

**T45200 8pc 3/8" Dr. 6pt Deep Socket Set**

10, 11, 12, 13, 14, 16, 17, 19mm

**T45300 8pc 3/8" Dr. 6pt Deep Socket Set**

3/8", 7/16", 1/2", 9/16", 5/8", 11/16", 3/4", 13/16"

**T45400 8pc 1/2" Dr. 6pt Deep Socket Set**

12, 13, 14, 17, 19, 21, 22, 23mm

**T45500 9pc 1/2" Dr. 6pt Deep Socket Set**

1/2", 9/16", 5/8", 11/16", 3/4", 13/16", 7/8", 5/16", 1"

**T45010 18pc 1/4" Dr. Socket Set (Metric)**

- 1/4" Dr. 6pt Sockets: 4 - 13mm



**T45110 16pc 1/4" Dr. Socket Set (SAE)**

- 1/4" Dr. 6pt Sockets: 5/32" - 1/2"



**T45014 18pc 1/4" Dr. Socket Set (Metric)**

- 1/4" Dr. 6pt Sockets: 4 - 13mm



**T45011 22pc 1/4" Dr. Socket Set (Metric)**

- 1/4" Dr. 6pt Sockets: 4 - 12mm
- 1/4" Dr. 6pt Deep Sockets: 6 - 12mm

**T45111 22pc 1/4" Dr. Socket Set (SAE)**

- 1/4" Dr. 6pt Sockets: 3/16" - 1/2"
- 1/4" Dr. 6pt Deep Sockets: 1/4" - 1/2"





### T45012 48pc 1/4" Dr. Socket Set (Metric)

- 1/4" Dr. 6pt Sockets: 4 - 13mm
- 1/4" Dr. 6pt Deep Sockets: 6 - 13mm



### T45210 16pc 3/8" Dr. Socket Set (Metric)

- 3/8" Dr. 6pt Sockets: 8 - 22 mm



### T45211 21pc 3/8" Dr. Socket Set (Metric)

- 3/8" Dr. 6pt Sockets: 9 - 19mm
- 3/8" Dr. 6pt Deep Sockets: 10 - 19mm



### T45212 24pc 3/8" Dr. Socket Set (Metric)

- 3/8" Dr. 6pt Sockets: 6 - 22 mm



### T45510 17pc 1/2" Dr. Socket Set (SAE)

- 1/2" Dr. 6pt Sockets: 7/16" - 1-1/4"

### T45410 17pc 1/2" Dr. Socket Set (Metric)

- 1/2" Dr. 6pt Sockets: 10 - 32mm



### T45411 24pc 1/2" Dr. Socket Set (Metric)

- 1/2" Dr. 6pt Sockets 10 - 32mm



### T45512 24pc 1/2" Dr. Socket Set (SAE)

- 1/2" Dr. 6pt Sockets: 3/8" - 1-1/4"



### T45412 26pc 1/2" Dr. Socket Set (Metric)

- 1/2" Dr. 6pt Sockets: 8 - 32mm





6

### T45414 29pc 1/2" Dr. Socket & Star Bit Set (Metric)

- 1/2" Dr. 6pt Sockets: 10 - 32mm
- 1/2" Dr. 6pt Deep Sockets: 12 - 17mm
- Star Bit Sockets: T20 - T50



### T45415 29pc 1/2" Dr. Socket & Hex Bit Set (Metric)

- 1/2" Dr. 6pt Sockets: 10 - 32mm
- 1/2" Dr. 6pt Deep Sockets: 12 - 17mm
- Hex Bit Sockets: 4 - 10mm



### T45320 39pc 1/4" & 3/8" Dr. Socket Set (SAE & Metric)

- 1/4" Dr. 6pt Sockets: 3/16" - 1/2", 4.5 - 12mm
- 3/8" Dr. 6pt Sockets: 3/8" - 3/4", 9 - 19mm



### T45416 45pc 3/8" & 1/2" Dr. Socket Set (Metric)

- 3/8" Dr. 6pt Sockets: 6 - 19mm
- 1/2" Dr. 6pt Sockets: 10 - 32mm, 3/8" - 1/2"



### T45417 60pc 1/4" & 1/2" Dr. Socket Set (Metric)



- 1/4" Dr. 6pt Sockets: 4 - 10mm
- 1/4" Dr. 6pt Deep Sockets: 8, 10mm
- 1/2" Dr. 6pt Sockets: 10 - 32mm
- 1/2" Dr. 6pt Deep Sockets: 12, 13, 17mm
- 1/4" Bit Sockets (37mm):
  - Phillips: #1, #2
  - Slotted: 4, 5.5mm
  - Star: T10, T20, T25, T30
  - Hex: 4, 5, 6mm
- 1/2" Dr. Bit Sockets (55mm):
  - Phillips: #3
  - Slotted: 8mm
  - Star: T40, T45, T50
  - Hex: 7, 8, 10mm (100mm)





### T45700 14pc 3/4" Dr. Socket Set (6pt) (Metric)

- 3/4" Dr. 6pt Sockets: 22 - 50mm



### T45701 20pc 3/4" Dr. Socket Set (6pt) (Metric)

- 3/4" Dr. 6pt Sockets: 19 - 50mm



### T45740 14pc 3/4" Dr. Socket Set (12pt) (SAE)

- 3/4" Dr. 12pt Sockets: 7/8" - 2"



### T45741 20pc 3/4" Dr. Socket Set (12pt) (SAE)

- 3/4" Dr. 12pt Sockets: 7/8" - 2"



### T45720 14pc 3/4" Dr. Socket Set (12pt) (Metric)

- 3/4" Dr. 12pt Sockets: 22 - 50mm

### T45721 20pc 3/4" Dr. Socket Set (12pt) (Metric)

- 3/4" Dr. 12pt Sockets: 19 - 50mm

### T45762 14pc 1" Dr. 6pt Socket Set (Metric)

- 1" Dr. 6pt Sockets: 36 - 80mm



### T45785 15pc 1" Dr. Socket Set (6pt) (Metric)

- 1" Dr. 6pt Sockets: 36 - 80mm



### T45780 14pc 1" Dr. Socket Set (12pt) (SAE)

- 1" Dr. 12pt Sockets: 1-7/16" - 3-1/8"



### T45781 21pc 1" Dr. Socket Set (12pt) (SAE)

- 1" Dr. 12pt Sockets: 1-7/16" - 3-1/8"



### T45760 14pc 1" Dr. Socket Set (12pt) (Metric)

- 1" Dr. 12pt Sockets: 36 - 80mm

### T45761 21pc 1" Dr. Socket Set (12pt) (Metric)

- 1" Dr. 12pt Sockets: 36 - 80mm

**T45601 44pc 1/4" Dr. Socket Set (SAE & Metric)**

- 1/4" Dr. 6pt Sockets: 5/32" - 1/2", 5.5 - 14mm
- 1/4" Dr. 6pt Deep Sockets: 5/32" ~ 1/2", 5.5 - 14mm

**T45602 55pc 1/4" Dr. Socket Set (SAE & Metric)**

- 1/4" Dr. 6pt Sockets: 5/32" - 1/2", 4 - 13mm

**T45610 22pc 1/4" Dr. Socket Set (SAE & Metric)**

- 1/4" Dr. 6pt Sockets: 5/32" - 1/2", 4 - 13mm

**T45607 38pc 1/4" Dr. Socket Set (Metric)**

- 1/4" Dr. 6pt Sockets: 4 - 13mm
- 1/4" Dr. 6pt Deep Sockets: 6 - 13mm

**T45603 45pc 1/4" Dr. Socket Set (SAE & Metric)**

- 1/4" Dr. 6pt Sockets: 7/32" - 9/16", 4 - 13mm
- 1/4" Dr. 6pt Deep Socket: 6 - 13mm

**T45606 45pc 1/4" Dr. Socket Set (SAE & Metric)**

- 1/4" Dr. 6pt Sockets: 7/32" - 9/16", 4 - 13mm
- 1/4" Dr. 6pt Deep Sockets: 1/4" - 3/8", 7 - 10mm





### T45331 24pc 3/8" Dr. Socket Set (SAE)

- 3/8" Dr. 6pt Sockets: 1/4" - 3/4"
- 3/8" Dr. 6pt Deep Sockets: 1/4" - 3/4"



### T45330 14pc 3/8" Dr. Socket Set (SAE)

- 3/8" Dr. 12pt Sockets: 3/8" - 3/4"
- 3/8" Dr. 12pt Deep Sockets: 3/8" - 9/16"



### T45230 14pc 3/8" Dr. Socket Set (Metric)

- 3/8" Dr. 12pt Sockets: 10 - 17mm
- 3/8" Dr. 12pt Deep Sockets: 12 - 15mm

### T45231 26pc 3/8" Dr. Socket Set (Metric)

- 3/8" Dr. 6pt Sockets: 10 - 19mm
- 3/8" Dr. 6pt Deep Sockets: 10 - 19mm



### T45270 40pc 3/8" Dr. Socket & Bit Set (Metric)

- 3/8" Dr. 6pt Sockets: 8 - 22mm
- 3/8" Dr. 6pt Deep Sockets: 8 - 19mm



### T45260 59pc 3/8" Dr. Socket and Bit Set (Metric)

- 3/8" Dr. 6pt Sockets: 8 - 22mm
- 3/8" Dr. 6pt Deep Sockets: 8 - 19mm



### T45622 35pc 3/8" Dr. Socket Set (SAE & Metric)

- 3/8" Dr. 12pt Sockets: 1/4" - 7/8"
- 3/8" Dr. 12pt Sockets: 6 - 22mm







6

### T45530 27pc 1/2" Dr. Socket Set (SAE)

- 1/2" Dr. 6pt Sockets: 3/8" - 1-1/4"
- 1/2" Dr. 6pt Deep Sockets: 7/16" - 15/16"



### T45470 22pc 1/2" Dr. Socket Set (Metric)

- 1/2" Dr. 6pt Sockets: 10 - 32mm



### T45531 39pc 1/2" Dr. Mechanics Tool Set (Metric)

- 1/2" Dr. 6pt. Sockets: 10 - 24mm



### T45532 47pc 1/2" Dr. Socket Set (SAE & Metric)

- 1/2" Dr. 6pt Sockets: 3/8" - 1-1/4", 10 - 32mm



### T45652 40pc 1/4" & 3/8" Dr. Socket Set (SAE & Metric)

- 1/4" Dr. 6pt Sockets: 5/32" - 1/2", 4 - 8mm
- 3/8" Dr. 12pt Sockets: 3/8" - 3/4", 9 - 19mm



### T45620 41pc 1/4" & 3/8" Dr. Socket Set (SAE & Metric)

- 1/4" Dr. 6pt Sockets: 5/32" - 1/2", 4 - 8mm
- 3/8" Dr. 12pt Sockets: 3/8" - 3/4", 9 - 19mm





### T45658 62pc 1/4" & 3/8" Dr. Socket Set (SAE & Metric)

- 1/4" Dr. 6pt Sockets: 5/32" - 1/2", 4 - 13mm
- 1/4" Dr. 8pt Sockets: 1/4" - 3/8"
- 3/8" Dr. 12pt Sockets: 3/8" - 13/16", 10 - 19mm



### T45480 80pc 1/4" & 1/2" Dr. Socket Set (Metric)

- 1/4" Dr. 6pt Sockets: 4 - 13mm
- 1/4" Dr. 6pt Deep Sockets: 6 - 13mm
- 1/2" Dr. 6pt Sockets: 10 - 27mm



6

### T45462 70pc 1/4" & 1/2" Dr. Socket & Wrench Set (Metric)

- 1/4" Dr. 6pt Sockets: 4 - 13mm
- 1/2" Dr. 6pt Sockets: 10 - 27mm
- Combination Wrenches: 8, 9, 10, 11, 12, 13, 14, 15, 17, 19mm



### T45486 94pc 1/4" & 1/2" Dr. Socket Set (Metric)

- 1/4" Dr. 6pt Sockets: 4 - 13mm
- 1/4" Dr. 6pt Deep Sockets: 6 - 13mm
- 1/2" Dr. 6pt Sockets: 10 - 32mm
- 1/2" Dr. 6pt Deep Sockets: 14 - 19mm



**T45487 98pc 1/4" & 1/2" Dr. Tool Set (Metric)**

- 1/4" Dr. 6pt Sockets: 4 - 14mm
- 1/2" Dr. 6pt Sockets: 14 - 32mm
- 1/2" Dr. 6pt Deep Sockets: 14 - 19mm
- Combination Wrenches:
  - 8, 10, 11, 12, 13, 14, 17, 19, 22mm
- Screwdrivers:
  - Phillips: #1 x 80mm, #2 x 100mm
  - Slotted: 5.5 x 100mm, 6.5 x 150mm
- Precision Screwdrivers:
  - Phillips: #00, #0
  - Slotted: 2, 3, 4mm

**T45488 106pc 1/4" & 1/2" Dr. Socket & Wrench Set (Metric)**

- 1/4" Dr. 6pt Sockets: 4 - 13mm
- 1/4" Dr. 6pt Deep Sockets: 6 - 13mm
- 1/2" Dr. 6pt Sockets: 10 - 32mm
- 1/2" Dr. 6pt Deep Sockets: 14 - 19mm
- Combination Wrenches:
  - 10, 12, 13, 14, 17mm
- 1/4" Bit Sockets:
  - Phillips: #0, #1, #2
  - Slotted: 4, 5.5, 7mm
  - Hex: 3, 4, 5, 6mm
  - Star: T10, T15, T20, T25, T27, T30
  - Pozi: #0, #1, #2

**T45660 96pc 1/4" & 3/8" Dr. Socket Set (SAE & Metric)**

- 1/4" Dr. 6pt Sockets: 5/32" - 9/16", 4.5 - 14mm
- 1/4" Dr. 6pt Deep Sockets: 1/4" - 7/16", 7 - 11mm
- 3/8" Dr. 12pt Sockets: 1/4" - 7/8", 9 - 19mm
- 3/8" Dr. 12pt Deep Sockets: 3/8" - 5/8", 10 - 14mm



## T46072 83pc 1/4" & 1/2" Dr. Tool Set

- 1/4" Dr. 6pt Socket: 4 - 13mm
- 1/4" Dr. 6pt Deep Socket: 9 - 13mm
- 1/2" Dr. 6pt Socket: 10 - 32mm
- Combination Wrench (Metric)  
10, 11, 12, 13, 14, 15, 17, 19mm
- 10" (250mm) Locking Pliers
- 10" (250mm) Water Pump Pliers
- 7" (180mm) Combination Pliers
- Screwdriver:
  - Slotted: 6 x 38mm, 6 x 100mm
  - Phillips: #1 x 38mm (5 x 38mm),  
#2 x 100mm (6 x 100mm),  
#3 x 200mm (8 x 200mm)



6



## T46070 56pc 1/4" & 1/2" Dr. Tool Set

- 1/4" Dr. 6pt Sockets: 4 - 11mm
- 1/2" Dr. 6pt Sockets: 10 - 27mm
- Screwdrivers:
  - Phillips: #1 x 75mm, #2 x 100mm
  - Slotted: 4 x 75mm, 6 x 100mm
- Combination Wrenches:
  - 8, 10, 12, 13, 14, 17, 19mm
- 7" Combination Pliers
- 10" Water Pump Pliers

## T45490 138pc 3/8" & 1/2" Dr. Tool Set (Metric)

- 3/8" Dr. 6pt Sockets: 8 - 19mm
- 3/8" Dr. 6pt Deep Sockets: 8 - 19mm
- 1/2" Dr. 6pt Sockets: 13 - 32mm
- 1/2" Dr. 6pt Deep Sockets: 16 - 21mm
- 1/2" Dr. Air Impact Sockets: 17 - 23mm
- 1/2" Dr. Hex Bit Sockets (100mm): 6, 7, 8, 10mm
- Combination Wrenches:
  - 7, 8, 9, 10, 11, 12, 13, 14, 15, 16, 17, 18, 19mm
- Swivel Socket Wrenches:
  - 10 x 11, 12 x 13, 14 x 15, 16mm x 17mm
- 3/8" Dr. Birdfeet Wrenches:
  - 10, 11, 12, 13, 14, 15, 16, 17, 18, 19mm
- 150mm Diagonal Cutting Pliers
- 150mm Long Nose Pliers
- 240mm Water Pump Pliers





### T45672 65pc 1/4", 3/8" & 1/2" Dr. Socket Set (SAE & Metric)

- 1/4" Dr. 6pt Sockets: 5/32" - 1/2", 4 - 13mm
- 1/4" Dr. 6pt Deep Sockets: 1/4" - 11/32"
- 1/4" Dr. 8pt Sockets: 1/4" - 3/8"
- 3/8" Dr. 12pt Sockets: 3/8" - 13/16", 10 - 19mm
- 3/8" Dr. 12pt Deep Sockets: 3/8" - 9/16"
- 1/2" Dr. 6pt Sockets: 1/2" - 7/8"



### T45681 122pc 1/4", 3/8" & 1/2" Dr. Socket & Wrench Set (SAE & Metric)

- 1/4" Dr. 6pt Sockets: 7/32" - 9/16", 5.5 - 14mm
- 1/4" Dr. 6pt Deep Sockets: 1/4" - 7/16", 7 - 11mm
- 3/8" Dr. 6pt Sockets: 3/8" - 3/4", 10 - 18mm
- 3/8" Dr. 12pt Sockets: 1/4" - 3/4", 9 - 19mm
- 3/8" Dr. 12pt Deep Sockets: 3/8" - 5/8", 10 - 14mm
- 1/2" Dr. 12pt Sockets: 3/4" - 15/16", 17 - 21mm
- Open End Wrenches:
  - 3/8" x 7/16", 1/2" x 9/16"
  - 10 x 11mm, 12 x 14mm



### T45684 151pc 1/4", 3/8" & 1/2" Dr. Socket & Wrench Set (SAE & Metric)

- 1/4" Dr. 6pt Sockets: 7/32" - 9/16", 5.5 - 14mm
- 1/4" Dr. 6pt Deep Sockets: 1/4" - 7/16", 7 - 11mm
- 3/8" Dr. 6pt Sockets: 3/8" - 3/4", 10 - 18mm
- 3/8" Dr. 12pt Sockets: 1/4" - 3/4", 9 - 19mm
- 3/8" Dr. 12pt Deep Sockets: 3/8" - 5/8", 10 - 14mm
- 1/2" Dr. 12pt Sockets: 3/4" - 1-1/8", 17 - 24mm
- Combination Wrenches:
  - 3/8", 7/16", 1/2", 9/16", 5/8", 3/4"
  - 10, 12, 13, 14, 15, 16mm



**T45680 136pc 1/4", 3/8" & 1/2" Dr. Socket & Wrench Set (SAE & Metric)**

- 1/4" Dr. 6pt Sockets: 5/32" - 1/2", 4 - 13mm
- 1/4" Dr. 6pt Deep Sockets: 8 - 12mm
- 3/8" Dr. 12pt Sockets: 3/8" - 7/8", 9 - 19mm
- 3/8" Dr. 12pt Deep Sockets: 13 - 17mm
- 3/8" Dr. E Sockets: E8 - E20
- 1/2" Dr. 6pt Sockets: 15/16" - 1-1/4", 20 - 32mm
- 1/2" Dr. 6pt Impact Sockets: 17 - 23mm
- Combination Wrenches:
  - 8, 10, 12, 13, 14, 16, 17, 18, 19mm



6



**T45690 170pc 1/4", 3/8" & 1/2" Dr. Socket & Wrench Set (SAE & Metric)**

- 1/4" Dr. 6pt Sockets: 5/32" - 9/16", 4.5 - 14mm
- 1/4" Dr. 6pt Deep Sockets: 1/4" - 1/2", 6 - 12mm
- 3/8" Dr. 6pt Sockets: 3/8" - 3/4", 10 - 18mm
- 3/8" Dr. 12pt Sockets: 1/4" - 7/8", 8 - 19mm
- 3/8" Dr. 12pt Deep Sockets: 3/8" - 3/4", 10 - 16mm
- 1/2" Dr. 12pt Sockets: 11/16" - 1-1/8", 17 - 24mm
- Combination Wrenches:
  - 3/8", 7/16", 1/2", 9/16", 5/8", 3/4"
  - 10, 12, 13, 14, 15, 16mm





6

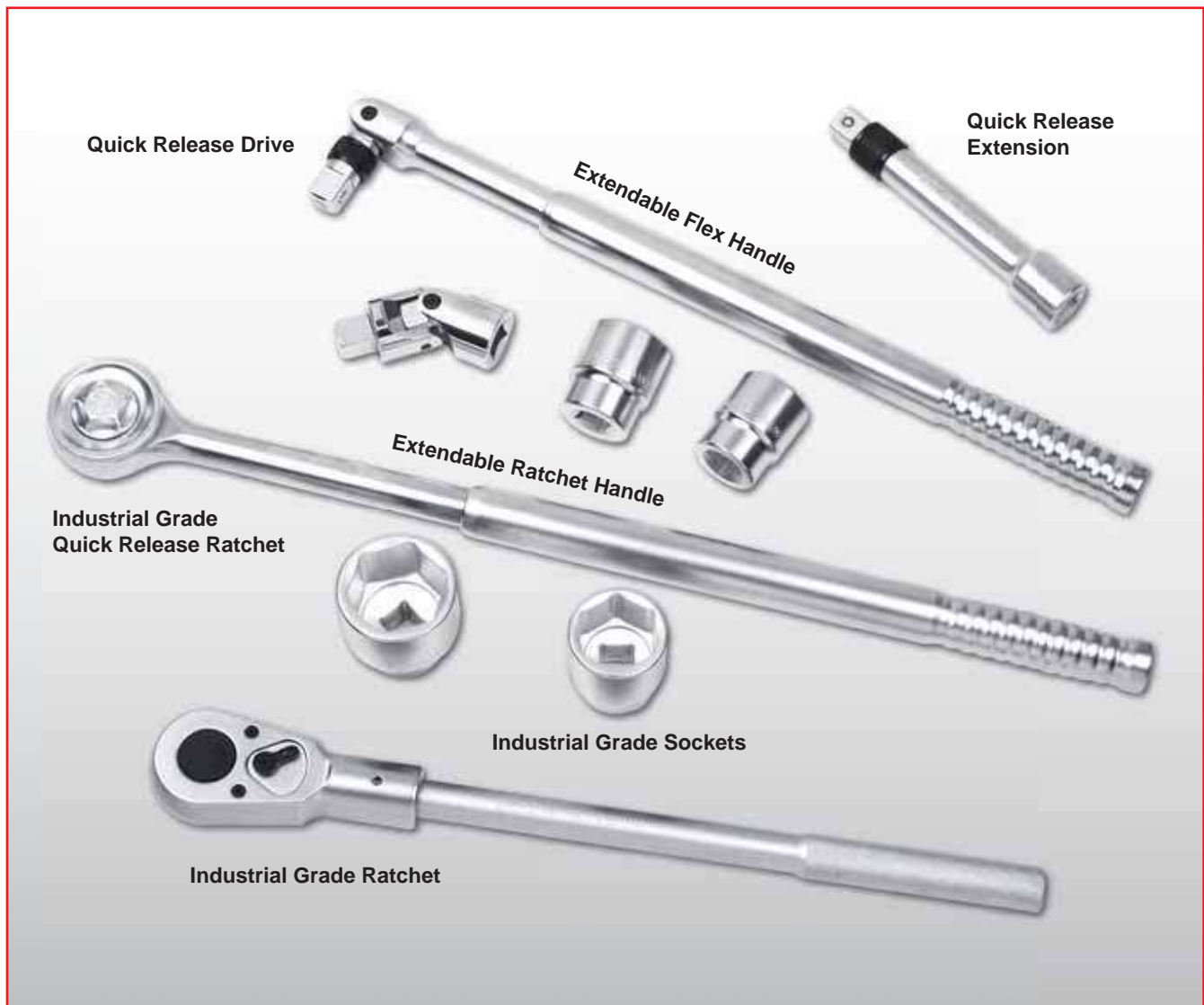

**T45705 17pc 3/4" Dr. 6pt Socket Set w/ Extendable Ratchet (Metric)**

- Contents: (Chrome Vanadium steel)
    - 12 - 3/4" Dr. 6pt Safety Lock Pin Sockets:
      - 17, 19, 22, 24, 27, 30, 32, 36, 38, 41, 46, 50mm
    - 1 - 3/4" Dr. Reversible Ratchet Head (24-Tooth)
    - 1 - Adjustable Ratchet Handle (500 - 815mm)
    - 1 - 3/4" Dr. Sliding T-Adaptor
    - 2 - 3/4" Dr. Extension Bars: 8", 16" (200, 400mm)
- Blowcase



### T45751 21pc 3/4" Dr. 6pt Socket Set (Metric)

### T45755 21pc 3/4" Dr. 12pt Socket Set (Metric)

- Contents: (Chrome Vanadium steel)
    - 16 - 3/4" Dr. Sockets:
      - 19, 21, 22, 23, 24, 26, 27, 29, 30, 32, 35, 36, 38, 41, 46, 50mm
    - 1 - 3/4" Dr. Industrial Reversible Ratchet (40-Tooth)
    - 3 - 3/4" Dr. Extension Bars: 4", 8", 16" (100, 200, 400mm)
    - 1 - 3/4" Dr. Sliding T-Handle (18")
- Blowcase



### T45750 21pc 3/4" Dr. 12pt Socket Set (SAE)

- Contents: (Chrome Vanadium steel)
    - 16 - 3/4" Dr. 12pt Sockets:
      - 7/8", 15/16", 1", 1-1/16", 1-1/8", 1-3/16", 1-1/4", 1-5/16", 1-3/8", 1-7/16", 1-1/2", 1-5/8", 1-3/4", 1-13/16", 1-7/8", 2"
    - 1 - 3/4" Dr. Industrial Rev. Ratchet (40-Tooth)
    - 3 - 3/4" Dr. Extension Bars: 4", 8", 16" (100, 200, 400mm)
    - 1 - 3/4" Dr. Sliding T-Handle (18")
- Blowcase



### T45752 14pc 3/4" Dr. 6pt Socket Set (Metric)

- Contents: (Chrome Vanadium steel)
    - 10 - 3/4" Dr. 6pt Sockets:
      - 22, 24, 27, 30, 32, 36, 38, 41, 46, 50mm
    - 1 - 3/4" Dr. Industrial Quick Release Rev. Ratchet: 20" (43-Tooth)
    - 1 - 3/4" Dr. Sliding T-Handle: 18"
    - 2 - 3/4" Dr. Extension Bars: 4", 8" (100, 200mm)
- Blowcase



### T45710 21pc 3/4" Dr. 6pt Socket Set (Metric)

- Contents: (Chrome Vanadium steel)
  - 16 - 3/4" Dr. 6pt Sockets:
    - 19, 21, 22, 23, 24, 26, 27, 29, 30, 32, 35, 36, 38, 41, 46, 50mm
  - 1 - 3/4" Dr. Extendable Quick Release Rev. Ratchet: 20" (43-Tooth)
  - 1 - 3/4" Dr. Extendable Flex Handle: 20"
  - 3 - 3/4" Dr. Quick Release Extension Bars: 4", 8", 16" (100, 200, 400mm)

Blowcase



### T45753 21pc 3/4" Dr. 6pt Socket Set (Metric)

- Contents: (Chrome Vanadium steel)
  - 16 - 3/4" Dr. 6pt Sockets:
    - 19, 21, 22, 23, 24, 26, 27, 29, 30, 32, 35, 36, 38, 41, 46, 50mm
  - 1 - 3/4" Dr. Industrial Quick Release Rev. Ratchet: 20" (43-Tooth)
  - 1 - 3/4" Dr. Quick Release Sliding T-Handle: 18"
  - 2 - 3/4" Dr. Quick Release Extension Bars: 8", 16" (200, 400mm)
  - 1 - 3/4" Dr. Universal Joint

Blowcase

### T45715 21pc 3/4" Dr. 6pt Socket Set (SAE)

- Contents: (Chrome Vanadium steel)
  - 16 - 3/4" Dr. 6pt Sockets:
    - 7/8", 15/16", 1", 1-1/16", 1-1/8", 1-3/16", 1-1/4", 1-5/16", 1-3/8", 1-7/16", 1-1/2", 1-5/8", 1-3/4", 1-13/16", 1-7/8", 2"
  - 1 - 3/4" Dr. Industrial Quick Release Rev. Ratchet: 20" (43-Tooth)
  - 1 - 3/4" Dr. Sliding T-Handle: 18"
  - 2 - 3/4" Dr. Quick Release Extension Bars: 8", 16" (200, 400mm)
  - 1 - 3/4" Dr. Universal Joint

Blowcase



### T45754 21pc 3/4" Dr. 6pt Socket Set (Metric)

- Contents: (Chrome Vanadium steel)
  - 16 - 3/4" Dr. 6pt Sockets:
    - 19, 21, 22, 23, 24, 26, 27, 29, 30, 32, 35, 36, 38, 41, 46, 50mm
  - 1 - 3/4" Dr. Industrial Quick Release Rev. Ratchet: 20" (43-Tooth)
  - 1 - 3/4" Dr. Flex Handle: 20"
  - 3 - 3/4" Dr. Extension Bars: 4", 8", 16" (100, 200, 400mm)

Blowcase





# Impact Sockets & Socket Sets





### 1/4" Dr. Impact Sockets (Chrome Molybdenum Steel)



7

SAE - 6PT			Metric - 6PT		
Regular	Deep	Size	Regular	Deep	Size
A5920	A5960	3/16"	A5900	A5930	4mm
A5921	A5961	7/32"	A5901	A5931	4.5mm
A5922	A5962	1/4"	A5902	A5932	5mm
A5923	A5963	9/32"	A5903	A5933	5.5mm
A5924	A5964	5/16"	A5904	A5934	6mm
A5925	A5965	11/32"	A5905	A5935	7mm
A5926	A5966	3/8"	A5906	A5936	8mm
A5927	A5967	7/16"	A5907	A5937	9mm
A5928	A5968	1/2"	A5908	A5938	10mm
A5929	A5969	9/16"	A5909	A5939	11mm
			A5910	A5940	12mm
			A5911	A5941	13mm
			A5912	A5942	14mm
			A5913	A5943	15mm

### 3/8" Dr. Impact Sockets (Chrome Molybdenum Steel)



SAE - 6PT			Metric - 6PT		
Regular	Deep	Size	Regular	Deep	Size
A4710	A5410	5/16"	A4506	A4906	6mm
A4711	A5411	3/8"	A4507	A4907	7mm
A4712	A5412	7/16"	A4508	A4908	8mm
A4713	A5413	1/2"	A4509	A4909	9mm
A4714	A5414	9/16"	A4510	A4910	10mm
A4715	A5415	5/8"	A4511	A4911	11mm
A4716	A5416	11/16"	A4512	A4912	12mm
A4717	A5417	3/4"	A4513	A4913	13mm
A4718	A5418	13/16"	A4514	A4914	14mm
A4719	A5419	7/8"	A4515	A4915	15mm
			A4516	A4916	16mm
			A4517	A4917	17mm
			A4518	A4918	18mm
			A4519	A4919	19mm
			A4520	A4920	20mm
			A4521	A4921	21mm
			A4522	A4922	22mm



### 1/2" Dr. Impact Sockets (Chrome Molybdenum Steel)



SAE - 6PT			Metric - 6PT		
Regular	Deep	Size	Regular	Deep	Size
A4750	A5450	5/16"	A4558	A4958	8mm
A4751	A5451	3/8"	A4559	A4959	9mm
A4752	A5452	7/16"	A4560	A4960	10mm
A4753	A5453	1/2"	A4561	A4961	11mm
A4754	A5454	9/16"	A4562	A4962	12mm
A4755	A5455	5/8"	A4563	A4963	13mm
A4756	A5456	11/16"	A4564	A4964	14mm
A4757	A5457	3/4"	A4565	A4965	15mm
A4758	A5458	13/16"	A4566	A4966	16mm
A4759	A5459	7/8"	A4567	A4967	17mm
A4760	A5460	15/16"	A4568	A4968	18mm
A4761	A5461	1"	A4569	A4969	19mm
A4762	A5462	1-1/16"	A4570	A4970	20mm
A4763	A5463	1-1/8"	A4571	A4971	21mm
A4764	A5464	1-3/16"	A4572	A4972	22mm
A4765	A5465	1-1/4"	A4573	A4973	23mm
			A4574	A4974	24mm
			A4575	A4975	25mm
			A4576	A4976	26mm
			A4577	A4977	27mm
			A4578	A4978	28mm
			A4579	A4979	29mm
			A4580	A4980	30mm
			A4581	A4981	31mm
			A4582	A4982	32mm

### 3/4" Dr. Impact Sockets (Chrome Molybdenum Steel)



SAE - 6PT			Metric - 6PT		
Regular	Deep	Size	Regular	Deep	Size
A5120	A5520	11/16"	A4637	A5037	17mm
A5121	A5521	3/4"	A4638	A5038	18mm
A5123	A5523	13/16"	A4639	A5039	19mm
A5124	A5524	7/8"	A4640	A5040	20mm
A5125	A5525	15/16"	A4641	A5041	21mm



**7**

SAE - 6PT			Metric - 6PT		
Regular	Deep	Size	Regular	Deep	Size
A5126	A5526	1"	A4642	A5042	22mm
A5127	A5527	1-1/16"	A4643	A5043	23mm
A5128	A5528	1-1/8"	A4644	A5044	24mm
A5129	A5529	1-3/16"	A4645	A5045	25mm
A5130	A5530	1-1/4"	A4646	A5046	26mm
A5131	A5531	1-5/16"	A4647	A5047	27mm
A5132	A5532	1-3/8"	A4648	A5048	28mm
A5133	A5533	1-7/16"	A4649	A5049	29mm
A5134	A5534	1-1/2"	A4650	A5050	30mm
A5135	A5535	1-9/16"	A4651	A5051	31mm
A5136	A5536	1-5/8"	A4652	A5052	32mm
A5137	A5537	1-11/16"	A4653	A5053	33mm
A5138	A5538	1-3/4"	A4654	A5054	34mm
A5139	A5539	1-13/16"	A4655	A5055	35mm
A5140	A5540	1-7/8"	A4656	A5056	36mm
A5141	A5541	1-15/16"	A4657	A5057	37mm
A5142	A5542	2"	A4658	A5058	38mm
A5143		2-1/16"	A4659		39mm
A5144		2-1/8"	A4660	A5060	40mm
A5145		2-3/16"	A4661	A5061	41mm
A5146		2-1/4"	A4662	A5062	42mm
A5147		2-5/16"	A4663	A5063	43mm
A5148		2-3/8"	A4664		44mm
A5149		2-1/2"	A4665	A5065	45mm
A5150		2-5/8"	A4666	A5066	46mm
A5151		2-3/4"	A4667		47mm
			A4668	A5068	48mm
			A4669	A5069	49mm
			A4670	A5070	50mm
			A4671		51mm
			A4672		52mm
			A4673		53mm
			A4674		54mm
			A4675		55mm
			A4676		56mm
			A4677		57mm
			A4678		58mm
			A4679		59mm
			A4680		60mm
			A4683		63mm
			A4685		65mm
			A4687		67mm
			A4690		70mm

## 1" Dr. Impact Sockets (Chrome Molybdenum Steel)



**7**

SAE - 6PT			Metric - 6PT		
Regular	Deep	Size	Regular	Deep	Size
A5320	A5720	11/16"	A4817	A5217	17mm
A5321	A5721	3/4"	A4819	A5219	19mm
A5323	A5723	13/16"	A4821	A5221	21mm
A5324	A5724	7/8"	A4822	A5222	22mm
A5325	A5725	15/16"	A4823	A5223	23mm
A5326	A5726	1"	A4824	A5224	24mm
A5327	A5727	1-1/16"	A4825	A5225	25mm
A5328	A5728	1-1/8"	A4826	A5226	26mm
A5329	A5729	1-3/16"	A4827	A5227	27mm
A5330	A5730	1-1/4"	A4828	A5228	28mm
A5331	A5731	1-5/16"	A4829	A5229	29mm
A5332	A5732	1-3/8"	A4830	A5230	30mm
A5333	A5733	1-7/16"	A4831	A5231	31mm
A5334	A5734	1-1/2"	A4832	A5232	32mm
A5335	A5735	1-9/16"	A4833	A5233	33mm
A5336	A5736	1-5/8"	A4834	A5234	34mm
A5337	A5737	1-11/16"	A4835	A5235	35mm
A5338	A5738	1-3/4"	A4836	A5236	36mm
A5339	A5739	1-13/16"	A4837	A5237	37mm
A5340	A5740	1-7/8"	A4838	A5238	38mm
A5341	A5741	1-15/16"	A4839	A5239	39mm
A5342	A5742	2"	A4840	A5240	40mm
A5343	A5743	2-1/16"	A4841	A5241	41mm
A5344	A5744	2-1/8"	A4842	A5242	42mm
A5345	A5745	2-3/16"	A4843	A5243	43mm
A5346	A5746	2-1/4"	A4844		44mm
A5347	A5747	2-5/16"	A4846	A5246	46mm
A5348	A5748	2-3/8"	A4847	A5247	47mm
A5350	A5750	2-1/2"	A4848	A5248	48mm
A5352	A5752	2-5/8"	A4849	A5249	49mm
A5354	A5754	2-3/4"	A4850	A5250	50mm
A5355		2-13/16"	A4851	A5251	51mm
	A5756	2-7/8"	A4852	A5252	52mm
A5357	A5757	2-15/16"	A4853		53mm
A5358	A5758	3"	A4854	A5254	54mm
	A5759	3-1/16"	A4855	A5255	55mm
A5360	A5760	3-1/8"	A4856	A5256	56mm
A5362		3-3/8"	A4857	A5257	57mm
A5363		3-1/2"	A4858	A5258	58mm

## 1" Dr. Impact Sockets (Chrome Molybdenum Steel)



Metric - 6PT			Metric - 6PT		
Regular	Deep	Size	Regular	Deep	Size
<b>A4859</b>	<b>A5259</b>	59mm	<b>A4876</b>		76mm
<b>A4860</b>	<b>A5260</b>	60mm	<b>A4878</b>		78mm
<b>A4862</b>		62mm	<b>A4880</b>	<b>A5280</b>	80mm
<b>A4863</b>	<b>A5263</b>	63mm	<b>A4885</b>	<b>A5285</b>	85mm
<b>A4865</b>	<b>A5265</b>	65mm	<b>A4889</b>		89mm
	<b>A5268</b>	68mm	<b>A4890</b>	<b>A5290</b>	90mm
<b>A4870</b>	<b>A5270</b>	70mm	<b>A4895</b>		95mm
<b>A4873</b>		73mm	<b>A4900</b>		100mm
<b>A4875</b>	<b>A5275</b>	75mm			

## 1-1/2" Dr. Impact Sockets (Chrome Molybdenum Steel)



Metric - 6PT			
Regular	Size	Regular	Size
<b>A6700</b>	30mm	<b>A6733</b>	85mm
<b>A6702</b>	32mm	<b>A6734</b>	90mm
<b>A6706</b>	36mm	<b>A6735</b>	95mm
<b>A6711</b>	41mm	<b>A6740</b>	100mm
<b>A6716</b>	46mm	<b>A6741</b>	105mm
<b>A6720</b>	50mm	<b>A6742</b>	110mm
<b>A6721</b>	52mm	<b>A6743</b>	115mm
<b>A6722</b>	54mm	<b>A6744</b>	120mm
<b>A6723</b>	55mm	<b>A6745</b>	125mm
<b>A6724</b>	58mm	<b>A6746</b>	130mm
<b>A6725</b>	60mm	<b>A6747</b>	135mm
<b>A6728</b>	65mm	<b>A6748</b>	140mm
<b>A6730</b>	70mm	<b>A6749</b>	145mm
<b>A6731</b>	75mm	<b>A6750</b>	150mm
<b>A6732</b>	80mm		

## 3/4" Dr. "Square" Impact Sockets (Chrome Molybdenum Steel)



### SAE

Regular	Deep	Size
<b>A5120S</b>	<b>A5520S</b>	11/16"
<b>A5121S</b>	<b>A5521S</b>	3/4"
<b>A5123S</b>	<b>A5523S</b>	13/16"

### Metric

Regular	Deep	Size
<b>A4637S</b>	<b>A5037S</b>	17mm
<b>A4639S</b>	<b>A5039S</b>	19mm
<b>A4641S</b>	<b>A5041S</b>	21mm



## 1" Dr. "Square" Impact Sockets (Chrome Molybdenum Steel)

### SAE

Regular	Deep	Size
<b>A5320S</b>	<b>A5720S</b>	11/16"
<b>A5321S</b>	<b>A5721S</b>	3/4"
<b>A5323S</b>	<b>A5723S</b>	13/16"

### Metric

Regular	Deep	Size
<b>A4817S</b>	<b>A5217S</b>	17mm
<b>A4819S</b>	<b>A5219S</b>	19mm
<b>A4821S</b>	<b>A5221S</b>	21mm



7

## Impact Socket Adaptors (Chrome Molybdenum Steel)

Model	Size
<b>A5810</b>	3/8" Dr. (F) x 1/4" (M)
<b>A5811</b>	3/8" Dr. (F) x 1/2" (M)
<b>A5812</b>	1/2" Dr. (F) x 3/8" (M)
<b>A5813</b>	1/2" Dr. (F) x 3/4" (M)
<b>A5814</b>	3/4" Dr. (F) x 1/2" (M)
<b>A5815</b>	3/4" Dr. (F) x 1" (M)
<b>A5816</b>	1" Dr. (F) x 3/4" (M)
<b>A5817</b>	1" Dr. (F) x 1-1/2" (M)
<b>A5818</b>	1-1/2" Dr. (F) x 1" (M)
<b>A5819</b>	1-1/2" Dr. (F) x 2-1/2" (M)



## Impact Universal Joints (Chrome Molybdenum Steel)

Model	Size
<b>A5800</b>	3/8"
<b>A5801</b>	1/2"
<b>A5802</b>	3/4"
<b>A5803</b>	1"
<b>A5805</b>	1-1/2"



## 1/2" Dr. Thin Wall Deep Impact Sockets (Chrome Molybdenum Steel)

w/o Sleeve	w/ Sleeve	Size	Color
<b>A4967T</b>	<b>A4967TP</b>	17mm	Blue
<b>A4969T</b>	<b>A4969TP</b>	19mm	Yellow
<b>A4971T</b>	<b>A4971TP</b>	21mm	Red
<b>A4972T</b>	<b>A4972TP</b>	22mm	Green



## Impact Extension Bars (Chrome Molybdenum Steel)



Model	Size	Length
<b>A5830</b>	3/8"	3" 75mm
<b>A5831</b>	3/8"	6" 150mm
<b>A5832</b>	1/2"	3" 75mm
<b>A5833</b>	1/2"	5" 125mm
<b>A5834</b>	1/2"	10" 250mm
<b>A5836</b>	3/4"	4" 100mm
<b>A5837</b>	3/4"	6" 150mm
<b>A5838</b>	3/4"	8" 200mm
<b>A5839</b>	3/4"	10" 250mm
<b>A5840</b>	1"	4" 100mm
<b>A5841</b>	1"	6" 150mm
<b>A5842</b>	1"	8" 200mm
<b>A5843</b>	1"	10" 250mm
<b>A5845</b>	1-1/2"	10" 250mm
<b>A5846</b>	1-1/2"	15" 380mm
<b>A5847</b>	1-1/2"	20" 500mm

7

## Impact Extension Bars w/ Aluminum Handle



**Knurled Aluminum Grip Design for Secure Hold**

**Easy-to-Hold when Extension Bar is Rotating**



**Ball Bearing Construction for Smooth Rotation**

Model	Size	Length
<b>A5850</b>	3/8"	7" 175mm
<b>A5851</b>	1/2"	8" 200mm
<b>A5852</b>	3/4"	10" 250mm

## 1/2" Dr. Hex Impact Sockets (Chrome Molybdenum Steel)



Model	Size	Model	Size
<b>A5871</b>	5mm	<b>A5877</b>	14mm
<b>A5872</b>	6mm	<b>A5878</b>	17mm
<b>A5873</b>	7mm	<b>A5879</b>	19mm
<b>A5874</b>	8mm		
<b>A5875</b>	10mm		
<b>A5876</b>	12mm		

## 1/2" Dr. Star Impact Sockets (Chrome Molybdenum Steel)

Model	Size	Model	Size
<b>A5860</b>	T20	<b>A5866</b>	T50
<b>A5861</b>	T25	<b>A5867</b>	T55
<b>A5862</b>	T27	<b>A5868</b>	T60
<b>A5863</b>	T30	<b>A5869</b>	T70
<b>A5864</b>	T40		
<b>A5865</b>	T45		



## Impact Sockets Sets (Chrome Molybdenum Steel)

**T33261 7pc 1/2" Dr. Impact Hex Socket Set**  
 Chrome Molybdenum steel  
 5, 6, 7, 8, 10, 12, 14mm

**T33262 7pc 1/2" Dr. Impact Star Socket Set**  
 Chrome Molybdenum steel  
 T30, T40, T45, T50, T55, T60, T70



**A5600 8pc 3/8" Dr. Impact Socket Set**  
 5/16", 3/8", 7/16", 1/2", 9/16", 5/8", 11/16", 3/4"

**A5601 8pc 3/8" Dr. Impact Socket Set**  
 8, 10, 11, 12, 13, 14, 17, 19mm



**A5602 8pc 3/8" Dr. Deep Impact Socket Set**  
 5/16", 3/8", 7/16", 1/2", 9/16", 5/8", 11/16", 3/4"

**A5603 8pc 3/8" Dr. Deep Impact Socket Set**  
 8, 10, 11, 13, 14, 16, 17, 19mm



**A5610 9pc 1/2" Dr. Impact Socket Set**  
 3/8", 7/16", 1/2", 9/16", 5/8", 11/16", 3/4", 13/16", 7/8"

**A5611 9pc 1/2" Dr. Impact Socket Set**  
 11, 12, 13, 14, 16, 17, 19, 21, 22mm

**A5615 9pc 1/2" Dr. Impact Socket Set**  
 13, 14, 16, 17, 18, 19, 21, 22, 24mm





7



## Impact Sockets Sets (Chrome Molybdenum Steel)

**A5612 10pc 1/2" Dr. Deep Impact Socket Set**  
7/16", 1/2", 9/16", 5/8", 11/16", 3/4", 13/16", 7/8", 15/16", 1"

**A5613 10pc 1/2" Dr. Deep Impact Socket Set**  
11, 12, 13, 14, 16, 17, 19, 21, 22, 24mm

**A5614 10pc 1/2" Dr. Deep Impact Socket Set**  
10, 12, 13, 14, 16, 17, 19, 21, 22, 24mm



**A5620 8pc 3/4" Dr. Impact Socket Set**  
1", 1-1/16", 1-1/8", 1-1/4", 1-5/16", 1-3/8", 1-7/16", 1-1/2"

**A5621 8pc 3/4" Dr. Impact Socket Set**  
26, 27, 29, 30, 32, 35, 36, 38mm

**A5622 8pc 3/4" Dr. Impact Socket Set**  
22, 23, 24, 27, 30, 32, 33, 36mm



**A5623 7pc 3/4" Dr. Deep Impact Socket Set**  
21 Square, 24, 26, 27, 29, 32, 38mm

**A5624 8pc 3/4" Dr. Deep Impact Socket Set**  
1", 1-1/16", 1-1/8", 1-1/4", 1-5/16", 1-3/8", 1-7/16", 1-1/2"

**A5625 8pc 3/4" Dr. Deep Impact Socket Set**  
26, 27, 29, 30, 32, 35, 36, 38mm



**A5626 8pc 3/4" Dr. Deep Impact Socket & Adaptor Set**  
24, 27, 30, 32, 33, 36, 38mm  
3/4" Dr. (F) x 1/2" (M) Adaptor



**A5627 8pc 3/4" Dr. Impact Socket Set**  
26, 27, 29, 30, 32, 35, 36, 38mm

**A5628 8pc 3/4" Dr. Deep Impact Socket Set**  
26, 27, 29, 30, 32, 35, 36, 38mm



## Impact Sockets Sets (Chrome Molybdenum Steel)

- A5640 5pc 1" Dr. Impact Socket Set**  
32, 35, 36, 38, 41mm
- A5641 7pc 1" Dr. Impact Socket Set**  
24, 27, 29, 32, 35, 36, 38mm
- A5630 8pc 1" Dr. Impact Socket Set**  
7/8", 15/16", 1", 1-1/16", 1-1/8", 1-3/16", 1-1/4", 1-1/2"
- A5631 8pc 1" Dr. Impact Socket Set**  
17 Square, 19 Square, 21 Square,  
27, 32, 35, 38, 41mm
- A5632 9pc 1" Dr. Impact Socket Set**  
1", 1-1/8", 1-1/4", 1-3/8", 1-1/2", 1-5/8", 1-3/4", 1-7/8", 2"
- A5633 9pc 1" Dr. Impact Socket Set**  
24, 27, 30, 32, 35, 38, 41, 46, 50mm
- A5638 9pc 1" Dr. Impact Socket Set**  
24, 27, 30, 32, 33, 36, 38, 41, 46mm
- A5642 9pc 1" Dr. Impact Socket**  
27, 30, 32, 35, 36, 38, 41, 46, 50mm



7

- A5634 8pc 1" Dr. Deep Impact Socket Set**  
3/4" Square, 13/16" Square, 1-1/16", 1-1/8", 1-3/16",  
1-1/4", 1-3/8", 1-1/2"
- A5635 8pc 1" Dr. Deep Impact Socket Set**  
17 Square, 19 Square, 21 Square, 27, 32, 35, 38,  
41mm
- A5636 7pc 1" Dr. Deep Impact Socket Set**  
13/16" Square, 15/16", 1", 1-1/16", 1-1/8", 1-1/4", 1-1/2"
- A5637 7pc 1" Dr. Deep Impact Socket Set**  
17 Square, 24, 27, 30, 34, 35, 38mm



- A5639 9pc 1" Dr. Deep Impact Socket & Adaptor Set**  
30, 32, 33, 36, 38, 41, 46, 50mm  
1" Dr. (F) x 3/4" (M) Adaptor



## Impact Sockets Sets (Chrome Vanadium steel)



**A5650** 8pc 3/8" Dr. Impact Socket Set  
5/16", 3/8", 7/16", 1/2", 9/16", 5/8", 11/16", 3/4"

**A5651** 8pc 3/8" Dr. Impact Socket Set  
8, 10, 11, 12, 13, 14, 17, 19mm

7



**A5580** 7pc 3/8" Dr. Flex Impact Socket Set  
3/8", 7/16", 1/2", 9/16", 5/8", 11/16", 3/4"

**A5581** 7pc 3/8" Dr. Flex Impact Socket Set  
10, 11, 12, 13, 14, 16, 17mm

**A5590** 7pc 1/2" Dr. Flex Impact Socket Set  
1/2", 9/16", 5/8", 11/16", 3/4", 13/16", 7/8"

**A5591** 7pc 1/2" Dr. Flex Impact Socket Set  
13, 14, 15, 17, 18, 19, 21mm





# Adjustable Wrenches

Essential Tools  
for the Technician





8



SAE & Metric scale

40% wider opening compared to standard adjustable wrench

### Wide-Jaw Adjustable Wrenches

- Chrome Vanadium steel
- Mirror polished head, matte chrome plated handle
- 40% Wider opening compared to standard adjustable wrench



Model	Size	Jaw Capacity
<b>T39866</b>	6" 150mm	up to 1" (25mm)
<b>T39867</b>	8" 200mm	up to 1-3/16" (30mm)
<b>T39868</b>	10" 250mm	up to 1-7/16" (36mm)
<b>T39869</b>	12" 305mm	up to 1-5/8" (42mm)



SAE & Metric scale

40% wider opening compared to standard adjustable wrench

### Wide-Jaw Adjustable Wrenches

- Chrome Vanadium steel
- Contoured, cushioned grip handle
- 40% Wider opening compared to standard adjustable wrench

Model	Size	Jaw Capacity
<b>T39856</b>	6" 150mm	up to 1" (25mm)
<b>T39857</b>	8" 200mm	up to 1-3/16" (30mm)
<b>T39858</b>	10" 250mm	up to 1-7/16" (36mm)
<b>T39859</b>	12" 305mm	up to 1-5/8" (42mm)



### T39871 3pc Wide-Jaw Adjustable Wrench Set

- 6" (150mm), 8" (200mm), 10" (250mm)





## Adjustable Wrenches

- Chrome Vanadium steel
- Satin chrome plated

Model	Size
<b>T39803</b>	4" 100mm
<b>T39805</b>	6" 150mm
<b>T39807</b>	8" 200mm
<b>T39809</b>	10" 250mm
<b>T39811</b>	12" 300mm
<b>T39813</b>	15" 380mm
<b>T39814</b>	18" 450mm



8

## Adjustable Wrenches

- Chrome Vanadium steel
- Phosphate finish for corrosion resistance

### (A) Standard

- Push forward to close

Model	Size
<b>T39804</b>	4" 100mm
<b>T39806</b>	6" 150mm
<b>T39808</b>	8" 200mm
<b>T39810</b>	10" 250mm
<b>T39812</b>	12" 300mm
<b>T39815</b>	15" 380mm

### (B) Left-Nut

- Push forward to open

Model	Size
<b>T39824</b>	4" 100mm
<b>T39826</b>	6" 150mm
<b>T39828</b>	8" 200mm
<b>T39830</b>	10" 250mm
<b>T39832</b>	12" 300mm
<b>T39835</b>	15" 380mm



(A) Standard

(B) Left-Nut

### **T39821** 3pc Professional Adjustable Wrench Set

6" (150mm), 8" (200mm), 10" (250mm)

### **T39820** 3pc Professional Adjustable Wrench Set

6" (150mm), 8" (200mm), 10" (250mm)

**Bonus Storage Tray Included  
for AmPro Tool Chests**





## Adjustable Wrenches

- Chrome Vanadium steel
- SAE & Metric dual scale
- Contoured, cushion grip handle



Model	Size
<b>T39861</b>	6" 150mm
<b>T39862</b>	8" 200mm
<b>T39863</b>	10" 250mm
<b>T39864</b>	12" 300mm

## T39872 3pc Adjustable Wrench Set

- 6" (150mm), 8" (200mm), 10" (250mm)



8

## T39841 Stubby Adjustable Wrench

- 1" opening capacity
- Stubby handle for easy access
- Precision machined jaws
- SAE & Metric dual scale



## Adjustable & Pipe Stubby Wrenches

- Reversible jaw functions as adjustable wrench and pipe wrench
- Chrome Vanadium steel
- Metric scale
- Contoured, cushioned grip handle



Reversible Jaw



Model	Size	Length	Jaw Capacity
<b>T39844</b>	8"	6" 150mm	25mm

## Adjustable & Pipe Wrenches

- Reversible jaw functions as adjustable wrench and pipe wrench
- Chrome Vanadium steel
- SAE & Metric scale
- Contoured, cushioned grip handle



Model	Size
<b>T39850</b>	6" 150mm
<b>T39851</b>	8" 200mm
<b>T39852</b>	10" 250mm
<b>T39853</b>	12" 300mm

## T39870 3pc Adjustable & Pipe Wrench Set

- 6" (150mm), 8" (200mm), 10" (250mm)



## T28622 6pc Ratcheting Flare Nut Wrench Set

- Contents:  
10, 12, 13, 17, 19, 22mm



8

## Universal Adjustable Wrenches

- Chrome Vanadium steel
- 3 Points fix for high torque
- Applicable to straight nuts

Model	Size	Length
<b>T28610</b>	1/4" to 3/4" 6mm - 19mm	7" 180mm
<b>T28611</b>	5/16" to 7/8" 8mm - 22mm	9" 230mm
<b>T28612</b>	5/8" to 1-1/4" 16mm - 32mm	11" 280mm



## "Tiger Claw" Quick Wrenches

- Heat treated steel for performance and durability
- Spring-loaded pivoting jaw
- Continuous ratcheting action
- Laminated multi-plate steel construction for added strength

Model	Size	Length
<b>T28620</b>	7/16" to 7/8" 10mm - 22mm	8" 200mm
<b>T28621</b>	11/16" to 1-1/4" 17mm - 32mm	11" 280mm





### Aluminum Pipe Wrenches

- Heavy-duty Aluminum is lighter and easier to maneuver
- Heat-treated steel jaws for maximum strength

Model	Size
T39421	8" 200mm
T39422	10" 250mm
T39423	12" 300mm
T39424	14" 355mm
T39425	18" 450mm
T39426	24" 610mm
T39427	36" 910mm
T39428	48" 1220mm



### Pipe Wrenches

- Heavy-duty drop forged steel
- Heat-treated steel jaws for maximum strength

Model	Size
T39401	8" 200mm
T39402	10" 250mm
T39403	12" 300mm
T39404	14" 355mm
T39405	18" 450mm
T39406	24" 610mm
T39407	36" 910mm
T39408	48" 1220mm



### Aluminum Ratcheting Pipe Wrenches

- Heavy-duty aluminum is lighter and easier to maneuver
- V-groove jaw design enables rapid ratcheting action
- Spring-loaded jaw adjusts to work with various sizes
- Groove tooth design provides secure grip
- Thumb trigger allows easy application and removal of work piece



Model	Size
T39440	10" 250mm
T39441	14" 355mm
T39442	18" 450mm





# Professional Wrenches

Geared Wrenches

Fits-All Wrenches

Combination

Wrenches

Box Wrenches

Others ...





## Stubby "Geared" Ratcheting Wrenches

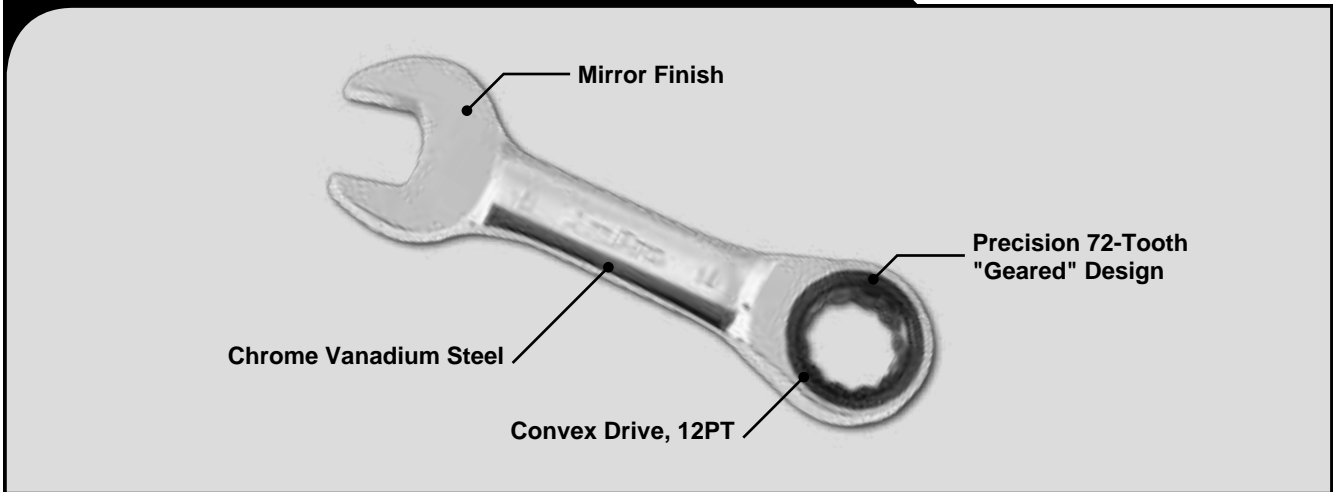

9

Model	Size
T41308	8mm
T41309	9mm
T41310	10mm
T41311	11mm
T41312	12mm
T41313	13mm
T41314	14mm
T41315	15mm
T41316	16mm
T41317	17mm
T41318	18mm
T41319	19mm

Model	Size
T41351	5/16"
T41352	3/8"
T41353	7/16"
T41354	1/2"
T41355	9/16"
T41356	5/8"
T41357	11/16"
T41358	3/4"



**T41382 7pc Stubby Geared Ratcheting Wrench Set**

8, 10, 12, 13, 15, 16, 18mm

**T41383 7pc Stubby Geared Ratcheting Wrench Set**

8, 10, 12, 13, 14, 17, 19mm

**T41392 7pc Stubby Geared Ratcheting Wrench Set**

5/16", 3/8", 7/16", 1/2", 9/16", 5/8", 3/4"

**T41393 7pc Stubby Geared Ratcheting Wrench Set**

3/8", 7/16", 1/2", 9/16", 5/8", 11/16", 3/4"



## Fits-All "Geared" Ratcheting Wrenches

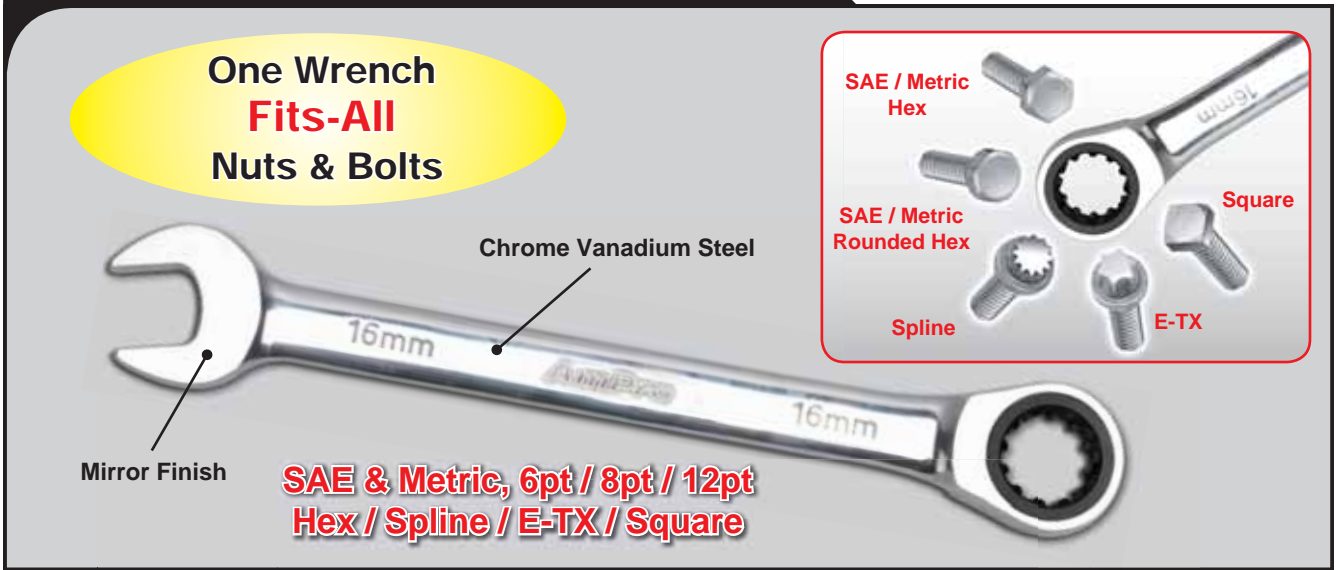

9

## Fits-All "Geared" Ratcheting Wrenches Conversion Table

Model	Size	6PT/12PT Hex (mm)	6PT Round Hex	6PT/12PT (Inch)	E-TX	Square	Spline
T42706	6mm	√	√	1/4"	E8	5	M8
T42707	7mm	√	√	9/32"	x	x	x
T42708	8mm	√	√	5/16"	E10	x	x
T42709	9mm	√	√	11/32"	x	x	M10
T42710	10mm	√	√	3/8"	E12	8	M12
T42711	11mm	√	√	7/16"	E14	9	M14
T42712	12mm	√	√	15/32"	E16	10	x
T42713	13mm	√	√	1/2"	x	x	M16
T42714	14mm	√	√	9/16"	E18	x	x
T42715	15mm	√	√	19/32"	x	12	x
T42716	16mm	√	√	5/8"	E20	13	x
T42717	17mm	√	√	11/16"	x	14	x
T42718	18mm	√	√	23/32"	E22	x	x
T42719	19mm	√	√	3/4"	E24	x	x



**T42751 7pc Fits-All Ratcheting Wrench Set**  
8, 10, 12, 13, 15, 16, 18mm

**T42752 7pc Fits-All Ratcheting Wrench Set**  
10, 12, 13, 14, 15, 17, 19mm

**T42753 12pc Fits-All Ratcheting Wrench Set**  
8, 9, 10, 11, 12, 13, 14, 15, 16, 17, 18, 19mm





## "Geared" Ratcheting Wrenches

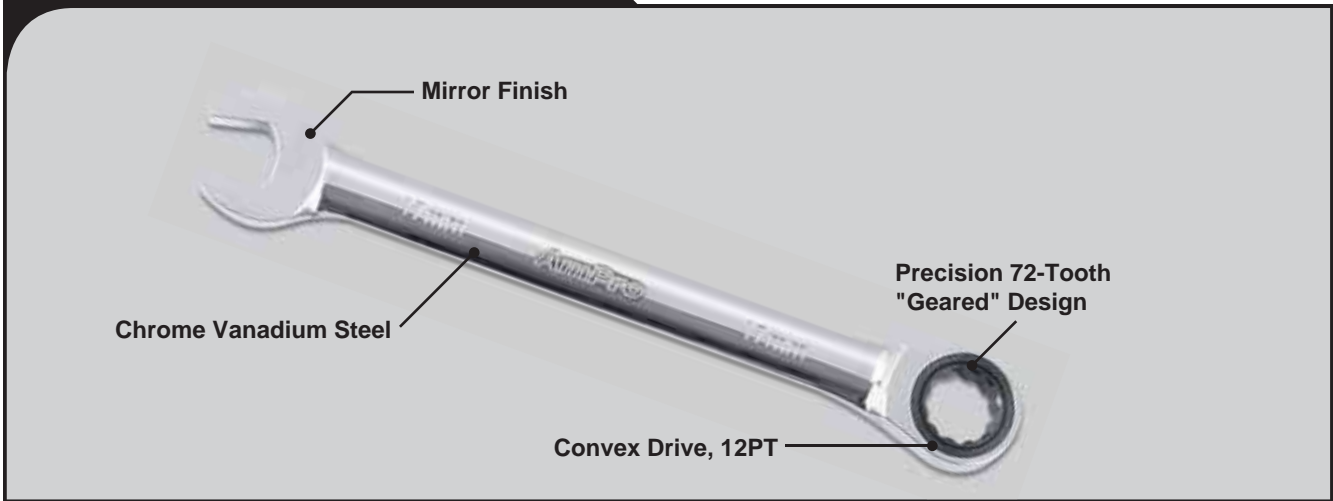

9

Model	Size	Model	Size
T41406	6mm	T41450	1/4"
T41407	7mm	T41451	5/16"
T41408	8mm	T41452	3/8"
T41409	9mm	T41453	7/16"
T41410	10mm	T41454	1/2"
T41411	11mm	T41455	9/16"
T41412	12mm	T41456	5/8"
T41413	13mm	T41457	11/16"
T41414	14mm	T41458	3/4"
T41415	15mm	T41459	13/16"
T41416	16mm	T41460	7/8"
T41417	17mm	T41461	15/16"
T41418	18mm	T41462	1"
T41419	19mm	T41463	1-1/16"
T41421	21mm	T41464	1-1/8"
T41422	22mm	T41465	1-1/4"
T41424	24mm	T41466	1-3/16"
T41427	27mm	T41467	1-3/8"
T41430	30mm	T41468	1-5/16"
T41432	32mm	T41469	1-7/16"
T41434	34mm		
T41436	36mm		



**T41482 4pc Geared Ratcheting Wrench Set**  
10, 12, 13, 14mm

**T41490 4pc Geared Ratcheting Wrench Set**  
3/8", 7/16", 1/2", 9/16"

**T41483 7pc Geared Ratcheting Wrench Set**  
10, 12, 13, 14, 15, 17, 19mm

**T41484 7pc Geared Ratcheting Wrench Set**  
8, 10, 12, 13, 15, 16, 18mm

**T41492 7pc Geared Ratcheting Wrench Set**  
3/8", 7/16", 1/2", 9/16", 5/8", 11/16", 3/4"

**T41493 7pc Geared Ratcheting Wrench Set**  
5/16", 3/8", 7/16", 1/2", 9/16", 5/8", 3/4"



**T41487 12pc Geared Ratcheting Wrench Set**

8, 9, 10, 11, 12, 13, 14, 15, 16, 17, 18, 19mm

**T41494 13pc Geared Ratcheting Wrench Set**

1/4", 5/16", 3/8", 7/16", 1/2", 9/16", 5/8", 3/4", 11/16",  
13/16", 7/8", 15/16", 1"

**T41488 12pc Geared Ratcheting Wrench Set**

8, 9, 10, 11, 12, 13, 14, 15, 16, 17, 18, 19mm





## Stubby Reversible "Geared" Ratcheting Wrenches

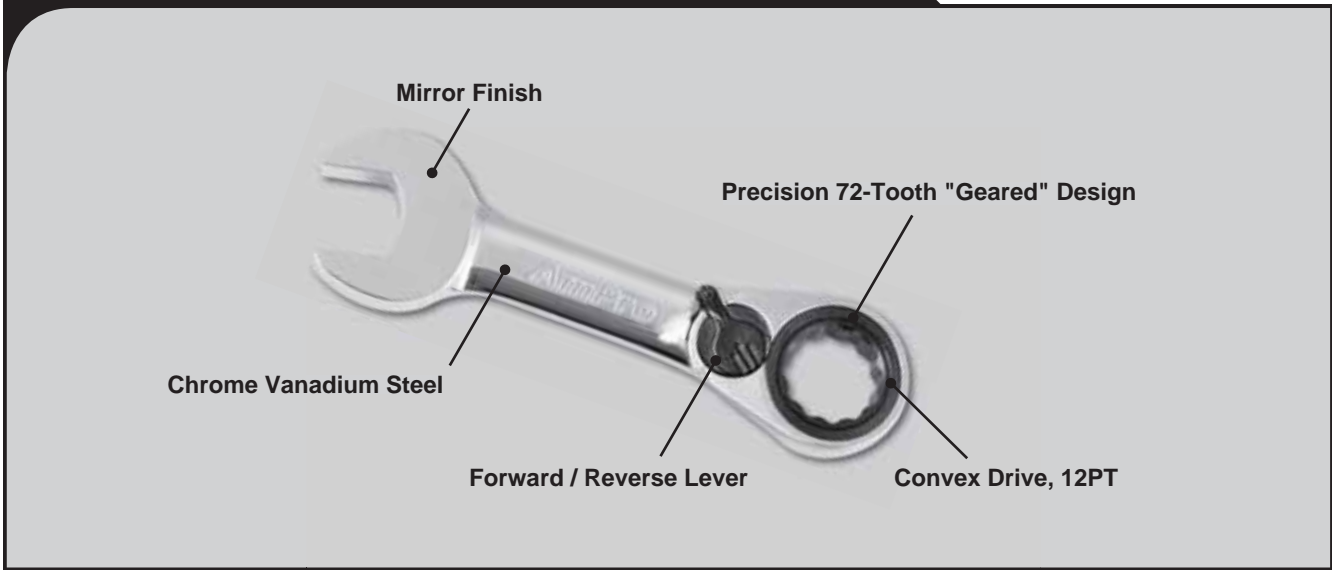

9

Model	Size	Model	Size
T42808	8mm	T42831	5/16"
T42809	9mm	T42832	3/8"
T42810	10mm	T42833	7/16"
T42811	11mm	T42834	1/2"
T42812	12mm	T42835	9/16"
T42813	13mm	T42836	5/8"
T42814	14mm	T42837	11/16"
T42815	15mm	T42838	3/4"
T42816	16mm		
T42817	17mm		
T42818	18mm		
T42819	19mm		



- T42850 7pc Stubby Reversible Geared Ratcheting Wrench Set**  
8, 10, 12, 13, 15, 16, 18mm
- T42851 7pc Stubby Reversible Geared Ratcheting Wrench Set**  
10, 12, 13, 14, 15, 16, 18mm
- T42852 7pc Stubby Reversible Geared Ratcheting Wrench Set**  
10, 12, 13, 14, 15, 17, 19mm
- T42860 7pc Stubby Reversible Geared Ratcheting Wrench Set**  
3/8", 7/16", 1/2", 9/16", 5/8", 11/16", 3/4"
- T42861 7pc Stubby Reversible Geared Ratcheting Wrench Set**  
5/16", 3/8", 7/16", 1/2", 9/16", 5/8", 3/4"



## Reversible "Geared" Ratcheting Wrenches

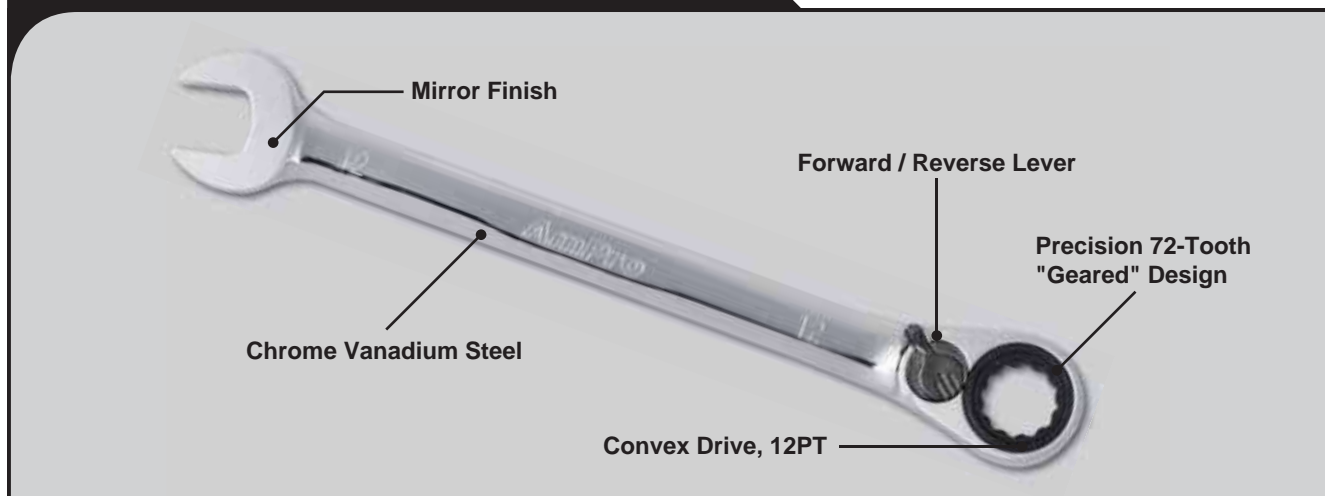

Model	Size
T41608	8mm
T41609	9mm
T41610	10mm
T41611	11mm
T41612	12mm
T41613	13mm
T41614	14mm
T41615	15mm
T41616	16mm
T41617	17mm
T41618	18mm
T41619	19mm
T41621	21mm
T41622	22mm
T41624	24mm
T41627	27mm
T41630	30mm
T41632	32mm

Model	Size
T41651	5/16"
T41652	3/8"
T41653	7/16"
T41654	1/2"
T41655	9/16"
T41656	5/8"
T41657	11/16"
T41658	3/4"
T41659	13/16"
T41660	7/8"
T41661	15/16"
T41662	1"
T41663	1-1/16"
T41664	1-1/8"
T41665	1-1/4"

**T41680 4pc Reversible Geared Ratcheting Wrench Set**

10, 12, 13, 14mm

**T41690 4pc Reversible Geared Ratcheting Wrench Set**

3/8", 7/16", 1/2", 9/16"

**T41683 7pc Reversible Geared Ratcheting Wrench Set**

10, 12, 13, 14, 15, 17, 19mm

**T41684 7pc Reversible Geared Ratcheting Wrench Set**

8, 10, 12, 13, 15, 16, 18mm

**T41685 7pc Reversible Geared Ratcheting Wrench Set**

10, 12, 13, 14, 15, 16, 18mm

**T41692 7pc Reversible Geared Ratcheting Wrench Set**

3/8", 7/16", 1/2", 9/16", 5/8", 11/16", 3/4"

**T41693 7pc Reversible Geared Ratcheting Wrench Set**

5/16", 3/8", 7/16", 1/2", 9/16", 5/8", 3/4"





**T41686 10pc Reversible Geared Ratcheting Wrench Set**

10, 11, 12, 13, 14, 15, 16, 17, 18, 19mm

**T41688 12pc Reversible Geared Ratcheting Wrench Set**

8, 9, 10, 11, 12, 13, 14, 15, 16, 17, 18, 19mm

**T41694 13pc Reversible Geared Ratcheting Wrench Set**

1/4", 5/16", 3/8", 7/16", 1/2", 9/16", 5/8", 3/4", 11/16", 13/16", 7/8", 15/16", 1"



**T41689 12pc Reversible Geared Ratcheting Wrench Set**

8, 9, 10, 11, 12, 13, 14, 15, 16, 17, 18, 19mm



**T41687 8pc Reversible Geared Ratcheting Wrench & Adaptor Set**

- Contents:
  - 4 - Reversible Geared Ratcheting Wrenches:
    - 10, 13, 17, 19mm
  - 3 - Quick-Release Adaptors:
    - 1/4" Dr. for 10mm, 3/8" Dr. for 13mm, 1/2" Dr. for 19mm
  - 1 - Bit Adaptor: 1/4" x 10mm



## Flex-Head Geared Ratcheting Wrenches

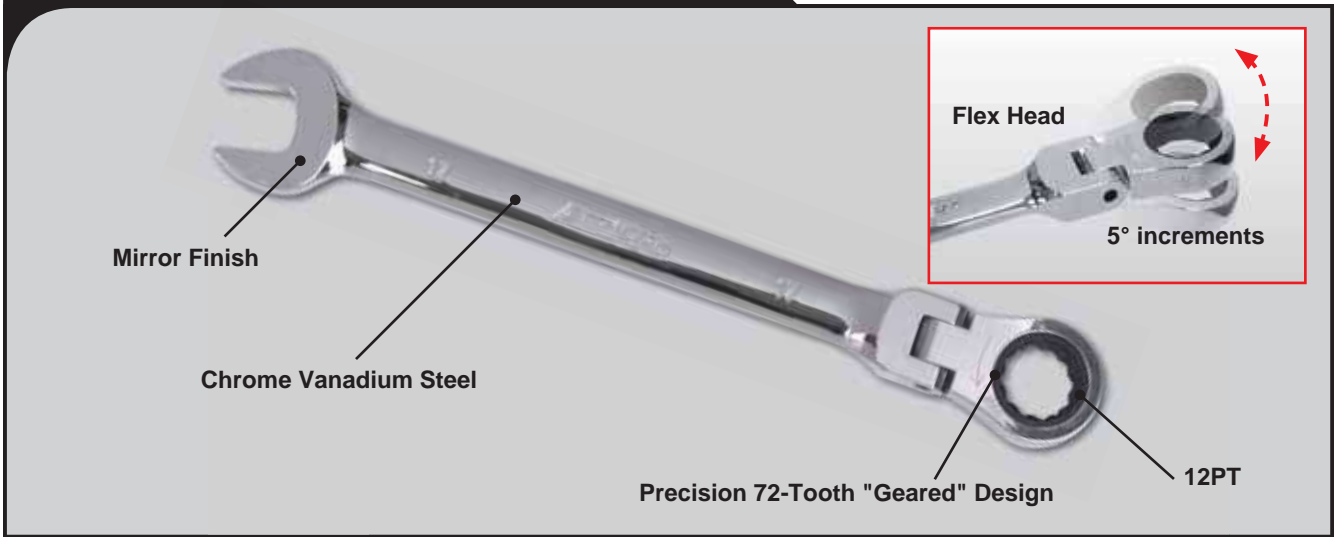

9

Model	Size	Model	Size
T42308	8mm	T42351	5/16"
T42309	9mm	T42352	3/8"
T42310	10mm	T42353	7/16"
T42311	11mm	T42354	1/2"
T42312	12mm	T42355	9/16"
T42313	13mm	T42356	5/8"
T42314	14mm	T42357	11/16"
T42315	15mm	T42358	3/4"
T42316	16mm	T42359	13/16"
T42317	17mm	T42360	7/8"
T42318	18mm	T42361	15/16"
T42319	19mm	T42362	1"
T42321	21mm	T42363	1-1/16"
T42322	22mm	T42364	1-1/8"
T42324	24mm	T42365	1-1/4"
T42327	27mm		
T42330	30mm		
T42332	32mm		

- T42380** 4pc Flex-Head Geared Ratcheting Wrench Set  
10, 12, 13, 14mm
- T42392** 4pc Flex-Head Geared Ratcheting Wrench Set  
3/8", 7/16", 1/2", 9/16"
- T42383** 7pc Flex-Head Geared Ratcheting Wrench Set  
8, 10, 12, 13, 15, 16, 18mm
- T42381** 7pc Flex-Head Geared Ratcheting Wrench Set  
10, 12, 13, 14, 15, 16, 18mm
- T42382** 7pc Flex-Head Geared Ratcheting Wrench Set  
10, 12, 13, 14, 15, 17, 19mm
- T42390** 7pc Flex-Head Geared Ratcheting Wrench Set  
3/8", 7/16", 1/2", 9/16", 5/8", 11/16", 3/4"
- T42391** 7pc Flex-Head Geared Ratcheting Wrench Set  
5/16", 3/8", 7/16", 1/2", 9/16", 5/8", 3/4"







### T42387 12pc Flex-Head Geared Ratcheting Wrench Set

8, 9, 10, 11, 12, 13, 14, 15, 16, 17, 18, 19mm

### T42395 13pc Flex-Head Geared Ratcheting Wrench Set

1/4", 5/16", 3/8", 7/16", 1/2", 9/16", 5/8", 3/4", 11/16", 13/16", 7/8", 15/16", 1"

### T42388 12pc Flex-Head Geared Ratcheting Wrench Set

8, 9, 10, 11, 12, 13, 14, 15, 16, 17, 18, 19mm



9

## Double Flex-Head Geared Ratcheting Wrenches



Model	Size
T42960	8mm x 10mm
T42962	12mm x 13mm
T42963	14mm x 15mm
T42965	17mm x 19mm

Model	Size
T42970	5/16" x 3/8"
T42971	7/16" x 1/2"
T42972	9/16" x 5/8"
T42973	11/16" x 3/4"



### T42980 4pc Double Flex-Head Geared Ratcheting Wrench Set

8 x 10, 12 x 13, 14 x 15, 17mm x 19mm

### T42990 4pc Double Flex-Head Geared Ratcheting Wrench Set

5/16" x 3/8", 7/16" x 1/2", 9/16" x 5/8", 11/16" x 3/4"



### T42550 11pc Extra Long Box Ratcheting Wrench Set

- Contents:
  - 7 - Extra Long Box Ratcheting Wrench: 8, 10, 12, 13, 14, 17, 19mm
  - 3 - Socket Adaptor with Quick-release: 1/4", 3/8", 1/2"
  - 1 - Bit Adaptor: 1/4"



9

### T42555 9pc S-Shape Box End Reversible Ratcheting Wrench Set

- Contents:
  - 5 - S-Shape Box End Reversible Ratcheting Wrench: 10 x 12, 11 x 13, 14 x 16, 15 x 17, 19mm x 22mm
  - 3 - Socket Adaptor with Quick-release: 1/4", 3/8", 1/2"
  - 1 - Bit Adaptor: 1/4"

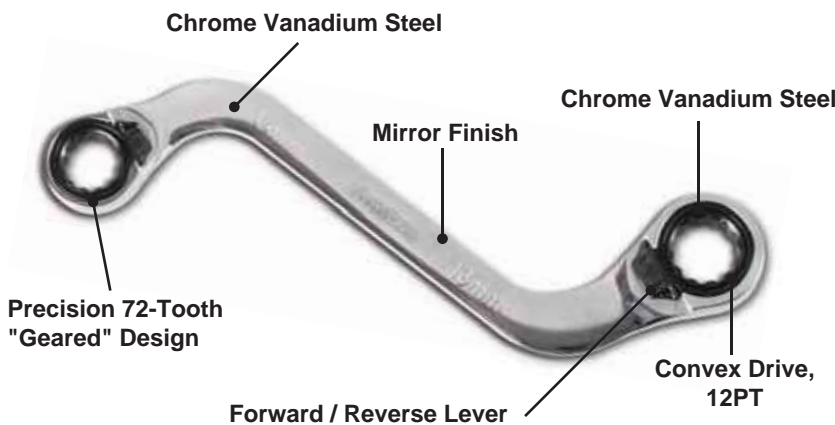



## 4-in-1 Reversible Geared Ratcheting Wrenches

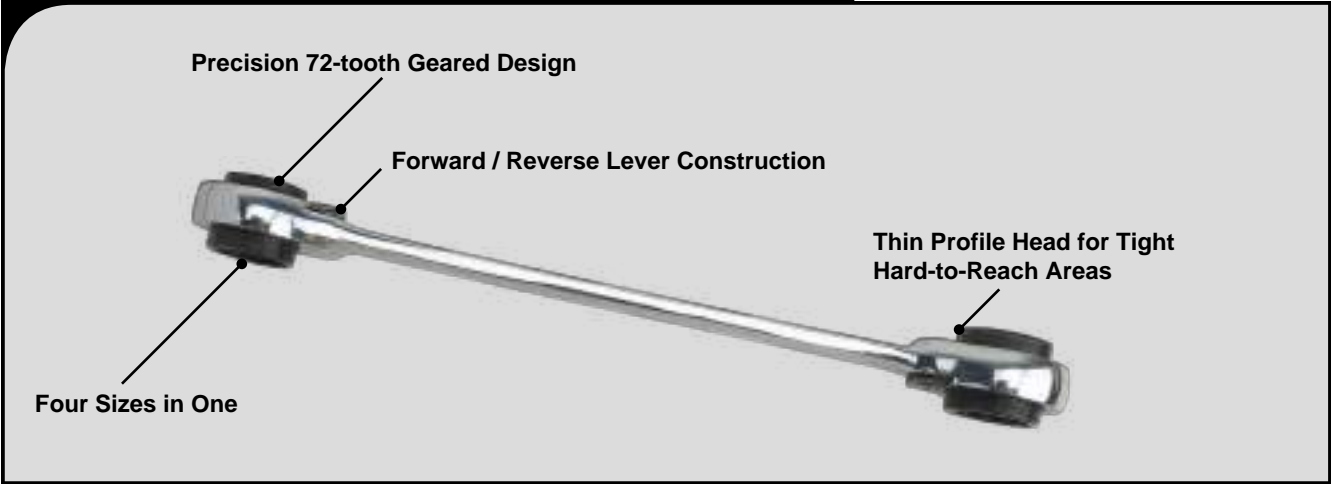

9

Model	Size
T42500	8 x 9mm - 10 x 11mm
T42501	8 x 10mm - 12 x 13mm
T42502	12 x 13mm - 14 x 15mm
T42503	14 x 17mm - 18 x 19mm
T42504	16 x 17mm - 18 x 19mm
T42510	5/16" x 3/8" - 7/16" x 1/2"
T42511	9/16" x 5/8" - 11/16" x 3/4"



**T42515 2pc 8-Size Reversible Geared Ratcheting Wrench Set**

8 x 10 - 12 x 13, 14 x 17 - 18 x 19mm

**T42520 2pc 8-Size Reversible Geared Ratcheting Wrench Set**

5/16" x 3/8" - 7/16" x 1/2", 9/16" x 5/8" - 11/16" x 3/4"



**T42516**

**3pc 12-Size Reversible Geared Ratchet Wrench Set**

8 x 9 - 10 x 11, 12 x 13 - 14 x 15,  
16 x 17 - 18mm x 19mm





## Fits-All Combination Wrenches

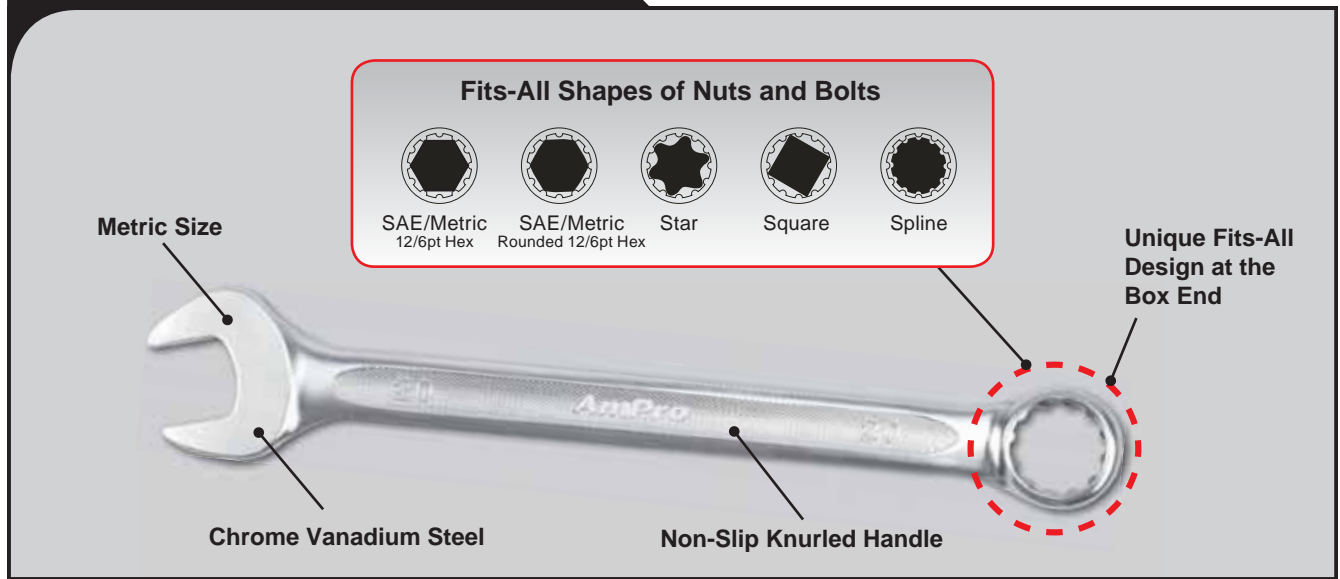

9

### Fits-All Combination Wrenches Conversion Table

Model	Size	6PT/12PT Hex (mm)	6PT Round Hex	6PT/12PT (Inch)	E-TX	Square	Spline
T42606	6mm	√	√	1/4"	E8	5	M8
T42607	7mm	√	√	9/32"	x	x	x
T42608	8mm	√	√	5/16"	E10	x	x
T42609	9mm	√	√	11/32"	x	x	M10
T42610	10mm	√	√	3/8"	E12	8	M12
T42611	11mm	√	√	7/16"	E14	9	M14
T42612	12mm	√	√	15/32"	E16	10	x
T42613	13mm	√	√	1/2"	x	x	M16
T42614	14mm	√	√	9/16"	E18	x	x
T42615	15mm	√	√	19/32"	x	12	x
T42616	16mm	√	√	5/8"	E20	13	x
T42617	17mm	√	√	11/16"	x	14	x
T42618	18mm	√	√	23/32"	E22	x	x
T42619	19mm	√	√	3/4"	E24	x	x
T42620	20mm	√	√	25/32"	x	16	x
T42621	21mm	√	√	13/16"	E26	17	x
T42622	22mm	√	√	7/8"	E28	18	x
T42623	23mm	√	√	x	x	x	x
T42624	24mm	√	√	15/16"	E30	19	x
T42625	25mm	√	√	x	x	x	x
T42626	26mm	√	√	1"	E32	x	x
T42627	27mm	√	√	1-1/16"	E34	22	x
T42628	28mm	√	√	1-1/8"	E36	23	x
T42629	29mm	√	√	x	x	x	x
T42630	30mm	√	√	1-3/16"	E38	24	x
T42632	32mm	√	√	1-1/4"	E40	26	x

**T42670 7pc Fits-All Combination Wrench Set**

10mm (3/8"), 11mm (7/16"), 12mm (15/32"),  
13mm (1/2"), 14mm (9/16"), 15mm (19/32"),  
18mm (23/32")

**T42671 7pc Fits-All Combination Wrench Set**

10mm (3/8"), 12mm (15/32"), 13mm (1/2"),  
14mm (9/16"), 15mm (19/32"), 17mm (11/16"),  
19mm (3/4")

**T42672 9pc Fits-All Combination Wrench Set**

8mm (5/16"), 10mm (3/8"), 11mm (7/16"),  
12mm (15/32"), 13mm (1/2"), 14mm (9/16"),  
15mm (19/32"), 16mm (5/8"), 18mm (23/32")

**T42673 14pc Fits-All Combination Wrench Set**

8mm (5/16"), 9mm (11/32"), 10mm (3/8"),  
11mm (7/16"), 12mm (15/32"), 13mm (1/2"),  
14mm (9/16"), 15mm (19/32"), 16mm (5/8"),  
17mm (11/16"), 19mm (3/4"), 21mm (13/16"),  
22mm (7/8"), 24mm (15/16")

**T42675 26pc Fits-All Combination Wrench Set**

6mm, 7mm, 8mm (5/16"), 9mm (11/32"), 10mm (3/8"),  
11mm (7/16"), 12mm (15/32"), 13mm (1/2"),  
14mm (9/16"), 15mm (19/32"), 16mm (5/8"),  
17mm (11/16"), 18mm, 19mm (3/4"), 20mm (25/32"),  
21mm (13/16"), 22mm (7/8"), 23mm, 24mm (15/16"),  
25mm, 26mm (1"), 27mm (1-1/16"), 28mm (1-1/8"),  
29mm, 30mm (1-3/16"), 32mm (1-1/4")



## 45-Degree Fits-All Box Wrenches

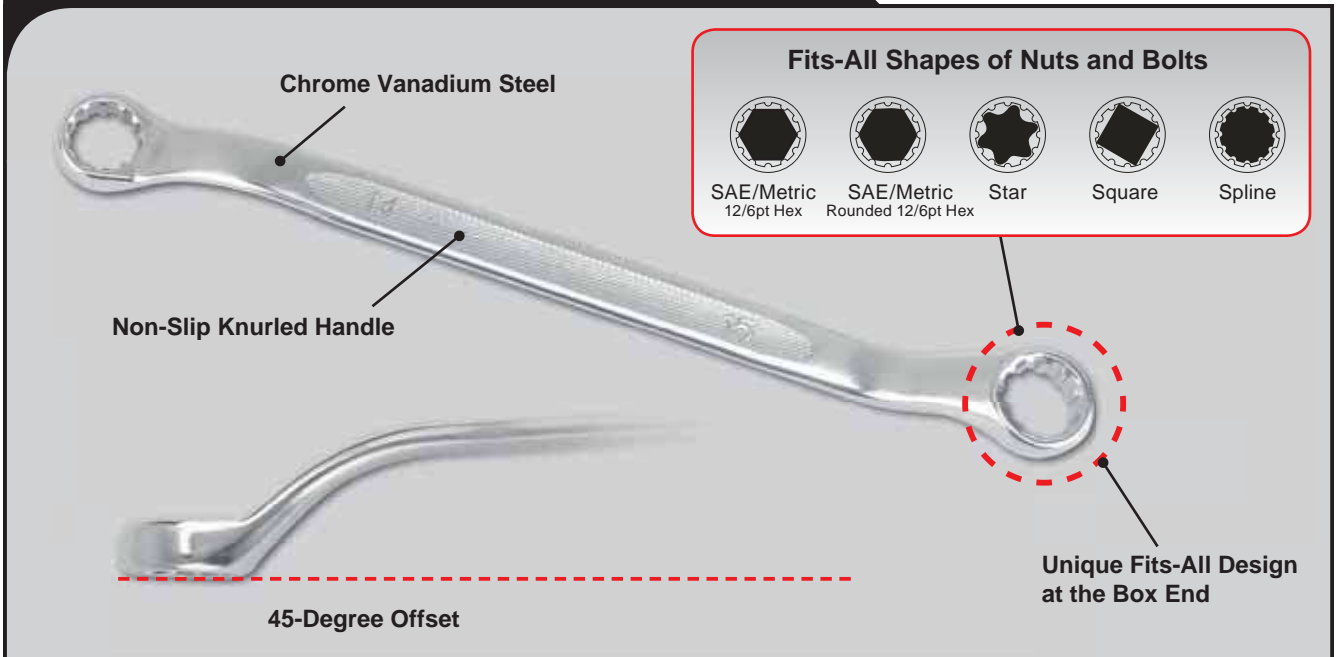

9

### 45-Degree Fits-All Box Wrenches Conversion Table

Size	6PT/12PT Hex (mm)	6PT Round Hex	6PT/12PT (Inch)	E-TX	Square	Spline
6mm	√	√	1/4"	E8	5	M8
7mm	√	√	9/32"	x	x	x
8mm	√	√	5/16"	E10	x	x
9mm	√	√	11/32"	x	x	M10
10mm	√	√	3/8"	E12	8	M12
11mm	√	√	7/16"	E14	9	M14
12mm	√	√	15/32"	E16	10	x
13mm	√	√	1/2"	x	x	M16
14mm	√	√	9/16"	E18	x	x
15mm	√	√	19/32"	x	12	x
16mm	√	√	5/8"	E20	13	x
17mm	√	√	11/16"	x	14	x
18mm	√	√	23/32"	E22	x	x
19mm	√	√	3/4"	E24	x	x
20mm	√	√	25/32"	x	16	x
21mm	√	√	13/16"	E26	17	x
22mm	√	√	7/8"	E28	18	x
23mm	√	√	x	x	x	x
24mm	√	√	15/16"	E30	19	x
25mm	√	√	x	x	x	x
26mm	√	√	1"	E32	x	x
27mm	√	√	1-1/16"	E34	22	x
28mm	√	√	1-1/8"	E36	23	x
29mm	√	√	x	x	x	x
30mm	√	√	1-3/16"	E38	24	x
32mm	√	√	1-1/4"	E40	26	x

Model	Size
T43206	6 x 7mm
T43207	8 x 9mm
T43208	8 x 10mm
T43209	10 x 11mm
T43210	10 x 12mm
T43211	11 x 13mm
T43212	12 x 13mm
T43213	12 x 14mm
T43214	14 x 15mm
T43215	14 x 17mm
T43216	16 x 17mm
T43217	17 x 19mm
T43218	18 x 19mm
T43219	19 x 21mm
T43220	19 x 22mm
T43221	20 x 22mm
T43222	21 x 23mm
T43223	22 x 24mm
T43224	24 x 26mm
T43225	24 x 27mm
T43226	25 x 28mm
T43227	30 x 32mm





### T43240 6pc 45-Degree Fits-All Box Wrench Set

8 x 9, 10 x 11, 12 x 13, 14 x 15, 16 x 17, 18 x 19mm

9

### External Star Wrenches

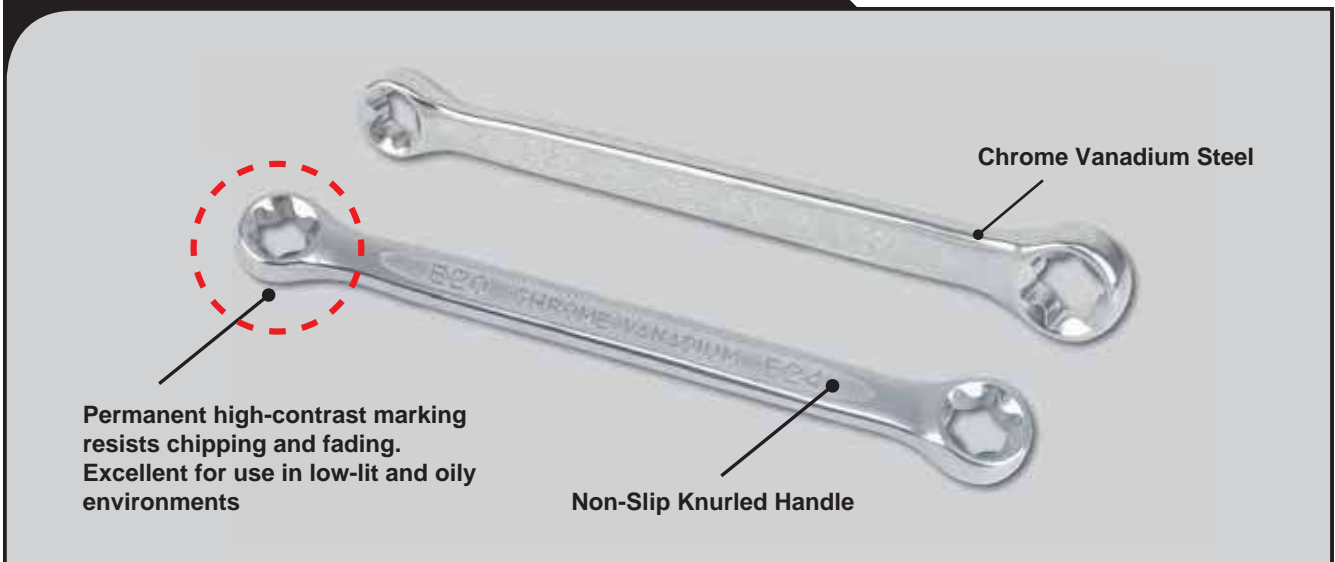

Model	Size
T43104	E6 x E8
T43105	E7 x E11
T43106	E10 x E12
T43108	E14 x E18
T43110	E16 x E22
T43114	E20 x E24



### T43120 4pc External Star Wrench Set

E6 x E8, E10 x E12, E14 x E18, E20 x E24

### T43121 6pc External Star Wrench Set

E6 x E8, E7 x E11, E10 x E12, E14 x E18, E16 x E22, E20 x E24



## "25-Degree Offset" Ratcheting Box Wrenches

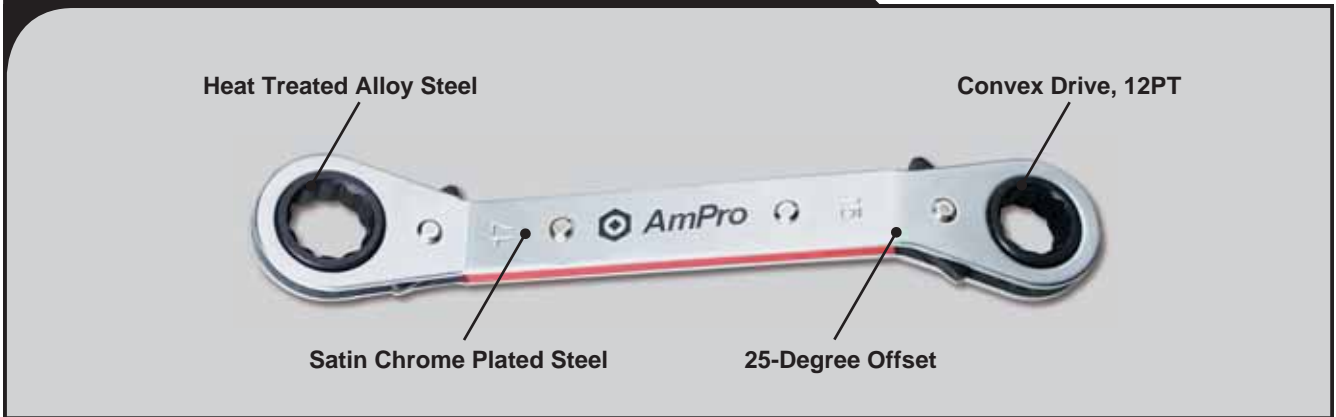

Model	Size	Model	Size	Model	Size
T40801	5.5mm x 7mm	T40811	12mm x 14mm	T40850	1/4" x 5/16"
T40802	6mm x 7mm	T40812	13mm x 14mm	T40851	3/8" x 7/16"
T40803	6mm x 8mm	T40813	13mm x 15mm	T40852	1/2" x 9/16"
T40804	8mm x 9mm	T40814	14mm x 17mm	T40853	5/8" x 11/16"
T40805	8mm x 10mm	T40816	15mm x 17mm	T40854	3/4" x 7/8"
T40806	9mm x 10mm	T40818	17mm x 19mm		
T40807	10mm x 11mm	T40819	17mm x 21mm		
T40808	10mm x 12mm	T40821	19mm x 21mm		
T40809	11mm x 13mm	T40822	19mm x 22mm		
T40810	12mm x 13mm				

### T40895 5pc Offset Ratcheting Box Wrench Set

6 x 8, 10 x 12, 11 x 13, 14 x 17, 19 x 21mm



### T40880 5pc Offset Ratcheting Box Wrench Set

1/4" x 5/16", 3/8" x 7/16", 1/2" x 9/16", 5/8" x 11/16", 3/4" x 7/8"

### T40891 5pc Offset Ratcheting Box Wrench Set

6 x 8, 10 x 11, 13 x 14, 15 x 17, 19mm x 22mm

### T40893 5pc Offset Ratcheting Box Wrench Set

6 x 8, 10 x 12, 11 x 13, 14 x 17, 19mm x 21mm

### T40894 5pc Offset Ratcheting Box Wrench Set

6 x 8, 10 x 12, 13 x 14, 15 x 17, 19mm x 22mm

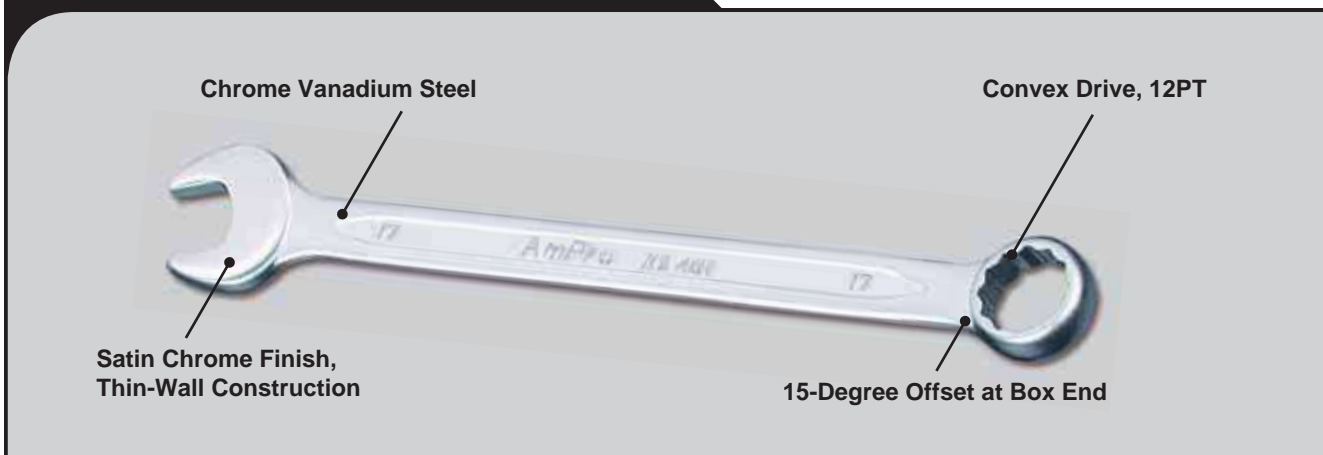

## Thin-Wall Combination Wrenches

**9**

Model	Size	Model	Size	Model	Size	Model	Size
T40106	6mm	T40127	27mm	T40150	1/4"	T40265	1-7/8"
T40107	7mm	T40128	28mm	T40151	5/16"	T40266	2"
T40108	8mm	T40129	29mm	T40152	3/8"	T40267	2-1/16"
T40109	9mm	T40130	30mm	T40153	7/16"	T40268	2-1/8"
T40110	10mm	T40132	32mm	T40154	1/2"	T40269	2-3/16"
T40111	11mm	T40133	33mm	T40155	9/16"	T40270	2-1/4"
T40112	12mm	T40134	34mm	T40156	5/8"	T40271	2-5/16"
T40113	13mm	T40135	35mm	T40157	11/16"	T40272	2-3/8"
T40114	14mm	T40136	36mm	T40158	3/4"	T40273	2-7/16"
T40115	15mm	T40137	38mm	T40159	13/16"	T40274	2-1/2"
T40116	16mm	T40138	41mm	T40160	7/8"	T40275	2-9/16"
T40117	17mm	T40139	43mm	T40161	15/16"	T40276	2-5/8"
T40118	18mm	T40140	46mm	T40162	1"	T40277	2-11/16"
T40119	19mm	T40141	48mm	T40163	1-1/16"	T40278	2-3/4"
T40120	20mm	T40142	50mm	T40164	1-1/8"	T40279	2-13/16"
T40121	21mm	T40143	55mm	T40165	1-1/4"	T40280	2-7/8"
T40122	22mm	T40144	58mm	T40260	1-9/16"	T40281	2-15/16"
T40123	23mm	T40145	60mm	T40261	1-5/8"	T40282	3"
T40124	24mm	T40146	65mm	T40262	1-11/16"		
T40125	25mm	T40147	70mm	T40263	1-3/4"		
T40126	26mm			T40264	1-13/16"		

**T40173 7pc Combination Wrench Set**

10, 12, 13, 14, 15, 17, 19mm

**T40180 12pc Combination Wrench Set**

6, 7, 8, 9, 10, 11, 12, 13, 14, 15, 17, 19mm

**T40181 12pc Combination Wrench Set**

8, 9, 10, 11, 12, 13, 14, 15, 16, 17, 18, 19mm





**T40170 8pc Combination Wrench Set**

6, 7, 8, 9, 10, 13, 17, 19mm

**T40185 14pc Combination Wrench Set**

8, 9, 10, 11, 12, 13, 14, 15, 16, 17, 19, 21, 22, 24mm

**T40186 14pc Combination Wrench Set**

10, 11, 12, 13, 14, 16, 17, 19, 21, 22, 24, 27, 30, 32mm

**T40191 22pc Combination Wrench Set**

10, 11, 12, 13, 14, 15, 16, 17, 18, 19, 20, 21, 22, 23, 24, 25, 26, 27, 28, 29, 30, 32mm



**T40190 18pc Combination Wrench Set**

6, 7, 8, 9, 10, 11, 12, 13, 14, 15, 16, 17, 18, 19, 20, 21, 22, 24mm

**T40195 16pc Combination Wrench Set**

1/4", 5/16", 3/8", 7/16", 1/2", 9/16", 5/8", 11/16", 3/4", 13/16", 7/8", 15/16", 1", 1-1/16", 1-1/8", 1-1/4"

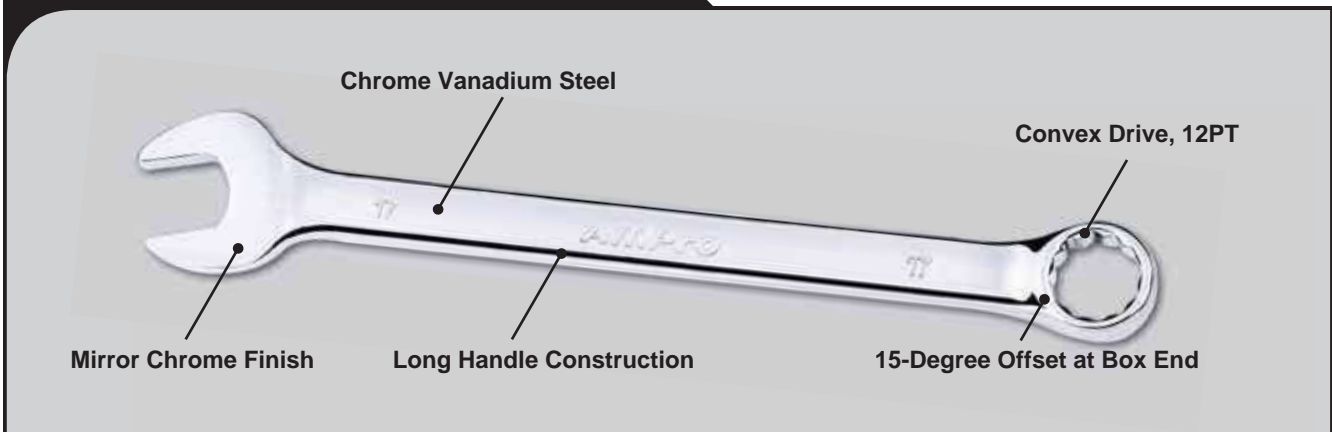

## Long Style Combination Wrenches

**9**

Model	Size	Model	Size	Model	Size	Model	Size
T40006	6mm	T40028	28mm	T40050	1/4"	T40233	1-7/8"
T40007	7mm	T40029	29mm	T40051	5/16"	T40234	2"
T40008	8mm	T40030	30mm	T40052	3/8"	T40235	2-1/16"
T40009	9mm	T40032	32mm	T40053	7/16"	T40236	2-1/8"
T40010	10mm	T40033	33mm	T40054	1/2"	T40237	2-3/16"
T40011	11mm	T40034	34mm	T40055	9/16"	T40238	2-1/4"
T40012	12mm	T40035	35mm	T40056	5/8"	T40239	2-5/16"
T40013	13mm	T40036	36mm	T40057	11/16"	T40240	2-3/8"
T40014	14mm	T40037	37mm	T40058	3/4"	T40241	2-7/16"
T40015	15mm	T40038	38mm	T40059	13/16"	T40242	2-1/2"
T40016	16mm	T40039	41mm	T40060	7/8"	T40243	2-9/16"
T40017	17mm	T40040	42mm	T40061	15/16"	T40244	2-5/8"
T40018	18mm	T40041	45mm	T40062	1"	T40245	2-11/16"
T40019	19mm	T40042	46mm	T40063	1-1/16"	T40246	2-3/4"
T40020	20mm	T40043	48mm	T40064	1-1/8"	T40247	2-13/16"
T40021	21mm	T40044	50mm	T40065	1-1/4"	T40248	2-7/8"
T40022	22mm	T40045	55mm	T40066	1-5/16"	T40249	2-15/16"
T40023	23mm	T40046	58mm	T40067	1-3/8"	T40250	3"
T40024	24mm	T40047	60mm	T40068	1-1/2"		
T40025	25mm	T40048	65mm	T40230	1-9/16"		
T40026	26mm	T40049	70mm	T40231	1-5/8"		
T40027	27mm			T40232	1-3/4"		

**T40081 7pc Combination Wrench Set**

10, 12, 13, 14, 15, 16, 18mm

**T40082 7pc Combination Wrench Set**

10, 12, 13, 14, 15, 17, 19mm

**T40091 7pc Combination Wrench Set**

5/16", 3/8", 7/16", 1/2", 9/16", 5/8", 3/4"



- T40070 8pc Combination Wrench Set**  
6, 7, 8, 9, 10, 13, 17, 19mm
- T40071 8pc Combination Wrench Set**  
10, 11, 12, 13, 14, 15, 17, 19mm
- T40080 12pc Combination Wrench Set**  
6, 7, 8, 9, 10, 11, 12, 13, 14, 15, 17, 19mm
- T40083 14pc Combination Wrench Set**  
6, 7, 8, 9, 10, 11, 12, 13, 14, 15, 16, 17, 18, 19mm
- T40084 19pc Combination Wrench Set**  
10, 11, 12, 13, 14, 15, 16, 17, 18, 19, 20, 21, 22, 23, 24, 27, 29, 30, 32mm
- T40093 9pc Combination Wrench Set**  
1/4", 5/16", 3/8", 7/16", 1/2", 9/16", 5/8", 11/16", 3/4"
- T40094 11pc Combination Wrench Set**  
1/4", 5/16", 3/8", 7/16", 1/2", 9/16", 5/8", 11/16", 3/4", 13/16", 7/8"
- T40096 16pc Combination Wrench Set**  
1/4", 5/16", 3/8", 7/16", 1/2", 9/16", 5/8", 11/16", 3/4", 13/16", 7/8", 15/16, 1", 1-1/16", 1-1/8", 1-1/4"



## Stubby Style Combination Wrenches

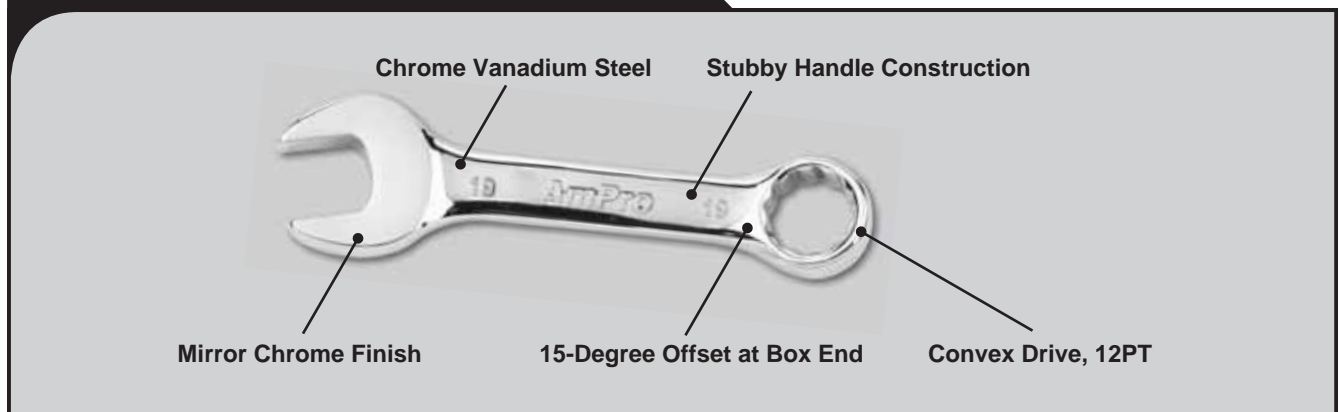

Model	Size	Model	Size
T42008	8mm	T42052	3/8"
T42009	9mm	T42053	7/16"
T42010	10mm	T42054	1/2"
T42011	11mm	T42055	9/16"
T42012	12mm	T42056	5/8"
T42013	13mm	T42057	11/16"
T42014	14mm	T42058	3/4"
T42015	15mm	T42060	7/8"
T42016	16mm		
T42017	17mm		
T42018	18mm		
T42019	19mm		
T42022	22mm		
T42023	23mm		

- T42092 7pc Stubby Combination Wrench Set**  
10, 12, 13, 14, 15, 16, 18mm
- T42093 7pc Stubby Combination Wrench Set**  
10, 12, 13, 14, 15, 17, 19mm
- T42096 7pc Stubby Combination Wrench Set**  
3/8", 7/16", 1/2", 9/16", 5/8", 11/16", 3/4"





## Extra Long Combination Wrenches

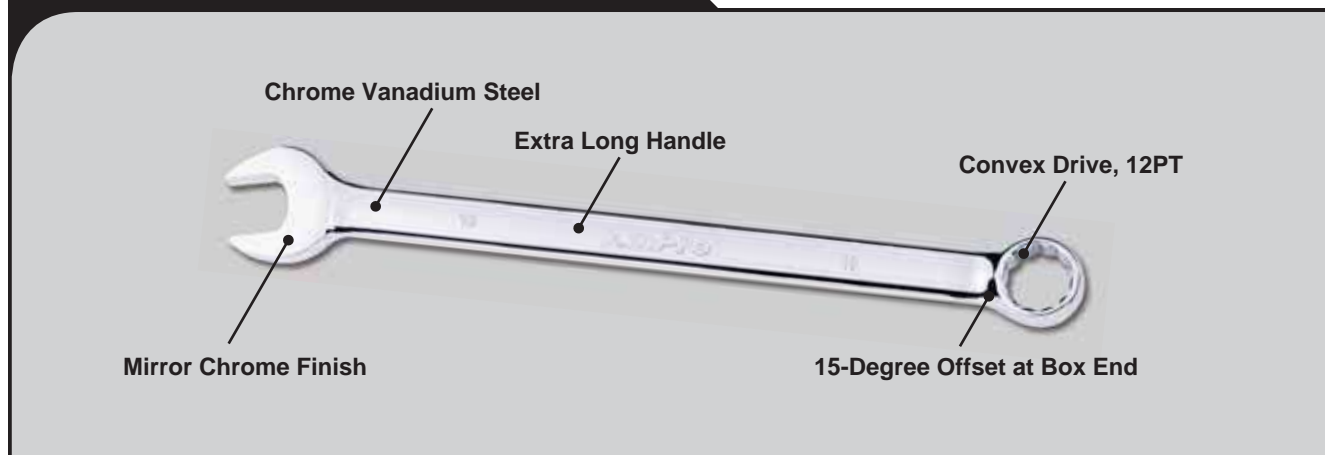

9

Model	Size	Model	Size	Model	Size
T41006	6mm	T41019	19mm	T41050	1/4"
T41007	7mm	T41020	20mm	T41051	5/16"
T41008	8mm	T41021	21mm	T41052	3/8"
T41009	9mm	T41022	22mm	T41053	7/16"
T41010	10mm	T41023	23mm	T41054	1/2"
T41011	11mm	T41024	24mm	T41055	9/16"
T41012	12mm	T41025	25mm	T41056	5/8"
T41013	13mm	T41026	26mm	T41057	11/16"
T41014	14mm	T41027	27mm	T41058	3/4"
T41015	15mm	T41028	28mm	T41059	13/16"
T41016	16mm	T41029	29mm	T41060	7/8"
T41017	17mm	T41030	30mm	T41061	15/16"
T41018	18mm	T41032	32mm		



- T41081 7pc Extra Long Combination Wrench Set**  
10, 11, 12, 13, 14, 15, 17mm
- T41082 9pc Extra Long Combination Wrench Set**  
8, 10, 11, 12, 13, 14, 15, 17, 19mm
- T41083 10pc Extra Long Combination Wrench Set**  
10, 11, 12, 13, 14, 15, 16, 17, 18, 19mm
- T41090 7pc Extra Long Combination Wrench Set**  
5/16", 3/8", 7/16", 1/2", 9/16", 5/8", 11/16"
- T41092 9pc Extra Long Combination Wrench Set**  
1/4", 5/16", 3/8", 7/16", 1/2", 9/16", 5/8", 11/16", 3/4"



## "45-Degree Offset" Combination Wrenches

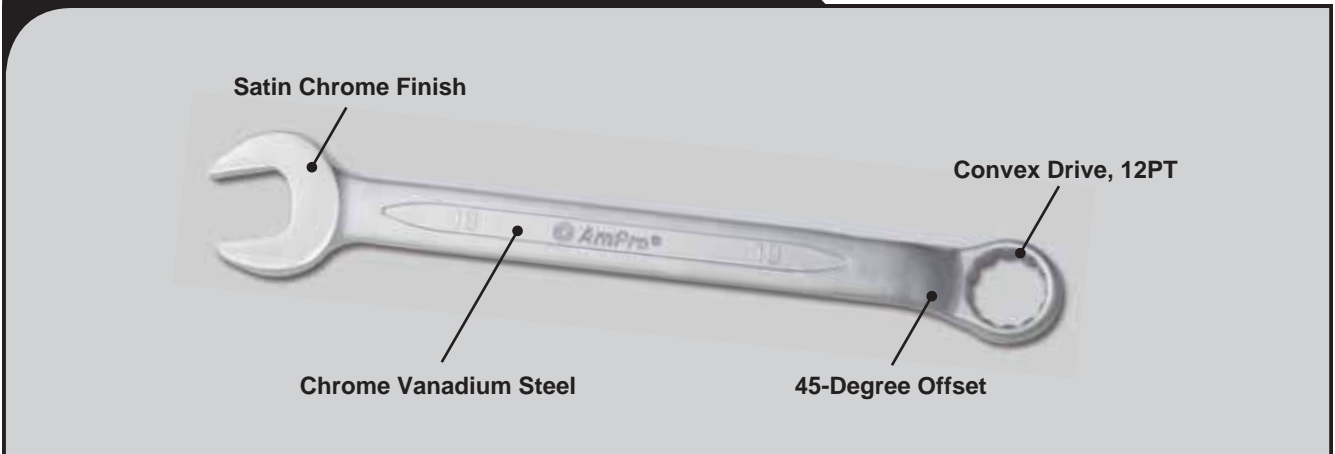

Model	Size	Model	Size	Model	Size	Model	Size
T41206	6mm	T41219	19mm	T41250	1/4"	T41258	3/4"
T41207	7mm	T41220	20mm	T41251	5/16"	T41259	13/16"
T41208	8mm	T41221	21mm	T41252	3/8"	T41260	7/8"
T41209	9mm	T41222	22mm	T41253	7/16"	T41261	15/16"
T41210	10mm	T41223	23mm	T41254	1/2"	T41262	1"
T41211	11mm	T41224	24mm	T41255	9/16"	T41263	1-1/16"
T41212	12mm	T41225	25mm	T41256	5/8"	T41264	1-1/8"
T41213	13mm	T41226	26mm	T41257	11/16"	T41265	1-1/4"
T41214	14mm	T41227	27mm				
T41215	15mm	T41228	28mm				
T41216	16mm	T41229	29mm				
T41217	17mm	T41230	30mm				
T41218	18mm	T41232	32mm				

**T41273 7pc Combination Wrench Set**  
10, 12, 13, 14, 15, 17, 19mm



**T41270 8pc Combination Wrench Set**  
6, 7, 8, 9, 10, 13, 17, 19mm

**T41271 8pc Combination Wrench Set**  
10, 11, 12, 13, 14, 15, 17, 19mm

**T41280 12pc Combination Wrench Set**  
6, 7, 8, 9, 10, 11, 12, 13, 14, 15, 17, 19mm

**T41285 14pc Combination Wrench Set**  
8, 9, 10, 11, 12, 13, 14, 15, 16, 17, 19, 21, 22, 24mm

**T41286 14pc Combination Wrench Set**  
10, 11, 12, 13, 14, 16, 17, 19, 21, 22, 24, 27, 30, 32mm





## Thin-Wall Open-End Wrenches

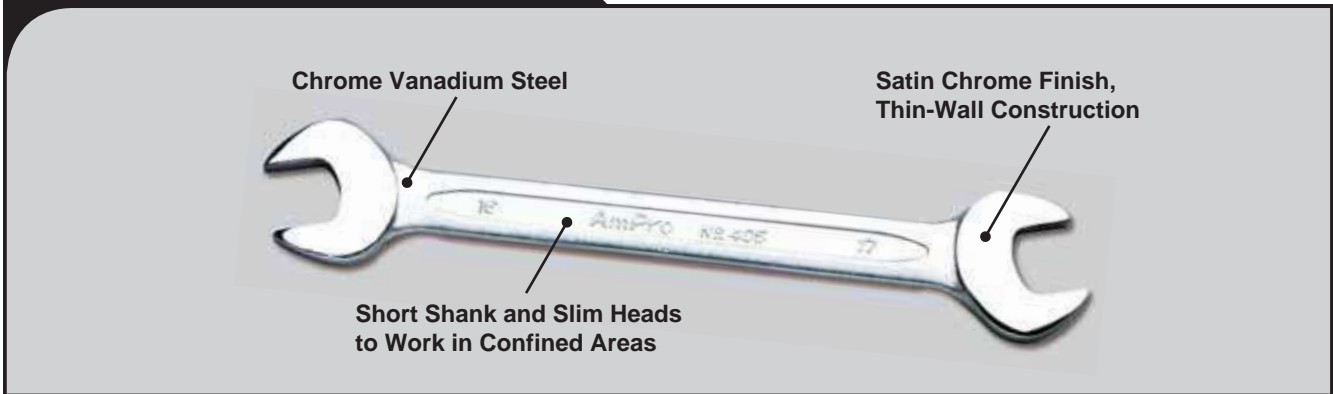

9

Model	Size	Model	Size	Model	Size
T40506	6mm x 7mm	T40518	17mm x 19mm	T40550	1/4" x 5/16"
T40507	6mm x 8mm	T40519	18mm x 19mm	T40551	5/16" x 3/8"
T40508	8mm x 9mm	T40522	20mm x 22mm	T40552	3/8" x 7/16"
T40509	8mm x 10mm	T40523	21mm x 23mm	T40553	7/16" x 1/2"
T40510	10mm x 11mm	T40527	24mm x 27mm	T40555	9/16" x 5/8"
T40511	10mm x 12mm	T40528	25mm x 28mm	T40556	5/8" x 11/16"
T40512	12mm x 13mm	T40532	30mm x 32mm	T40557	11/16" x 3/4"
T40513	12mm x 14mm	T40536	32mm x 36mm	T40559	13/16" x 7/8"
T40514	14mm x 15mm	T40541	36mm x 41mm	T40561	15/16" x 1-1/16"
T40515	14mm x 17mm	T40546	41mm x 46mm	T40563	1" x 1-1/8"
T40517	16mm x 17mm	T40549	46mm x 50mm		



**T40591 8pc Thin-Wall Open-End Wrench Set**  
 8 x 9, 10 x 11, 12 x 13, 14 x 15, 16 x 17, 18 x 19, 20 x 22, 21mm x 23mm

**T40592 12pc Thin-Wall Open-End Wrench Set**  
 6 x 7, 8 x 9, 10 x 11, 12 x 13, 14 x 15, 16 x 17, 18 x 19, 20 x 22, 21 x 23, 24 x 27, 25 x 28, 30mm x 32mm

**T40595 7pc Thin-Wall Open-End Wrench Set**  
 8 x 9, 10 x 11, 12 x 13, 14 x 15, 16 x 17, 18 x 19, 20mm x 22mm

**T40590 6pc Thin-Wall Open-End Wrench Set**  
 8 x 9, 10 x 11, 12 x 13, 14 x 15, 16 x 17, 18mm x 19mm







## Flare Nut Wrenches



Model	Size
T41950	8mm x 9mm
T41951	8mm x 10mm
T41952	9mm x 11mm
T41953	10mm x 11mm
T41954	10mm x 12mm
T41955	11mm x 13mm
T41956	12mm x 13mm
T41957	12mm x 14mm
T41958	13mm x 14mm
T41959	14mm x 17mm
T41960	15mm x 17mm
T41961	16mm x 18mm
T41962	17mm x 19mm
T41964	19mm x 21mm
T41965	19mm x 22mm

Model	Size
T41970	1/4" x 5/16"
T41971	5/16" x 3/8"
T41972	3/8" x 7/16"
T41973	7/16" x 1/2"
T41974	1/2" x 9/16"
T41975	9/16" x 5/8"
T41976	5/8" x 11/16"
T41978	11/16" x 3/4"
T41980	3/4" x 7/8"

- T41990 4pc Flare Nut Wrench Set**  
1/4" x 5/16", 3/8" x 7/16", 1/2" x 9/16", 5/8" x 11/16"
- T41991 4pc Flare Nut Wrench Set**  
9 x 11, 10 x 12, 13 x 14, 16mm x 18mm
- T41992 4pc Flare Nut Wrench Set**  
9 x 11, 10 x 12, 13 x 14, 15mm x 17mm

### Double Flex Flare Nut Wrenches

- Adjustable-angle ends
- Ends rotate up to 240 degrees
- 6 point convex and double offset
- Bottom flare design

- T41940 4pc Double Flex Head Flare Nut Wrench Set**  
8 x 11, 10 x 12, 13 x 17, 14mm x 19mm
- T41945 4pc Double Flex Head Flare Nut Wrench Set**  
5/16" x 7/16", 3/8" x 1/2", 9/16" x 5/8", 11/16" x 3/4"





## “75-Degree” Offset Box Wrenches

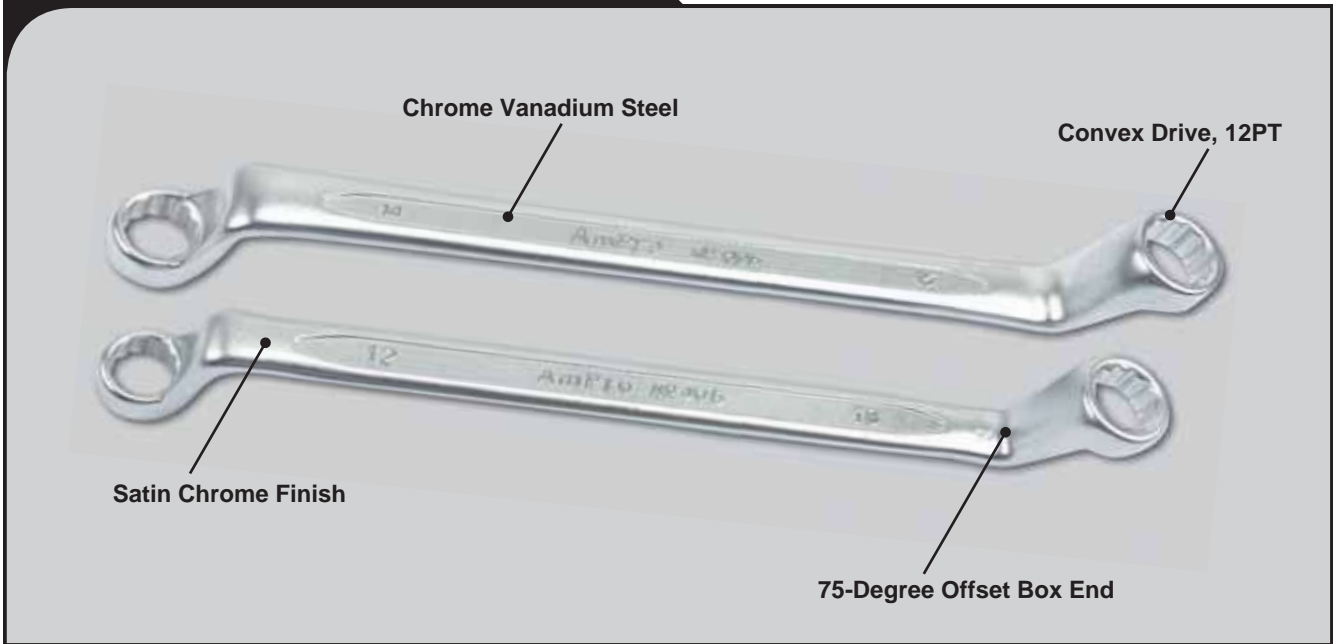

9

Model	Size
T40606	6mm x 7mm
T40608	8mm x 9mm
T40610	10mm x 11mm
T40612	12mm x 13mm
T40614	14mm x 15mm
T40617	16mm x 17mm
T40619	18mm x 19mm
T40622	20mm x 22mm
T40623	21mm x 23mm
T40627	24mm x 27mm
T40628	25mm x 28mm
T40632	30mm x 32mm

Model	Size
T40650	1/4" x 5/16"
T40651	5/16" x 3/8"
T40652	3/8" x 7/16"
T40653	7/16" x 1/2"
T40655	9/16" x 5/8"
T40656	5/8" x 11/16"
T40657	11/16" x 3/4"
T40659	13/16" x 7/8"
T40661	15/16" x 1"
T40662	15/16" x 1-1/16"
T40663	1" x 1-1/8"
T40665	1-1/8" x 1-1/4"



- T40690 6pc Offset Box Wrench Set**  
8 x 9, 10 x 11, 12 x 13, 14 x 15, 16 x 17, 18mm x 19mm
- T40691 8pc Offset Box Wrench Set**  
8 x 9, 10 x 11, 12 x 13, 14 x 15, 16 x 17, 18 x 19, 20 x 22, 21mm x 23mm
- T40692 12pc Offset Box Wrench Set**  
6 x 7, 8 x 9, 10 x 11, 12 x 13, 14 x 15, 16 x 17, 18 x 19, 20 x 22, 21 x 23, 24 x 27, 25 x 28, 30mm x 32mm



### T42460 5pc Extra Long Flat Box End Wrench Set

8 x10, 12 x 14, 13 x 15, 16 x 18, 17mm x 19mm

### T42461 6pc Extra Long Flat Box End Wrench Set

10 x11, 12 x 14, 13 x 15, 16 x 18, 17 x 19, 22mm x 24mm



9

### T42450 5pc Half-Moon Wrench Set

- Perfect for reaching around exhaust manifolds and other obstructions
- Box end provides two compatible sizes on each wrench for consistent fastener engagement
- 12-Point, convex drive
- Chrome Vanadium steel
- Satin chrome finish
- Contents:  
10 x 12, 13 x 15, 14 x 17, 16 x 18, 19mm x 22mm







## Swivel Socket Combination Wrenches

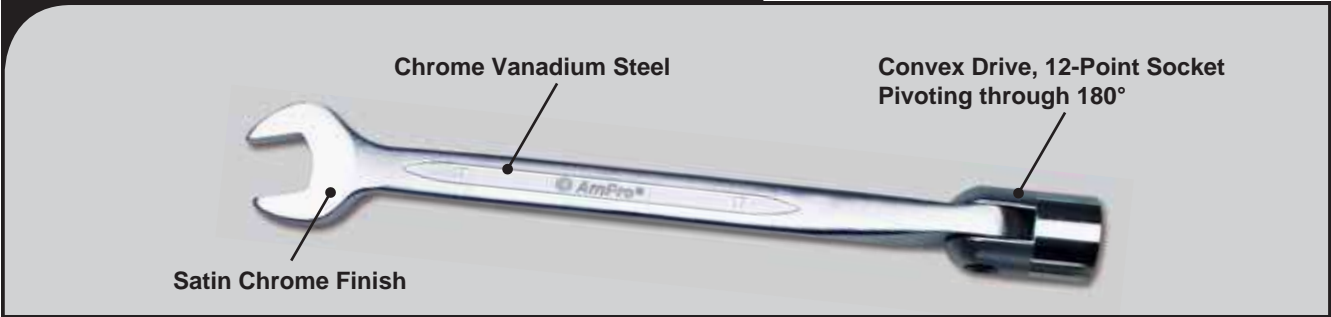

Model	Size
T40960	10mm
T40961	11mm
T40962	12mm
T40963	13mm
T40964	14mm
T40965	15mm
T40966	16mm
T40967	17mm
T40968	18mm
T40969	19mm
T40950	3/8" (Mirror Polish)
T40951	7/16" (Mirror Polish)
T40952	1/2" (Mirror Polish)
T40953	9/16" (Mirror Polish)
T40954	5/8" (Mirror Polish)
T40955	3/4" (Mirror Polish)

### T40990 6pc Swivel Socket Combination Wrench Set

10, 12, 13, 15, 17, 19mm

### T40991 6pc Swivel Socket Combination Wrench Set

3/8", 7/16", 1/2", 9/16", 5/8", 3/4"



## Swivel Socket Wrenches (Convex Drive, 12PT)

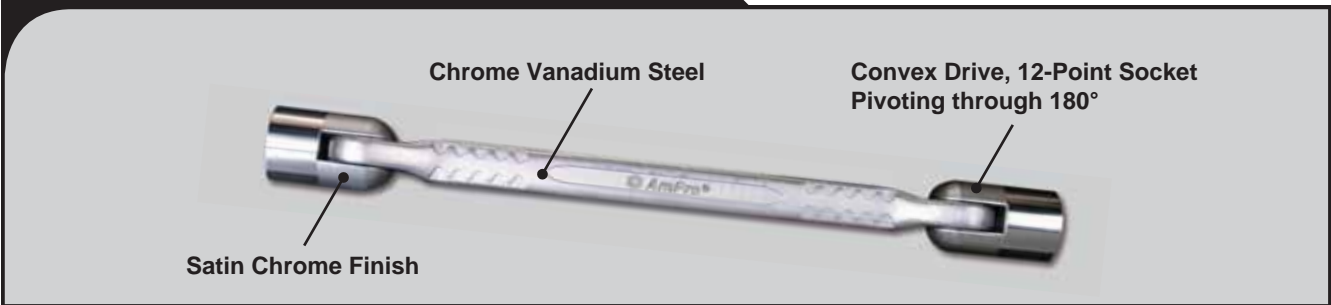

Model	Size
T40909	8mm x 9mm
T40911	10mm x 11mm
T40913	12mm x 13mm
T40915	14mm x 15mm
T40917	16mm x 17mm
T40918	17mm x 19mm
T40919	18mm x 19mm
T40922	20mm x 22mm
T40923	21mm x 23mm
T40930	3/8" x 7/16"
T40931	1/2" x 9/16"
T40932	5/8" x 11/16"
T40933	11/16" x 3/4"
T40934	3/4" x 7/8"

### T40940 6pc Swivel Socket Wrench Set

8 x 9, 10 x 11, 12 x 13, 14 x 15, 16 x 17, 18mm x 19mm





## Angled Socket Wrenches

- Chrome Vanadium Steel
- Mirror finish
- Industrial quality for the professional

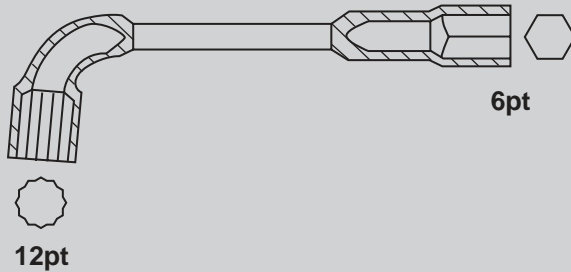

9



### T41880 10pc Angled Socket Wrench Set

8, 10, 11, 12, 13, 14, 16, 17, 18, 19mm

### T41881 12pc Angled Socket Wrench Set

8, 10, 11, 12, 13, 14, 16, 17, 18, 19, 22, 24mm

## Construction Wrenches

- High torque design for heavy duty construction work
- Two sizes in one wrench



Forward & Reverse Lever

Model	Size	Model	Size	Model	Size
T42400	10mm x 12mm	T42409	17mm x 22mm	T42417	24mm x 27mm
T42401	10mm x 13mm	T42410	19mm x 21mm	T42418	24mm x 30mm
T42402	11mm x 13mm	T42411	19mm x 22mm	T42419	26mm x 32mm
T42403	12mm x 14mm	T42412	21mm x 23mm	T42420	27mm x 30mm
T42405	13mm x 17mm	T42413	21mm x 26mm	T42421	27mm x 32mm
T42406	14mm x 17mm	T42414	22mm x 24mm	T42422	30mm x 32mm
T42407	17mm x 19mm	T42415	22mm x 27mm	T42423	32mm x 35mm
T42408	17mm x 21mm	T42416	23mm x 26mm		

## Crowfoot Wrenches

(A)



(B)



### (A) 3/8" Dr. Flex Flare Nut Crowfoot Wrenches

- Adjustable-angle ends
- Rotates up to 180 degrees
- 6 Point convex drive, offset design
- Bottom flare design

#### **T42582 12pc 3/8" Dr. Flex Flare Nut Crowfoot Wrench Set**

8, 9, 10, 11, 12, 13, 14, 15, 16, 17, 18, 19mm

#### **T42583 12pc 3/8" Dr. Flex Flare Nut Crowfoot Wrench Set**

1/4", 5/16", 3/8", 7/16", 1/2", 9/16", 5/8", 11/16", 3/4", 13/16", 7/8", 15/16"

### (B) 3/8" Dr. Flex Offset Box End Wrenches

- Adjustable-angle ends
- Rotates up to 180 degree
- 12 Point convex drive, offset design

#### **T42590 12pc 3/8" Dr. Flex Box End Wrench Set**

8, 9, 10, 11, 12, 13, 14, 15, 16, 17, 18, 19mm

#### **T42591 12pc 3/8" Dr. Flex Box End Wrench Set**

1/4", 5/16", 3/8", 7/16", 1/2", 9/16", 5/8", 11/16", 3/4", 13/16", 7/8", 15/16"



#### **T42586 9pc 1/2" Dr. Flex Flare Nut Crowfoot Wrench Set**

17, 18, 19, 21, 22, 24, 27, 30, 32mm

#### **T42594 9pc 1/2" Dr. Flex Box End Wrench Set**

17, 18, 19, 21, 22, 24, 27, 30, 32mm



### Crowfoot Wrench Sets

- Chrome Molybdenum steel
- Metal rail for easy storage

#### **T42572 10pc 3/8" Dr. Flare Nut Crowfoot Wrench Set (Metric)**

10, 11, 12, 13, 14, 15, 16, 17, 18, 19mm

#### **T42577 11pc 3/8" & 1/2" Dr. Flare Nut Crowfoot Wrench Set (SAE)**

3/8" Dr. : 3/8", 7/16", 1/2", 9/16", 5/8", 11/16", 3/4"  
1/2" Dr. : 13/16", 7/8", 15/16", 1"





**T42571 12pc 3/8" Dr. Flare Nut Crowfoot Wrench Set (SAE)**

- Chrome Molybdenum steel
- Contents:  
5/16", 3/8", 7/16", 1/2", 9/16", 5/8", 11/16", 3/4", 13/16", 7/8",  
15/16", 1"
- Blowcase



**T42570 19pc 3/8" & 1/2" Dr. Flare Nut Crowfoot Wrench Set (Metric)**

- Chrome Molybdenum steel
- Contents:  
3/8" Dr. : 8, 9, 10, 11, 12, 13, 14, 15, 16, 17, 18, 19mm  
1/2" Dr.: 21, 22, 24, 27, 28, 30, 32mm
- Blowcase



**T42573 14pc 1/2" Dr. Crowfoot Wrench Set (Metric)**

- Chrome Molybdenum steel
- Open end wrenches access hard-to-reach fasteners
- Contents:  
14 - 1/2" Dr. Crowfoot Wrenches:  
27, 29, 30, 32, 33, 34, 35, 36, 38, 41, 43, 46, 48, 50mm



**T42580 14pc 1/2" Dr. Crowfoot Wrench Set (SAE)**

- Chrome Molybdenum steel
- Open end wrenches access hard-to-reach fasteners
- Contents:  
14 - 1/2" Dr. Crowfoot Wrenches:  
1-1/16", 1-1/8", 1-3/16", 1-1/4", 1-5/16", 1-3/8", 1-7/16",  
1-1/2", 1-5/8", 1-11/16", 1-3/4", 1-13/16", 1-7/8", 2"
- Blowcase



## Lug Wrenches

### 4-way Foldable Lug Wrenches

- Compact foldable design with quick-release button control

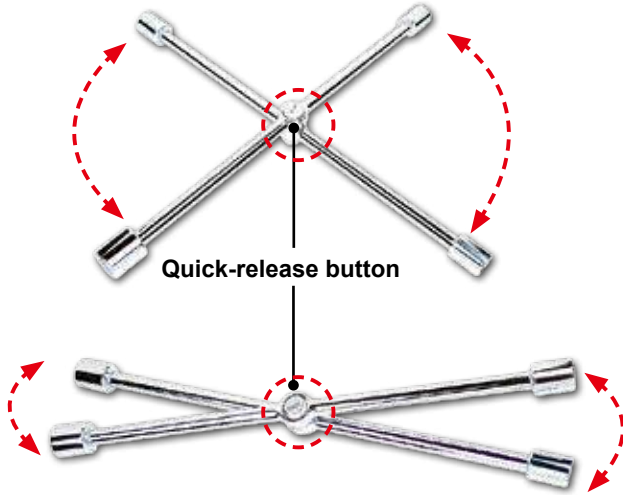

Model	Size	Length
<b>T41730</b>	3/4", 13/16", 7/8", 11/16"	14" 355mm
<b>T41731</b>	17mm, 19mm, 21mm, 23mm	14" 355mm
<b>T41736</b>	17mm, 19mm, 21mm, 23mm	16" 405mm
<b>T41737</b>	17mm, 19mm, 21mm, 1/2" Sq. Dr.	16" 405mm
<b>T41733</b>	3/4", 13/16", 7/8", 11/16"	20" 500mm
<b>T41734</b>	17mm, 19mm, 21mm, 23mm	20" 500mm

### 4-way Lug Wrenches

Model	Size	Length
<b>T41720</b>	3/4", 13/16", 7/8", 11/16"	14" 355mm
<b>T41721</b>	17mm, 19mm, 21mm, 23mm	14" 355mm
<b>T41723</b>	3/4", 13/16", 7/8", 11/16"	20" 500mm
<b>T41724</b>	17mm, 19mm, 21mm, 23mm	20" 500mm

### Folding Lug Wrenches

- Folds up for easy storage
- Chrome Vanadium steel



Model	Size	Length
<b>T41738</b>	17mm, 19mm, 21mm, 23mm	14" 355mm
<b>T41739</b>	11/16", 3/4", 13/16", 7/8"	14" 355mm



### T41729 Extendable Lug Wrench & Socket Set

- Provides more torque than standard lug wrenches
- Extendable wrench handle for convenient usage and storage
- Chrome Vanadium steel
- Extends from 13-1/2" (350mm) to 21-1/2" (550mm)
- 1/2" Dr. fits other 1/2" Dr. socket sizes
- Fits most domestic / foreign cars and light trucks
- 2 - Double Ended Sockets: 17 x 19, 21 x 23mm



### T41740 Lighted Lug Wrench Set

- Compact with 1/2" Dr. reversible double end sockets
- Built-in LED technology automatically turns on when socket is attached
- Extends from 13-1/2" (350mm) to 21-1/2" (550mm)
- Sockets: 17mm (11/16"), 19mm (3/4"), 21mm (13/16"), 23mm (7/8")



### Adjustable Hook Wrenches

- Ideal for adjusting collars, lock nut rings, and bearings
- Adjustable jaw allows to fit different sizes
- Chrome Vanadium steel



Model	Size
T28627	19mm - 50mm (3/4" - 2")
T28628	32mm - 75mm (1-1/4" - 3")
T28629	50mm - 120mm (2" - 4-3/4")





### T41743 Ratcheting Lug Wrench Set (Metric)

- 1/2" Dr. 2-in-1 sockets:  
17 x 19, 21mm x 23mm
- Reversible ratcheting handle

### T41744 Ratcheting Lug Wrench Set (SAE)

- 1/2" Dr. 2-in-1 sockets:  
17mm (11/16") x 3/4", 13/16" x 7/8"
- Reversible ratcheting handle



9

### T41741 Speed Lug Wrench Set (Metric)

- 1/2" Dr. 2-in-1 Sockets: 17 x 19, 21mm x 23mm

### T41742 Speed Lug Wrench Set (SAE)

- 1/2" Dr. 2-in-1 Sockets: 17mm (11/16") x 3/4", 13/16" x 7/8"





# Torque Wrenches

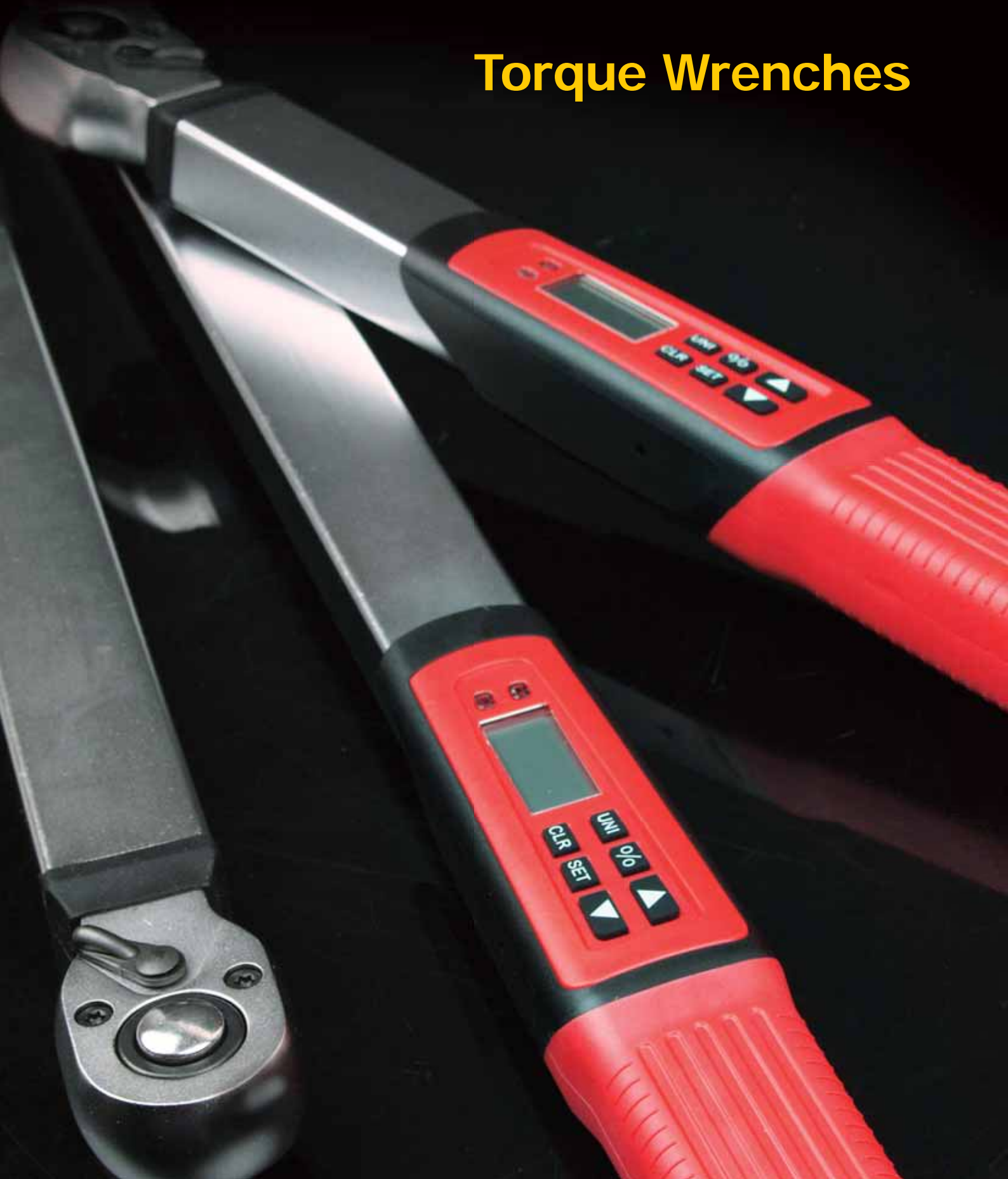

## Digital Torque Wrenches

The new AmPro digital torque wrenches are designed for simple and precise measurement of industrial, automotive, aerospace and many other applications. The torque wrench displays Peak torque on a large LCD panel in Ft/Lb, In/Lb, or Nm scale.

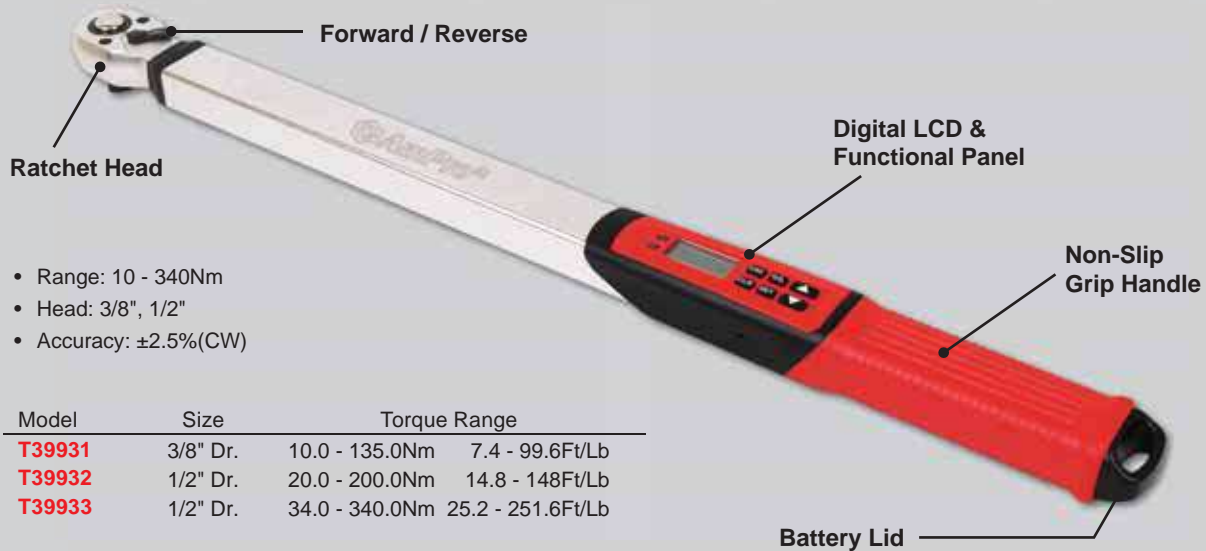

- Range: 10 - 340Nm
- Head: 3/8", 1/2"
- Accuracy:  $\pm 2.5\%$ (CW)

Model	Size	Torque Range	
<b>T39931</b>	3/8" Dr.	10.0 - 135.0Nm	7.4 - 99.6Ft/Lb
<b>T39932</b>	1/2" Dr.	20.0 - 200.0Nm	14.8 - 148Ft/Lb
<b>T39933</b>	1/2" Dr.	34.0 - 340.0Nm	25.2 - 251.6Ft/Lb

10



### Digital Display & Functional Panel

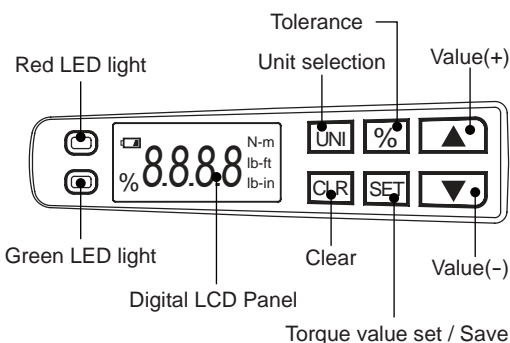

### Power On & Power Off

- Power on: Press any key for 3 seconds.

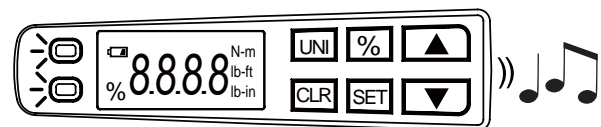

**PS** It may damage the wrench if turn on while applying torque.

- Power off:
  - (1). Automatic: Without applying torque, auto-shutoff after 90 seconds when the display indicates "0".
  - (2). Manual: Without applying torque, press **CLR** button for 5 seconds.



## Digital Torque Wrenches

- Standard functions include torque setting, unit setting, mode setting, and online calibration
- Functions in both clockwise and counter-clockwise directions
- LCD panel shows N-m, ft-lb, in-lb and kg-cm measurements
- Audible and visible torque confirmation by means of buzzer and LED indicator
- Easy setup per application

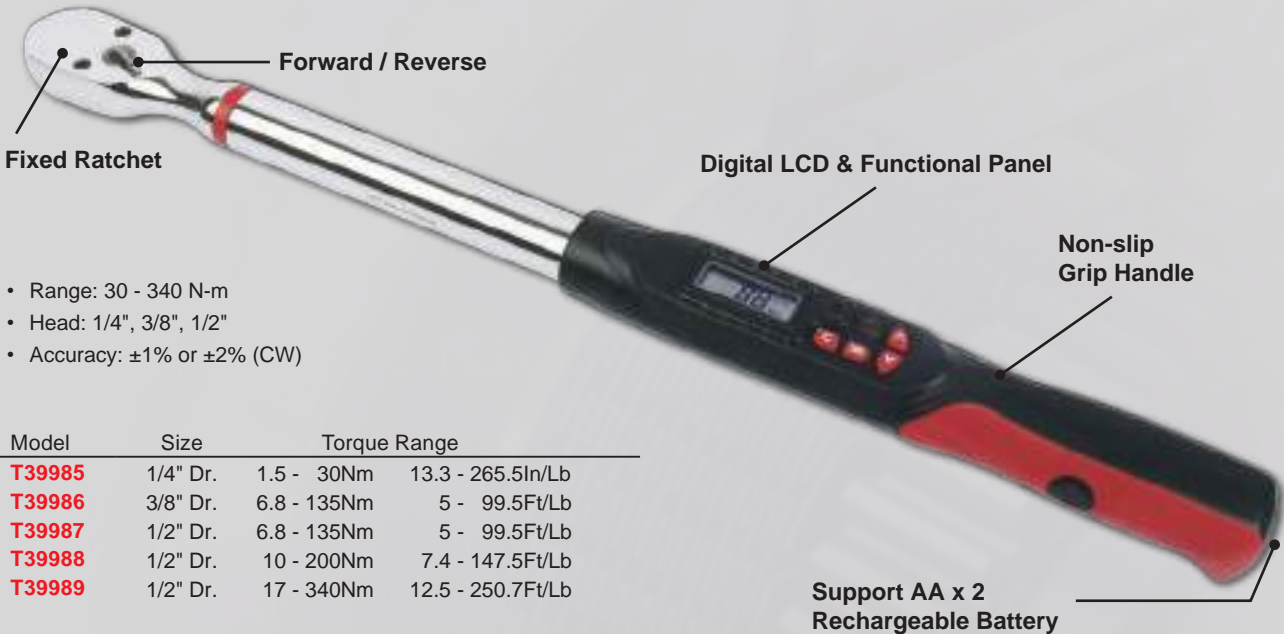

- Range: 30 - 340 N-m
- Head: 1/4", 3/8", 1/2"
- Accuracy:  $\pm 1\%$  or  $\pm 2\%$  (CW)

Model	Size	Torque Range	
<b>T39985</b>	1/4" Dr.	1.5 - 30Nm	13.3 - 265.5In/Lb
<b>T39986</b>	3/8" Dr.	6.8 - 135Nm	5 - 99.5Ft/Lb
<b>T39987</b>	1/2" Dr.	6.8 - 135Nm	5 - 99.5Ft/Lb
<b>T39988</b>	1/2" Dr.	10 - 200Nm	7.4 - 147.5Ft/Lb
<b>T39989</b>	1/2" Dr.	17 - 340Nm	12.5 - 250.7Ft/Lb

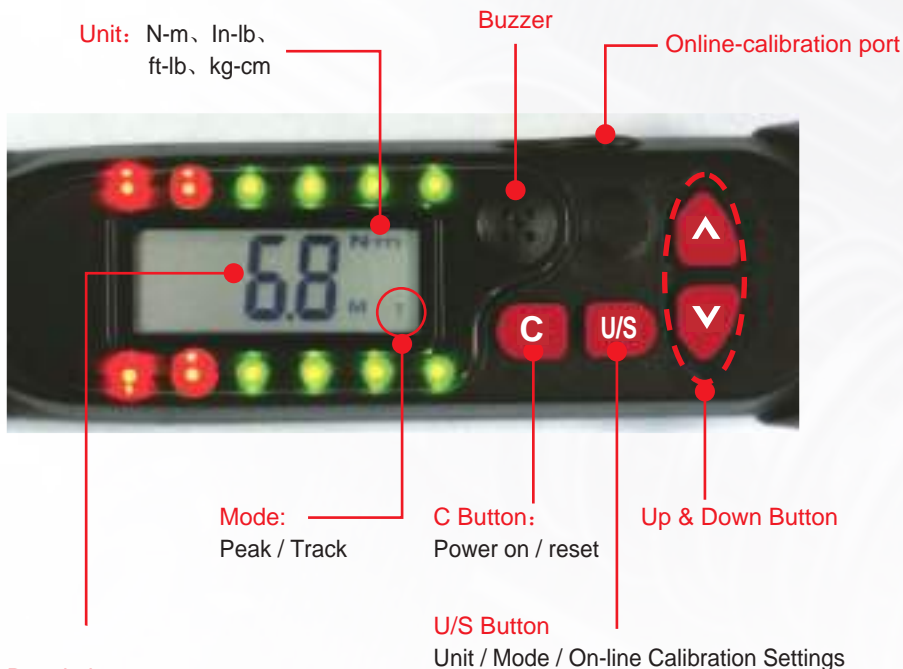
**10**

### 6 or 12 side LED lights

- Green LED lights are on when the torque is approaching the target torque value (a warning signal)
- Red LED lights are on when the torque reaches the target torque value (a stop signal)

### Resolution:

1/4", 3/8":

0.01N-m / 0.1in-lb / 0.01ft-lb / 0.1kg-cm

3/8", 1/2":

0.1N-m / 1in-lb / 0.1ft-lb / 1kg-cm



### Mini Industrial Torque Wrenches

- Industrial quality
- Tolerance of torque  $\pm 3\%$
- Material is aluminum alloy
- Quick release ratchet head
- Quality meets DIN ISO 6789 & ASME B107.14M-1994

Model	Size	Torque Range	Graduation	Length
<b>T39956</b>	1/4" Dr.	3 - 15Nm	0.1	205mm
<b>T39957</b>	1/4" Dr.	5 - 25Nm	0.2	240mm
<b>T39958</b>	3/8" Dr.	3 - 15Nm	0.1	205mm
<b>T39959</b>	3/8" Dr.	5 - 25Nm	0.2	240mm



### Industrial Torque Wrenches

- Industrial quality
- Tolerance of torque  $\pm 3\%$
- Easy torque-adjusting design
- Quick release ratchet head
- Quality meets DIN ISO 6789 & ASME B107.14M-1994

Model	Size	Torque Range
<b>T39945</b>	1/4" Dr.	2 - 10Nm 22.1 - 84.1In/Lb
<b>T39946</b>	1/4" Dr.	4 - 20Nm 39.8 - 172.6In/Lb
<b>T39947</b>	3/8" Dr.	4 - 20Nm 39.8 - 172.6In/Lb
<b>T39948</b>	3/8" Dr.	20 - 100Nm 16.6 - 71.9Ft/Lb
<b>T39949</b>	1/2" Dr.	40 - 200Nm 33.2 - 143.8Ft/Lb
<b>T39950</b>	1/2" Dr.	60 - 340Nm 51.6 - 243.4Ft/Lb
<b>T39951</b>	3/4" Dr.	100 - 600Nm 92 - 424Ft/Lb
<b>T39952</b>	3/4" Dr.	150 - 800Nm 129 - 572Ft/Lb
<b>T39953</b>	3/4" Dr.	200 - 1000Nm 166 - 719Ft/Lb
<b>T39954</b>	1" Dr.	150 - 800Nm 129 - 572Ft/Lb
<b>T39955</b>	1" Dr.	200 - 1000Nm 166 - 719Ft/Lb



### Torque Wrenches

- Chrome Vanadium steel ratchet
- Guaranteed to meet DIN-ISO 6789 and ANSI Spec. B107.14M
- Clicks when torque value is reached

Model	Size	Torque Range
<b>T39901</b>	1/4" Dr.	240In/Lb 24Nm
<b>T39905</b>	3/8" Dr.	960In/Lb 110Nm
<b>T39913</b>	1/2" Dr.	150Ft/Lb 210Nm
<b>T39915</b>	1/2" Dr.	250Ft/Lb 350Nm
<b>T39921</b>	3/4" Dr.	300Ft/Lb 420Nm
<b>T39923</b>	3/4" Dr.	500Ft/Lb 700Nm
<b>T39926</b>	1" Dr.	700Ft/Lb 980Nm



### Dual Scale Beam Torque Wrenches

- Precision calibrated scale with pre-selected torque specifications

Model	Size
<b>T74701</b>	1/2" Dr.



## Industrial Torque Wrenches - Window Clip Type

- Tolerance of torque  $\pm 4\%$
- Ergonomic grip with both SAE & Metric scales
- Quality meets DIN-ISO 6789 and ANSI Spec. B107.14M
- Quick release ratchet head

Model	Size	Torque Range
<b>T39965</b>	1/4" Dr.	36 - 180In/Lb 4 - 20Nm
<b>T39966</b>	3/8" Dr.	15 - 74Ft/Lb 20 - 100Nm
<b>T39967</b>	1/2" Dr.	30 - 148Ft/Lb 40 - 200Nm
<b>T39968</b>	1/2" Dr.	45 - 250Ft/Lb 60 - 340Nm



10

## Flexible Torque Wrenches

- 15-degree flex head in both directions
- Selected scale automatically locked
- Quick release design
- Ergonomic, rugged and no-slip rubber grip
- Quality meets DIN ISO 6789, ASME B107.14M-1994



Model	Size	Torque Range
<b>T39910</b>	3/8" Dr.	20 - 100Nm
<b>T39911</b>	3/8" Dr.	10 - 80Ft/Lb

## Industrial Torque Wrenches

- Industrial quality
- Tolerance of torque  $\pm 3\%$
- Add-on extension metal handle
- Quick release ratchet head
- Quality meets DIN ISO 6789 & ASME B107.14M-1994

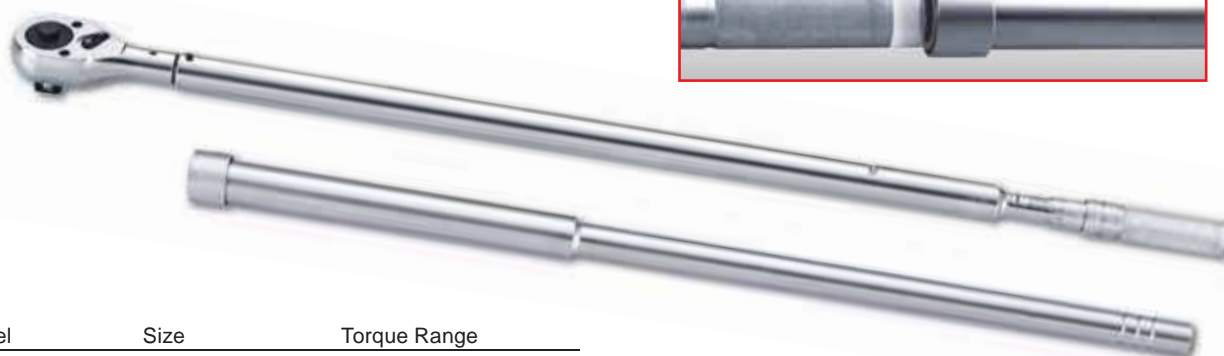

Model	Size	Torque Range
<b>T39938</b>	1 Dr.	300 - 1500Nm 258 - 1070Ft/Lb





### Preset Torque Wrenches

- Ideal for production line where a particular torque is required for repetitive operations
- Reversible preset torque wrench
- Durable and non-slip rubber grip
- Quick release ratchet head
- Audible "Click" when torque is reached

Model	Size	Preset Torque
<b>T39990</b>	1/2" Dr.	88Nm
<b>T39991</b>	1/2" Dr.	110Nm
<b>T39992</b>	1/2" Dr.	135Nm
<b>T39993</b>	1/2" Dr.	163Nm
<b>T39994</b>	1/2" Dr.	190Nm
<b>T39995</b>	1/2" Dr.	65Ft/Lb
<b>T39996</b>	1/2" Dr.	80Ft/Lb
<b>T39997</b>	1/2" Dr.	100Ft/Lb
<b>T39998</b>	1/2" Dr.	120Ft/Lb
<b>T39999</b>	1/2" Dr.	140Ft/Lb



10

### Preset Torque Open-End Wrenches

- Tolerance of torque  $\pm 4\%$
- Chrome Vanadium steel
- Unique head design prevents slipping of the nut while use

Model	Size	Preset Torque
<b>T43400</b>	17mm	16Nm
<b>T43401</b>	17mm	18Nm
<b>T43402</b>	22mm	30Nm
<b>T43403</b>	22mm	42Nm
<b>T43404</b>	24mm	55Nm
<b>T43405</b>	26mm	55Nm
<b>T43406</b>	27mm	65Nm
<b>T43407</b>	29mm	65Nm
<b>T43408</b>	36mm	100Nm



### Interchangeable Torque Wrenches



- Fits standard insert head
- Quick-release button for easy removal of the insert head
- Ergonomic and cushioned rubber grip
- Fast and accurate torque settings



Model	Dimension (mm)	Torque Range
<b>T39972</b>	9mm x 12mm	10 - 60Nm 9.2 - 42.4Ft/Lb
<b>T39973</b>	14mm x 18mm	20 - 100Nm 16.6 - 71.9Ft/Lb
<b>T39974</b>	14mm x 18mm	40 - 200Nm 33.2 - 143.8Ft/Lb



## Insert Tools for Interchangeable Torque Wrenches



## Ring Insert Tools

- Chrome Vanadium steel
- Fits for interchangeable torque wrenches
- Uses with T39972, T39973, T39974



Model	Size	■ (mm)
T43300	8mm	9mm x 12mm
T43301	10mm	9mm x 12mm
T43302	12mm	9mm x 12mm
T43303	14mm	9mm x 12mm
T43304	15mm	9mm x 12mm
T43305	17mm	9mm x 12mm
T43306	18mm	9mm x 12mm
T43307	19mm	9mm x 12mm
T43308	22mm	9mm x 12mm
T43309	14mm	14mm x 18mm
T43310	17mm	14mm x 18mm
T43311	19mm	14mm x 18mm
T43312	22mm	14mm x 18mm
T43313	24mm	14mm x 18mm
T43314	27mm	14mm x 18mm
T43315	30mm	14mm x 18mm
T43316	32mm	14mm x 18mm
T43317	36mm	14mm x 18mm

## Open Ended Insert Tools

- Chrome Vanadium steel
- Fits interchangeable torque wrenches
- Uses with T39972, T39973, T39974



Model	Size	■ (mm)
T43000	7mm	9mm x 12mm
T43001	10mm	9mm x 12mm
T43002	11mm	9mm x 12mm
T43003	12mm	9mm x 12mm
T43004	13mm	9mm x 12mm
T43005	14mm	9mm x 12mm
T43006	15mm	9mm x 12mm
T43007	16mm	9mm x 12mm
T43008	17mm	9mm x 12mm
T43009	18mm	9mm x 12mm
T43010	19mm	9mm x 12mm
T43011	13mm	14mm x 18mm
T43012	14mm	14mm x 18mm
T43013	15mm	14mm x 18mm
T43014	17mm	14mm x 18mm
T43015	18mm	14mm x 18mm
T43016	19mm	14mm x 18mm
T43017	21mm	14mm x 18mm
T43018	22mm	14mm x 18mm
T43019	24mm	14mm x 18mm
T43020	27mm	14mm x 18mm
T43021	30mm	14mm x 18mm
T43022	32mm	14mm x 18mm
T43023	34mm	14mm x 18mm
T43024	36mm	14mm x 18mm
T43025	38mm	14mm x 18mm
T43026	41mm	14mm x 18mm

## Ratchet Insert Tools (Push Type)

- Chrome Vanadium steel
- Fits interchangeable torque wrenches
- Uses with T39972, T39973, T39974



Model	Size	■ (mm)
T43080	1/4"	9mm x 12mm
T43081	3/8"	9mm x 12mm
T43082	3/8"	14mm x 18mm
T43083	1/2"	14mm x 18mm



### T39976 8pc Interchangeable Torque Wrench Set

- Contents:
  - 1 - Torque handle (10 - 60Nm)
  - 1 - Insert geared ratchet head (3/8" Dr.)
  - 3 - Open ended insert tools: 10, 13, 17mm
  - 3 - Ring insert tools: 10, 13, 17mm



### T39977 11pc Interchangeable Torque Wrench Set

- Contents:
  - 1 - Torque handle (40 - 200Nm)
  - 1 - Insert geared ratchet head (1/2" Dr.)
  - 9 - Open ended insert tools: 13, 14, 15, 17, 19, 22, 24, 27, 30mm

10



### Torque Screwdrivers

- Tolerance of torque  $\pm 5\%$
- 6.35mm (1/4") Hex drive for bit
- Automatic adjustable knob design
- Easy-to-read laser scale
- Ergonomic rubber grip



Model	Size	Torque Range
T39980	6.35mm (1/4") Hex Drive	10 - 120cNm
T39981	6.35mm (1/4") Hex Drive	1 - 6Nm
T39982	6.35mm (1/4") Hex Drive	3 - 15In/Lb
T39983	6.35mm (1/4") Hex Drive	10 - 50In/Lb



### Preset Torque Screwdriver

- Tolerance of torque  $\pm 5\%$
- 6.35mm (1/4") Hex drive for bit
- Ergonomic rubber grip
- Audible "Click" when torque reached
- The preset torque screwdriver are apply to the production line and where needs a particular torque for repetitive operation
- Quality meets DIN ISO 6789 & ASME B107.14M-1994

Model	Size	Torque Range
T39984	1/4" Dr.	0.2 - 1.6Nm





## Torque Multipliers (Hex Type)

- Tolerance of torque  $\pm 5\%$
- Precision geared mechanism applies high torque output with low input
- Heavy duty construction reduces maintenance procedures
- Torque Multiplier works in both directions
- To tighten/loosen nuts and bolts
- Great for removing over-tightened and seized nuts even when impact tools fail
- Ideal for use in large automotive shops, mining, heavy-duty engineering and remote locations where there is no access to air or electric power



Model	Input Sq.	Output Sq.	Gear Ratio	Torque Ratio	Max. Input Torque	Max. Output Torque
<b>T39960</b>	1/2" Dr.	3/4" Dr.	1:4	1:3.3	303Nm	1000Nm
<b>T39961</b>	1/2" Dr.	3/4" Dr.	1:9	1:6.5	231Nm	1500Nm
<b>T39962</b>	1/2" Dr.	1" Dr.	1:12	1:9	222Nm	2000Nm
<b>T39963</b>	1/2" Dr.	1" Dr.	1:16	1:12	208Nm	2500Nm
<b>T39964</b>	3/4" Dr.	1" Dr.	1:4	1:3.3	758Nm	2500Nm

10

**T39969** 5pc 1/2" (F) x 3/4" (M) 1500 Nm Torque Multiplier Set (Hex Type)

**T39970** 5pc 1/2" (F) x 1" (M) 2500 Nm Torque Multiplier Set (Hex Type)

**T39971** 5pc 3/4" (F) x 1" (M) 2500 Nm Torque Multiplier Set (Hex Type)

- Contents:
  - 1 - Torque Multiplier
  - 1 - 380mm Reaction Bar
  - 1 - 90° Reaction Base
  - 1 - 90° Reaction Bar
  - 1 - Break-away Safety Adaptor



 **Warning:** Do not use with Impact Wrench.



### T74705 Torque Angle Gauge

- Measures angle of rotation after pre-torque load in torque-angle applications
- 360 degree scale clearly marked in 2 degree increments & in intervals of 10 & 30
- Easily zero the gauge by turning housing for next application



10

### T39900 Professional Torque Calibration Machine

- Quality meets DIN ISO 6789 and ASME B107.14M-1994
- Metrological accuracy ensuring reliability of test results
- Easy to operate
- Keeping the torque tester horizontally to remain within the tolerances specified by standard

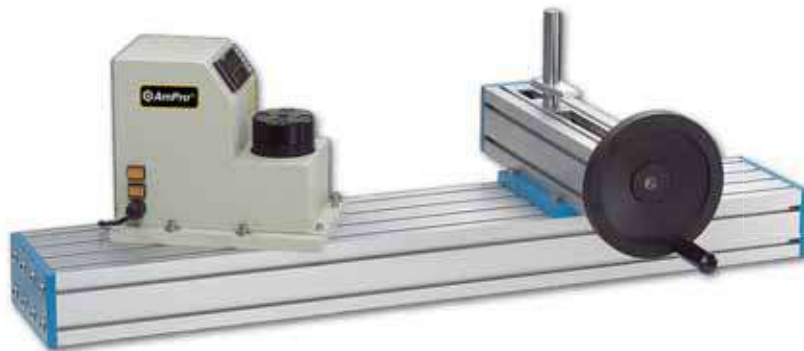

Calibration	-500NM ~ 500NM
Resolution	1%
Display	-19999 ~ 99999
Accuracy	1%
Units of Measurement	KG-M / M-LB / NM / FT-LB
Reset Holding Time	0. ~ 9.9 sec.
Operating Temperature Range	+5°C ~ +50°C
Storage Temperature Range	0°C ~ +50°C

Maximum operating humidity	25 ~ 85% RH
Power Supply	90 ~ 260V AC @50-60 Hz
Power Consumption	1A
Power Cable	1700mm
Base Material / Finish	Aluminum Alloy / Silver Paint
Dimension	113 (L) x 20 (W) x 35 (H)cm
Weight	45.7 Kg



# Hex & Star Wrenches

(SAE / Metric / Star)





**T22984**
**T22983**
**T22985**

### Magnetic Wrench Sets

- Magnetic tip for secure hold
- Color-coded for quick identification
- Industrial S2 alloy steel
- Flip-open style key holder
- Mirror finish, chrome plated ensures high corrosion protection

**T22984 9pc Magnetic Ball Point Hex Wrench Set**  
1.5, 2, 2.5, 3, 4, 5, 6, 8, 10mm

**T22983 9pc Magnetic Ball Point Hex Wrench Set**  
1/16", 5/64", 3/32", 1/8", 5/32", 3/16", 1/4", 5/16", 3/8"

**T22985 9pc Magnetic Tamper-Proof Star Wrench Set**  
T10, T15, T20, T25, T27, T30, T40, T45, T50

**T23000 9pc Magnetic Extra Long Ball Point Hex Wrench Set**  
1.5, 2, 2.5, 3, 4, 5, 6, 8, 10mm

**T23001 9pc Magnetic Extra Long Ball Point Hex Wrench Set**  
1/16", 5/64", 3/32", 1/8", 5/32", 3/16", 1/4", 5/16", 3/8"

**T23002 9pc Magnetic Extra Long Tamper-Proof Star Wrench Set**  
T10, T15, T20, T25, T27, T30, T40, T45, T50

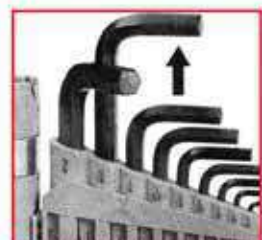
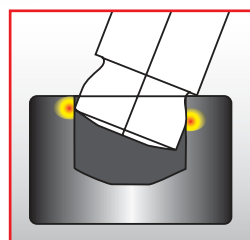
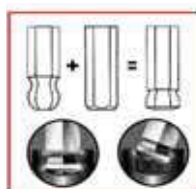
**Turball Head Design**

### "Turball" Long Arm Ball Point Hex Wrench Sets

- Wobble action and standard all-in-one
- Long arm for maximum torque leverage
- Chrome Vanadium steel

**T22890 9pc "Turball" Long Arm Ball Point Hex Wrench Set**  
1.5, 2, 2.5, 3, 4, 5, 6, 8, 10mm

**T22891 9pc "Turball" Long Arm Ball Point Hex Wrench Set**  
1/16", 5/64", 3/32", 1/8", 5/32", 3/16", 1/4", 5/16", 3/8"

## Hex & Star Wrench Sets

- Chrome Vanadium steel
- Bonus blow case for convenient storage

### T22946 18pc Hex Wrench Set (SAE & Metric)

9 - SAE: 1/16", 5/64", 3/32", 1/8", 5/32", 3/16", 1/4", 5/16", 3/8"

9 - Metric: 1.5, 2, 2.5, 3, 4, 5, 6, 8, 10mm

### T22947 18pc Hex & Star Wrench Set

9 - Hex: 1.5, 2, 2.5, 3, 4, 5, 6, 8, 10mm

9 - Star: T10, T15, T20, T25, T27, T30, T40, T45, T50



## Long Ball Point Hex & Star Wrench Sets

- Ball point end for speed & convenience
- Long arm maximum leverage & torque
- Chrome Vanadium steel
- Bonus blow case for convenient storage

### T22948 18pc Long Ball Point Hex Wrench Set (SAE & Metric)

9 - SAE: 1/16", 5/64", 3/32", 1/8", 5/32", 3/16", 1/4", 5/16", 3/8"

9 - Metric: 1.5, 2, 2.5, 3, 4, 5, 6, 8, 10mm

### T22949 18pc Extra Long Hex and Star Wrench Set

9 - Hex: 1.5, 2, 2.5, 3, 4, 5, 6, 8, 10mm

9 - Star: T10, T15, T20, T25, T27, T30, T40, T45, T50



11

### T22935 3-Way Multi-handle Ball Point Hex Wrench Set (SAE & Metric)

- Flip-open style holder.
  - Ball point end for speed & convenience.
  - Long arm maximum leverage torque.
  - Contents: (Chrome Vanadium steel)
- 13 - SAE:  
0.05, 1/16", 5/64", 3/32", 7/64", 1/8", 9/64", 5/32", 3/16", 7/32", 1/4", 5/16", 3/8"
- 9 - Metric Sizes:  
1.5, 2, 2.5, 3, 4, 5, 6, 8, 10mm





### Wrench Sets

- S2 alloy steel for strength and durability
- Superior grade plastic holder
- Satin finish, chrome plated



T23010



T23011

### T23010 13pc Hex Wrench Set

1.5, 2, 2.5, 3, 4, 4.5, 5, 5.5, 6, 7, 8, 9, 10mm

### T23011 12pc Hex Wrench Set

1/16", 5/64", 3/32", 7/64", 1/8", 9/64, 5/32", 3/16", 7/32", 1/4", 5/16", 3/8"

11

### Long Arm Wrench Set

### T23012 9pc Long Arm Ball Point Hex Wrench Set

1.5, 2, 2.5, 3, 4, 5, 6, 8, 10mm

### T23013 9pc Long Arm Ball Point Hex Wrench Set

1/16", 5/64", 3/32", 1/8", 5/32", 3/16", 1/4", 5/16", 3/8"

### T23014 9pc Long Arm Star Wrench Set

T10, T15, T20, T25, T27, T30, T40, T45, T50

### T23015 9pc Long Arm Tamper-Proof Star Wrench Set

T10, T15, T20, T25, T27, T30, T40, T45, T50

### T23016 18pc Long Arm Ball Point Hex Wrench Set (SAE & Metric)

9 - SAE: 1/16", 5/64", 3/32", 1/8", 5/32", 3/16", 1/4", 5/16", 3/8"

9 - Metric: 1.5, 2, 2.5, 3, 4, 5, 6, 8, 10mm

### T23017 18pc Long Arm Ball Point Hex & Tamper-Proof Star Wrench Set

9 - Metric: 1.5, 2, 2.5, 3, 4, 5, 6, 8, 10mm

9 - Tamper-Proof Star:

T10, T15, T20, T25, T27, T30, T40, T45, T50



T23012



T23013



T23014



T23015



T23016



T23017





## Extra Long Ball Point Hex Wrench Sets

- Chrome Vanadium steel for strength and durability
- Superior grade plastic holder
- Satin finish, chrome plated

### T23020 10pc Extra Long Ball Point Hex Wrench Set

1.27, 1.5, 2, 2.5, 3, 4, 5, 6, 8, 10mm

### T23021 13pc Extra Long Ball Point Hex Wrench Set

0.05", 1/16", 5/64", 3/32", 7/64", 1/8", 9/64", 5/32", 3/16", 7/32", 1/4", 5/16", 3/8"



T23020

T23021

## Ball Point Hex Wrench Sets

- Chrome Vanadium steel for strength and durability
- Superior grade plastic holder
- Satin finish, chrome plated

### T23023 25pc Ball Point Hex Wrench Set (Metric & SAE)

12 - Metric:

1.27, 1.5, 2, 2.5, 3, 4, 5, 6, 7, 8, 9, 10mm

13 - SAE:

0.05", 1/16", 5/64", 3/32", 7/64", 1/8", 9/64", 5/32", 3/16", 7/32", 1/4", 5/16", 3/8"



## Folding Wrench Sets

- Chrome Vanadium steel
- Mirror finish, chrome plated

### T23025 8pc Folding Ball Point Hex Wrench Set

1.5, 2, 2.5, 3, 4, 5, 6, 8mm

### T23026 9pc Folding Ball Point Hex Wrench Set

5/64", 3/32", 7/64", 1/8", 9/64", 5/32", 3/16", 7/32", 1/4"

### T23027 8pc Folding Start Wrench Set

T9, T10, T15, T20, T25, T27, T30, T40



T23025

T23027

T23026



T22924 / T22925

T22926

T22927



T22932

T22933



### "L" Type Wrench Sets

- Chrome Vanadium steel
- Satin finish
- Easy access, flip-open style key holder

#### T22924 9pc Star Wrench Set

T10, T15, T20, T25, T27, T30, T40, T45, T50

#### T22925 9pc Tamper-Proof Star Wrench Set

T10, T15, T20, T25, T27, T30, T40, T45, T50

#### T22928 9pc Hex Wrench Set

1/16", 5/64", 3/32", 1/8", 5/32", 3/16", 1/4", 5/16", 3/8"

#### T22926 9pc Hex Wrench Set

1.5, 2, 2.5, 3, 4, 5, 6, 8, 10mm

#### T22927 9pc Ball Point Hex Wrench Set

1.5, 2, 2.5, 3, 4, 5, 6, 8, 10mm

#### T22932 9pc Long Hex Wrench Set

1.5, 2, 2.5, 3, 4, 5, 6, 8, 10mm

#### T22933 9pc Long Ball Point Hex Wrench Set

1.5, 2, 2.5, 3, 4, 5, 6, 8, 10mm

#### T22929 9pc Long Ball Point Hex Wrench Set

1/16", 5/64", 3/32", 1/8", 5/32", 3/16", 1/4", 5/16", 3/8"

#### T22934 9pc Long Star Wrench Set

T10, T15, T20, T25, T27, T30, T40, T45, T50

### Hex Wrench Sets

- Chrome Vanadium steel
- Convenient storage holder

#### T73000 12pc Hex Wrench Set

0.05", 1/16", 5/64", 3/32", 7/64", 1/8", 9/64", 5/32", 3/16", 7/32", 1/4", 5/16"

#### T73001 9pc Hex Wrench Set

1.5, 2, 2.5, 3, 4, 5, 6, 8, 10mm

#### T73003 12pc Long Arm Hex Wrench Set

0.05", 1/16", 5/64", 3/32", 7/64", 1/8", 9/64", 5/32", 3/16", 7/32", 1/4", 5/16"

#### T73004 9pc Long Arm Hex Wrench Set

1.5, 2, 2.5, 3, 4, 5, 6, 8, 10mm

### Long Arm Hex Wrench Sets

- Chrome Vanadium steel
- Extra long shanks with convenient storage holder

#### T73010 12pc Long Arm Hex Wrench Set

0.05", 1/16", 5/64", 3/32", 7/64", 1/8", 9/64", 5/32", 3/16", 7/32", 1/4", 5/16"

#### T73012 9pc Long Arm Hex Wrench Set

1.5, 2, 2.5, 3, 4, 5, 6, 8, 10mm

#### T73040 12pc Long Arm Hex Wrench w/ Ball End

0.05", 1/16", 5/64", 3/32", 7/64", 1/8", 9/64", 5/32", 3/16", 7/32", 1/4", 5/16"

#### T73041 9pc Long Arm Hex Wrench w/ Ball End

1.5, 2, 2.5, 3, 4, 5, 6, 8, 10mm



### Hex Wrench Sets

- Chrome Vanadium steel
- Great for hard-to-reach applications
- Includes convenient folding storage holder

**T73006 7pc Long Ball Point Speed Hex Wrench Set**  
2.5, 3, 4, 5, 6, 8, 10mm

**T73007 7pc Long Ball Point Speed Hex Wrench Set**  
3/32", 1/8", 5/32", 3/16", 1/4", 5/16", 3/8"

**T73014 11pc Hex Wrench Set**  
0.05", 1/16", 5/64", 3/32", 1/8", 5/32", 3/16", 7/32", 1/4", 5/16", 3/8"

**T73016 10pc Hex Wrench Set**  
1.27, 1.5, 2, 2.5, 3, 4, 5, 6, 8, 10mm



### Industrial Wrench Sets

- Industrial S2 Alloy steel
- Extra long shanks w/ convenient storage holder

**T22955 9pc Extra Long Ball Point Hex Wrench Set**  
1.5, 2, 2.5, 3, 4, 5, 6, 8, 10mm

**T22956 9pc Extra Long Ball Point Hex Wrench Set**  
1/16", 5/64", 3/32", 1/8", 5/32", 3/16", 1/4", 5/16", 3/8"

**T22960 9pc Extra Long Star Wrench Set**  
T10, T15, T20, T25, T27, T30, T40, T45, T50

**T22962 9pc Extra Long Tamper-Proof Star Wrench Set**  
T10, T15, T20, T25, T27, T30, T40, T45, T50



### Folding Wrench Sets

- Chrome Vanadium steel
- Cushioned grip handle for comfort and sturdy hold

**T22990 8pc Folding Star Wrench Set**  
T8, T10, T15, T20, T25, T27, T30, T40

**T22991 8pc Folding Tamper-Proof Star Wrench Set**  
T8, T10, T15, T20, T25, T27, T30, T40

**T22993 7pc Folding Hex Wrench Set**  
1.5, 2, 2.5, 3, 4, 5, 6mm

**T22994 7pc Folding Hex Wrench Set**  
2.5, 3, 4, 5, 6, 8, 10mm

**T22997 7pc Folding Hex Wrench Set**  
1/16", 5/64", 3/32", 1/8", 5/32", 3/16", 7/32"

**T22998 7pc Folding Hex Wrench Set**  
3/32", 1/8", 5/32", 3/16", 1/4", 5/16", 3/8"







### Folding Wrench Sets

- Chrome Vanadium steel
- Satin finish

#### T22940 8pc Folding Star Wrench Set

T9, T10, T15, T20, T25, T27, T30, T40

#### T22941 8pc Tamper-Proof Star Wrench Set

T9, T10, T15, T20, T25, T27, T30, T40

#### T22942 8pc Hex Wrench Set

2.5, 3, 4, 5, 6, 7, 8, 10mm

#### T22972 7pc Folding Star Wrench Set (Black Oxide Finish)

T10, T15, T20, T25, T27, T30, T40

#### T22981 16pc Hex & Star Wrench Set

- Hex: 1.5, 2, 2.5, 3, 4, 5, 6, 8mm
- Star: T9, T10, T15, T20, T25, T27, T30, T40



#### T22967 18pc Long Arm Wrench & Star Bit Set

- S2 alloy steel
- Contents:
  - 7 - Hex Wrench: 3, 4, 5, 6, 7, 8, 10mm
  - 1 - 8mm Adaptor
  - 1 - Handle
  - 9 - 8mm Star Bits (30mm):
    - T10, T15, T25, T27, T27, T30, T40, T45, T50



#### T22896 7pc "Turball" Hex Wrench Set

2.5, 3, 4, 5, 6, 8, 10mm

#### T22897 7pc "Turball" Hex Wrench Set

1.5, 2, 2.5, 3, 4, 5, 6mm



#### T22970 6pc Industrial Star Driver Set

- Chrome Vanadium steel
- Black oxide finish resists corrosion
- T40, T45, T47, T50, T55, T60





## Jumbo Size Wrenches

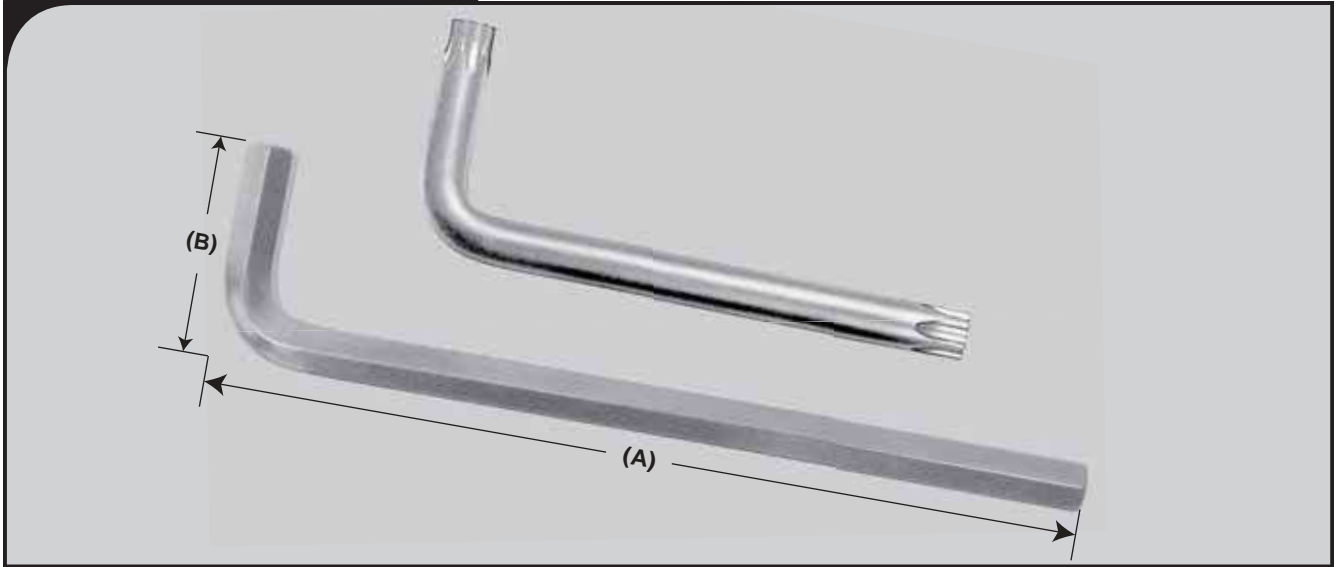

### Jumbo Hex Wrenches

Model	Size	(A)	(B)
T23050	12.0mm	125mm	45mm
T23051	14.0mm	140mm	56mm
T23053	17.0mm	160mm	63mm
T23054	19.0mm	180mm	70mm
T23055	22.0mm	200mm	80mm
T23056	24.0mm	224mm	90mm
T23057	27.0mm	250mm	100mm
T23058	30.0mm	280mm	112mm
T23059	32.0mm	315mm	125mm
T23060	36.0mm	355mm	140mm
T23061	41.0mm	401mm	153mm
T23062	42.0mm	407mm	157mm
T23063	46.0mm	444mm	166mm
T23064	50.0mm	474mm	184mm
T23065	55.0mm	520mm	194mm

\* T23057 ~ T23065 Black Oxide Finish.

### Jumbo-Long Hex Wrenches

Model	Size	(A)	(B)
T23070	12.0mm	207mm	45mm
T23071	14.0mm	230mm	56mm
T23072	17.0mm	250mm	61mm
T23073	19.0mm	280mm	70mm

### Jumbo Star Wrenches

Model	Size	(A)	(B)
T23075	T55	123mm	45mm

### Jumbo-Long Star Wrenches

Model	Size	(A)	(B)
T23080	T50	152mm	32mm
T23081	T55	171mm	35mm
T23082	T60	190mm	38mm
T23083	T70	209mm	41mm

### T23090 6pc Jumbo Hex Wrench Set

8, 10, 12, 14, 17, 19mm



### T23093 4pc Jumbo-Long Hex Wrench Set

12, 14, 17, 19mm





## T-Handle Tamper-Proof Star and Star Wrenches

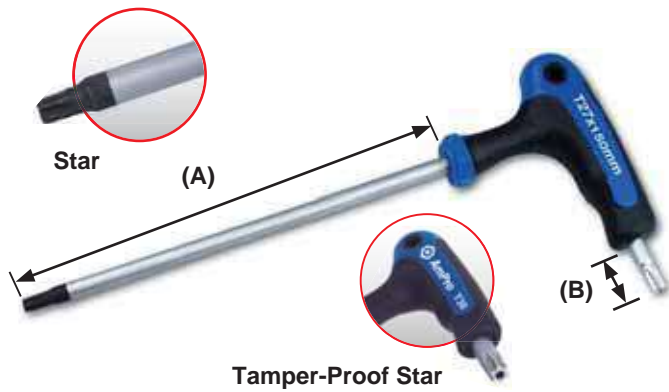

Model	Size	(A)	(B)
T22802	T9	100mm	15mm
T22803	T10	100mm	15mm
T22804	T15	100mm	15mm
T22805	T20	100mm	15mm
T22806	T25	150mm	17mm
T22807	T27	150mm	17mm
T22808	T30	150mm	17mm
T22809	T40	200mm	20mm
T22810	T45	200mm	20mm
T22811	T50	200mm	22mm
T22812	T55	200mm	22mm

## T-Handle Ball Point and Hex Wrenches

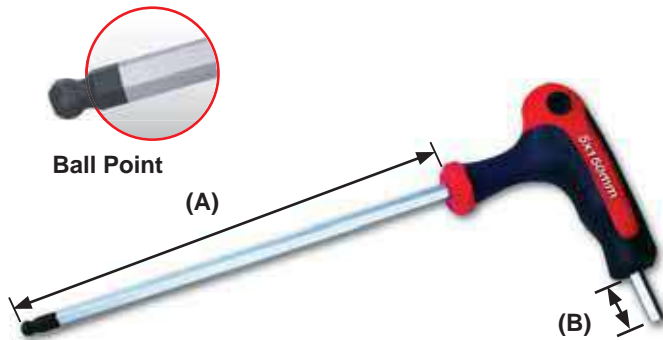

Model	Size	(A)	(B)
T22815	2mm	100mm	15mm
T22816	2.5mm	100mm	15mm
T22817	3mm	100mm	15mm
T22819	4mm	150mm	17mm
T22821	5mm	150mm	17mm
T22822	5.5mm	150mm	17mm
T22823	6mm	150mm	17mm
T22827	7mm	200mm	20mm
T22824	8mm	200mm	20mm
T22825	10mm	200mm	20mm
T22826	12mm	200mm	20mm
T22830	5/64"	100mm	15mm
T22831	3/32"	100mm	15mm
T22833	1/8"	100mm	15mm
T22835	5/32"	150mm	17mm
T22836	3/16"	150mm	17mm
T22838	1/4"	150mm	17mm
T22839	5/16"	200mm	20mm
T22840	3/8"	200mm	20mm
T22841	1/2"	200mm	20mm



### T22900 10pc T-Handle Tamper-Proof Star and Star Wrench Set

T10, T15, T20, T25, T27, T30, T40, T45, T50, T55

### T22901 10pc T-Handle Ball Point and Hex Wrench Set

2, 2.5, 3, 4, 5, 5.5, 6, 8, 10, 12mm

### T22902 10pc T-Handle Ball Point and Hex Wrench Set

5/64", 3/32", 1/8", 5/32", 3/16", 7/32", 1/4", 5/16", 3/8", 1/2"





# Professional Screwdrivers

Overwhelming Selections

Quality and Power





## "Power Grip" Screwdrivers

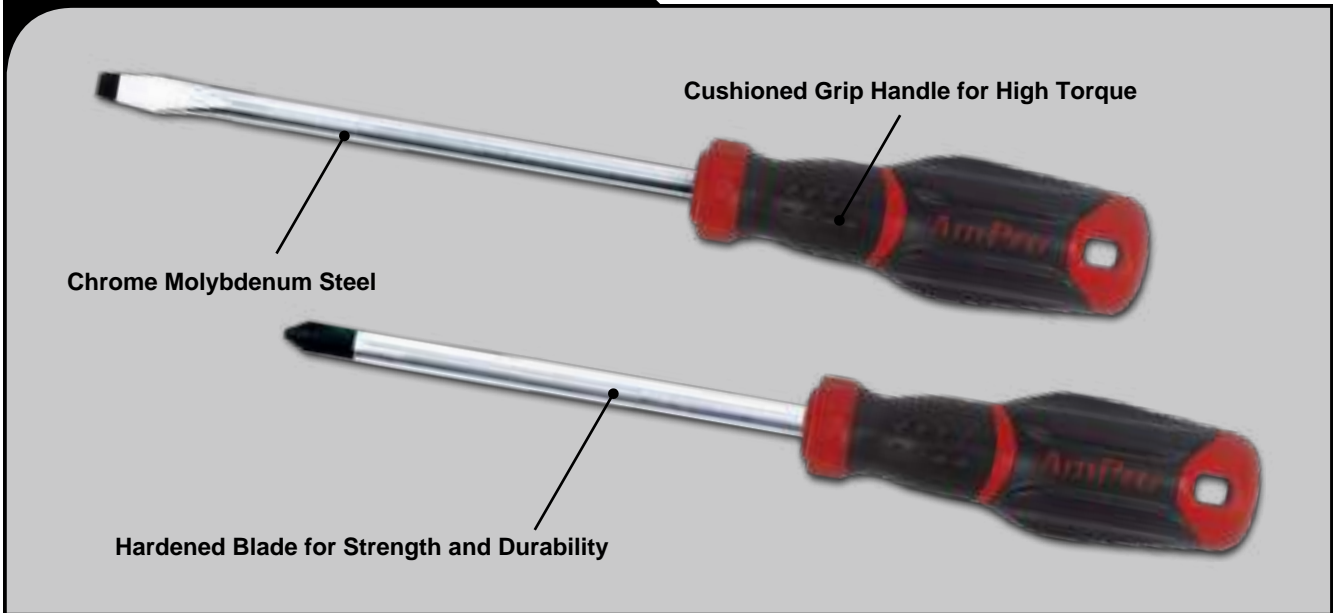

12

### Slotted Screwdrivers:

Model	Blade Diameter x Length
T32700	3.0mm x 60mm (1/8" x 2-3/8")
T32704	4.0mm x 80mm (5/32" x 3-1/8")
T32708	5.5mm x 80mm (7/32" x 3-1/8")
T32709	5.5mm x 100mm (7/32" x 4")
T32710	5.5mm x 125mm (7/32" x 5")
T32715	6.5mm x 38mm (1/4" x 1-1/2")
T32716	6.5mm x 100mm (1/4" x 4")
T32717	6.5mm x 150mm (1/4" x 6")
T32718	8mm x 150mm (5/16" x 6")
T32719	8mm x 200mm (5/16" x 8")

### Phillips Screwdrivers:

Model	Blade Diameter x Length
T32731	#0 x 60mm (#0 x 2-3/8")
T32735	#1 x 80mm (#1 x 3-1/8")
T32736	#1 x 100mm (#1 x 4")
T32738	#1 x 150mm (#1 x 6")
T32740	#2 x 38mm (#2 x 1-1/2")
T32741	#2 x 100mm (#2 x 4")
T32742	#2 x 150mm (#2 x 6")
T32744	#3 x 150mm (#3 x 6")
T32748	#3 x 200mm (#3 x 8")

### Star Screwdrivers:

Model	Blade Diameter x Length
T32760	T10 x 80mm (T10 x 3-1/8")
T32761	T15 x 80mm (T15 x 3-1/8")
T32762	T20 x 100mm (T20 x 4")
T32763	T25 x 100mm (T25 x 4")
T32764	T27 x 100mm (T27 x 4")
T32765	T30 x 125mm (T30 x 5")

### Pozi Screwdrivers:

Model	Blade Diameter x Length
T32766	#0 x 60mm (#0 x 2-3/8")
T32767	#1 x 80mm (#1 x 3-1/8")
T32768	#2 x 100mm (#2 x 4")
T32770	#3 x 150mm (#3 x 6")



**T32790 5pc "Power Grip" Screwdriver Set**

- Contents: (Chrome Molybdenum steel)
  - 3 - Slotted:
    - 4.0mm x 80mm (5/32" x 3-1/8")
    - 5.5mm x 125mm (7/32" x 5")
    - 6.5mm x 150mm (1/4" x 6")
  - 2 - Phillips:
    - #1 x 80mm (#1 x 3-1/8"), #2 x 100mm (#2 x 4")

**T32791 7pc "Power Grip" Screwdriver Set**

- Contents: (Chrome Molybdenum steel)
  - 4 - Slotted:
    - 4.0mm x 80mm (5/32" x 3-1/8")
    - 5.5mm x 125mm (7/32" x 5")
    - 6.5mm x 150mm (1/4" x 6")
    - 8.0mm x 200mm (5/16" x 8")
  - 3 - Phillips:
    - #1 x 80mm (#1 x 3-1/8"), #2 x 100mm (#2 x 4")
    - #3 x 150mm (#3 x 6")

**T32793 8pc "Power Grip" Screwdriver Set**

- Contents: (Chrome Molybdenum steel)
  - 4 - Slotted:
    - 4.0mm x 80mm (5/32" x 3-1/8")
    - 5.5mm x 125mm (7/32" x 5")
    - 6.5mm x 38mm (1/4" x 1-1/2")
    - 6.5mm x 150mm (1/4" x 6")
  - 4 - Phillips:
    - #1 x 80mm (#1 x 3-1/8"), #2 x 38mm (#2 x 1-1/2")
    - #2 x 100mm (#2 x 4"), #3 x 150mm (#3 x 6")

**T32799 6pc "Power Grip" Star Screwdriver Set**

- Contents: (Chrome Molybdenum steel)
  - 6 - Star:
    - T10, T15, T20, T25, T27, T30







### T32796 5pc "Power Grip" Screwdriver Set

- Contents: (Chrome Molybdenum steel)
  - 3 - Slotted:
    - 4.0mm x 80mm (5/32" x 3-1/8")
    - 5.5mm x 125mm (7/32" x 5")
    - 6.5mm x 150mm (1/4" x 6")
  - 2 - Pozi:
    - #1 x 80mm (#1 x 3-1/8"), #2 x 100mm (#2 x 4")



### T32792 7pc "Power Grip" Screwdriver Set

- Contents: (Chrome Molybdenum steel)
  - 4 - Slotted:
    - 4.0mm x 80mm (5/32" x 3-1/8")
    - 5.5mm x 125mm (7/32" x 5")
    - 6.5mm x 150mm (1/4" x 6")
    - 8.0mm x 200mm (5/16" x 8")
  - 3 - Pozi:
    - #1 x 80mm (#1 x 3-1/8")
    - #2 x 100mm (#2 x 4")
    - #3 x 150mm (#3 x 6")

## "Super Grip" Screwdrivers

"Super Grip" features a large ergonomic cushioned handle that prevents slippage even with oily hands. The dotted design on the handle ensures a slip-resistant grip that allows for easy, comfortable, and accurate driving.



### Slotted Screwdrivers:

Model	Blade Diameter x Length
T32000	3.0mm x 60mm (1/8" x 2-3/8")
T32001	4.0mm x 80mm (5/32" x 3-1/8")
T32004	5.5mm x 80mm (7/32" x 3-1/8")
T32005	5.5mm x 100mm (7/32" x 4")
T32006	5.5mm x 125mm (7/32" x 5")
T32009	6.5mm x 38mm (1/4" x 1-1/2")
T32012	6.5mm x 100mm (1/4" x 4")
T32014	6.5mm x 150mm (1/4" x 6")
T32016	8.0mm x 150mm (5/16" x 6")
T32017	8.0mm x 200mm (5/16" x 8")

### Phillips Screwdrivers:

Model	Blade Diameter x Length
T32020	#0 x 60mm (#0 x 2-3/8")
T32021	#1 x 80mm (#1 x 3-1/8")
T32022	#1 x 100mm (#1 x 4")
T32023	#1 x 150mm (#1 x 6")
T32025	#2 x 100mm (#2 x 4")
T32026	#2 x 150mm (#2 x 6")
T32027	#2 x 125mm (#2 x 5")
T32028	#2 x 200mm (#2 x 8")
T32029	#2 x 38mm (#2 x 1-1/2")
T32033	#3 x 125mm (#3 x 5")
T32036	#3 x 150mm (#3 x 6")

### Pozi Screwdrivers:

Model	Blade Diameter x Length
T32039	#0 x 60mm (#0 x 2-3/8")
T32040	#1 x 80mm (#1 x 3-1/8")
T32041	#2 x 100mm (#2 x 4")
T32042	#3 x 150mm (#3 x 6")

### Star Screwdrivers:

Model	Blade Diameter x Length
T32045	T10 x 80mm (T10 x 3-1/8")
T32046	T15 x 80mm (T15 x 3-1/8")
T32047	T20 x 100mm (T20 x 4")
T32048	T25 x 100mm (T25 x 4")
T32049	T30 x 125mm (T30 x 5")
T32050	T40 x 150mm (T40 x 6")
T32051	T27 x 125mm (T27 x 5")



### T32090 5pc "Super Grip" Screwdriver Set

- Contents: (Chrome Molybdenum steel)
  - 3 - Slotted:
    - 4.0mm x 80mm (5/32" x 3-1/8")
    - 5.5mm x 125mm (7/32" x 5")
    - 6.5mm x 150mm (1/4" x 6")
  - 2 - Phillips:
    - #1 x 80mm (#1 x 3-1/8")
    - #2 x 100mm (#2 x 4")



### T32096 5pc "Super Grip" Screwdriver Set

- Contents: (Chrome Molybdenum steel)
  - 3 - Slotted:
    - 4.0mm x 80mm (5/32" x 3-1/8")
    - 5.5mm x 125mm (7/32" x 5")
    - 6.5mm x 150mm (1/4" x 6")
  - 2 - Pozi:
    - #1 x 80mm (#1 x 3-1/8")
    - #2 x 100mm (#2 x 4")



### T32099 7pc "Super Grip" Screwdriver Set

- Contents: (Chrome Molybdenum steel)
  - 4 - Slotted:
    - 4.0mm x 80mm (5/32" x 3-1/8")
    - 5.5mm x 125mm (7/32" x 5")
    - 6.5mm x 150mm (1/4" x 6")
    - 8.0mm x 150mm (5/16" x 6")
  - 3 - Phillips:
    - #1 x 80mm (#1 x 3-1/8")
    - #2 x 100mm (#2 x 4")
    - #3 x 150mm (#3 x 6")



### T32091 7pc "Super Grip" Screwdriver Set

- Contents: (Chrome Molybdenum steel)
  - 4 - Slotted:
    - 4.0mm x 80mm (5/32" x 3-1/8")
    - 5.5mm x 125mm (7/32" x 5")
    - 6.5mm x 150mm (1/4" x 6")
    - 8.0mm x 200mm (5/16" x 8")
  - 3 - Phillips:
    - #1 x 80mm (#1 x 3-1/8")
    - #2 x 100mm (#2 x 4")
    - #3 x 150mm (#3 x 6")



## T32097 7pc "Super Grip" Screwdriver Set

- Contents: (Chrome Molybdenum steel)
  - 4 - Slotted:
    - 4.0mm x 80mm (5/32" x 3-1/8")
    - 5.5mm x 125mm (7/32" x 5")
    - 6.5mm x 150mm (1/4" x 6")
    - 8.0mm x 200mm (5/16" x 8")
  - 3 - Pozzi:
    - #1 x 80mm (#1 x 3-1/8")
    - #2 x 100mm (#2 x 4")
    - #3 x 150mm (#3 x 6")



## T32092 8pc "Super Grip" Screwdriver Set

- Contents: (Chrome Molybdenum steel)
  - 4 - Slotted:
    - 4.0mm x 80mm (5/32" x 3-1/8")
    - 5.5mm x 125mm (7/32" x 5")
    - 6.5mm x 38mm (1/4" x 1-1/2")
    - 6.5mm x 150mm (1/4" x 6")
  - 4 - Phillips:
    - #1 x 80mm (#1 x 3-1/8")
    - #2 x 38mm (#2 x 1-1/2")
    - #2 x 100mm (#2 x 4")
    - #3 x 150mm (#3 x 6")



## "Super Grip" Bit Drivers

- Features a large handle that fits all regions of the hand

### T32060 "Super Grip" Bit Driver

### T32061 "Super Grip" Bit Driver w/ 125mm Shank





## "Cushion Grip" Screwdrivers



12

### Slotted Screwdrivers:

Model	Blade Diameter x Length
T32200	3.2mm x 45mm (1/8" x 1-3/4")
T32201	3.2mm x 75mm (1/8" x 3")
T32203	4mm x 75mm (5/32" x 3")
T32204	5mm x 75mm (3/16" x 3")
T32205	5mm x 100mm (3/16" x 4")
T32206	5mm x 150mm (3/16" x 6")
T32209	6mm x 38mm (1/4" x 1-1/2")
T32212	6mm x 100mm (1/4" x 4")
T32214	6mm x 150mm (1/4" x 6")
T32215	6mm x 200mm (1/4" x 8")
T32216	8mm x 150mm (5/16" x 6")
T32217	8mm x 200mm (5/16" x 8")
T32218	9.5mm x 250mm (3/8" x 10")
T32219	8mm x 300mm (5/16" x 12")

### Phillips Screwdrivers:

Model	Blade Diameter x Length
T32220	#0 x 57mm (#0 x 2-1/4")
T32221	#0 x 75mm (#0 x 3")
T32223	#1 x 38mm (#1 x 1-1/2")
T32224	#1 x 75mm (#1 x 3")
T32225	#1 x 100mm (#1 x 4")
T32226	#1 x 150mm (#1 x 6")
T32228	#1 x 250mm (#1 x 10")
T32229	#2 x 38mm (#2 x 1-1/2")
T32232	#2 x 100mm (#2 x 4")
T32234	#2 x 150mm (#2 x 6")
T32238	#2 x 300mm (#2 x 12")
T32236	#3 x 150mm (#3 x 6")
T32235	#3 x 200mm (#3 x 8")
T32239	#3 x 300mm (#3 x 12")

### Pozi Screwdrivers:

Model	Blade Diameter x Length
T32252	#1 x 75mm (#1 x 3")
T32253	#1 x 100mm (#1 x 4")
T32254	#2 x 38mm (#2 x 1-1/2")
T32255	#2 x 100mm (#2 x 4")
T32256	#2 x 150mm (#2 x 6")
T32257	#3 x 150mm (#3 x 6")

### Star Screwdrivers:

Model	Blade Diameter x Length
T32260	T10 x 100mm (T10 x 4")
T32261	T15 x 100mm (T15 x 4")
T32262	T20 x 100mm (T20 x 4")
T32263	T25 x 100mm (T25 x 4")
T32264	T27 x 100mm (T27 x 4")
T32265	T30 x 100mm (T30 x 4")

### T32290 2pc Star Screwdriver Set (T15 & T20)

- Cushioned grip for extra comfort and high torque
- Chrome Vanadium steel
- Magnetic tip T15, T20



### T32293 6pc "Cushion Grip" Screwdriver Set

- Contents: (Chrome Vanadium steel)
  - 3 - Slotted:
    - 5mm x 100mm (3/16" x 4")
    - 6mm x 38mm (1/4" x 1-1/2")
    - 6mm x 100mm (1/4" x 4")
  - 3 - Phillips:
    - #1 x 75mm (#1 x 3")
    - #2 x 38mm (#2 x 1-1/2")
    - #2 x 100mm (#2 x 4")



### T32296 8pc "Cushion Grip" Screwdriver Set

- Contents: (Chrome Vanadium steel)
  - 5 - Slotted:
    - 6mm x 38mm (1/4" x 1-1/2")
    - 5mm x 75mm (3/16" x 3")
    - 6mm x 100mm (1/4" x 4")
    - 8mm x 150mm (5/16" x 6")
    - 9.5mm x 200mm (3/8" x 8")
  - 3 - Phillips:
    - #1 x 75mm (#1 x 3")
    - #2 x 38mm (#2 x 1-1/2")
    - #2 x 100mm (#2 x 4")



### T32294 10pc "Cushion Grip" Screwdriver Set

- Contents: (Chrome Vanadium steel)
  - 5 - Slotted:
    - 3.2mm x 75mm (1/8" x 3")
    - 5mm x 100mm (3/16" x 4")
    - 6mm x 38mm (1/4" x 1-1/2")
    - 6mm x 100mm (1/4" x 4")
    - 8mm x 200mm (5/16" x 8")
  - 5 - Phillips:
    - #0 x 75mm (#0 x 3"), #1 x 75mm (#1 x 3")
    - #2 x 38mm (#2 x 1-1/2"), #2 x 100mm (#2 x 4")
    - #3 x 150mm (#3 x 6")







### **T32295 21pc Professional Screwdriver Set**

- Curved handle for extra comfort & high torque
- Two-tone colored grip
- Blowcase for convenient storage
- Contents: (Chrome Vanadium steel)
  - 7 - Phillips:
    - #0 x 57mm (#0 x 2-1/4"), #1 x 38mm (#1 x 1-1/2")
    - #1 x 75mm (#1 x 3"), #1 x 100mm (#1 x 4")
    - #2 x 150mm (#2 x 6"), #3 x 150mm (#3 x 6")
    - #3 x 200mm (#3 x 8")
  - 8 - Slotted:
    - 6mm x 38mm (1/4" x 1-1/2"), 3.2mm x 45mm (1/8" x 1-3/4")
    - 4mm x 75mm (5/32" x 3"), 5mm x 100mm (3/16" x 4")
    - 5mm x 150mm (3/16" x 6"), 6mm x 150mm (1/4" x 6")
    - 8mm x 200mm (5/16" x 8"), 9.5mm x 250mm (3/8" x 10")
  - 6 - Precision Screwdriver:
    - 3 - Phillips: #00 x 25mm, # 0 x 25mm, # 1 x 25mm
    - 3 - Slotted: 1.4mm x 25mm, 1.8mm x 25mm, 2.4mm x 25mm



## "Comfort Grip" Screwdrivers

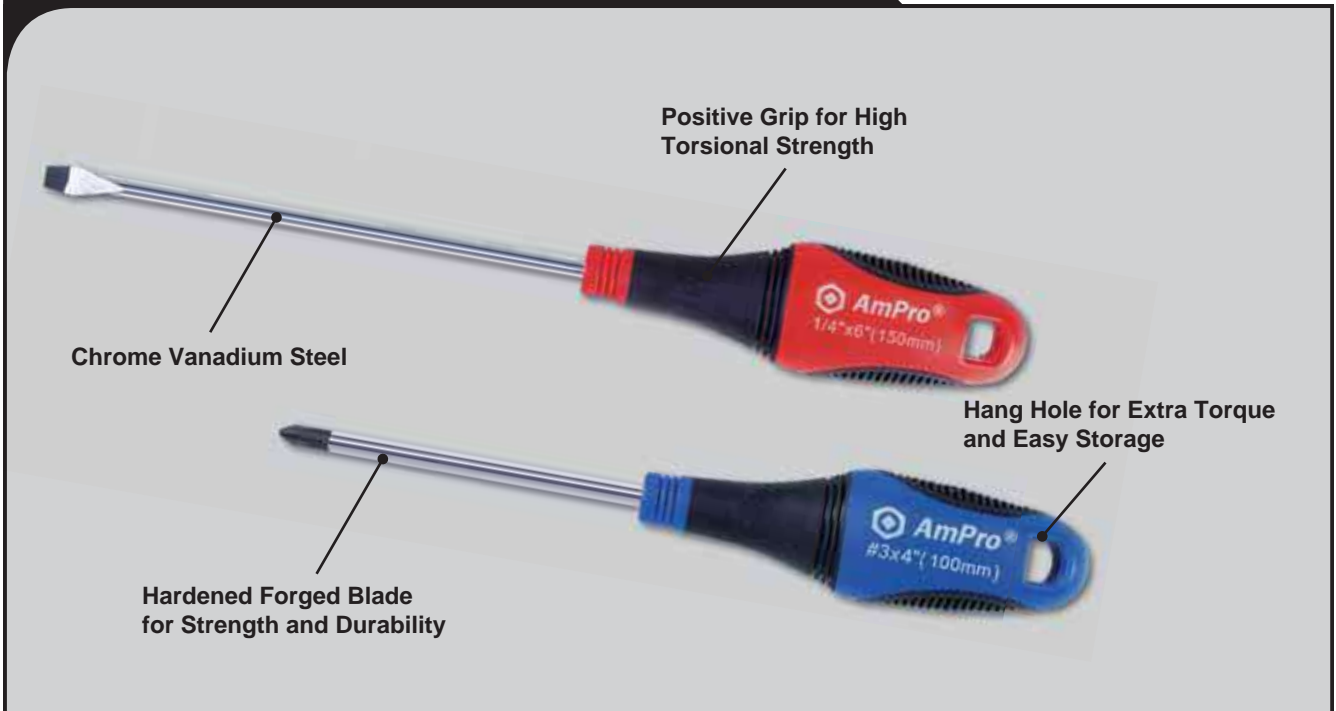

12

### Slotted Screwdrivers:

Model	Blade Diameter x Length	
T32800	3.2mm x 50mm	(1/8" x 2")
T32801	3.2mm x 75mm	(1/8" x 3")
T32804	5mm x 75mm	(3/16" x 3")
T32805	5mm x 100mm	(3/16" x 4")
T32806	5mm x 150mm	(3/16" x 6")
T32807	5mm x 200mm	(3/16" x 8")
T32808	5mm x 250mm	(3/16" x 10")
T32809	6mm x 38mm	(1/4" x 1-1/2")
T32812	6mm x 100mm	(1/4" x 4")
T32814	6mm x 150mm	(1/4" x 6")
T32815	6mm x 200mm	(1/4" x 8")
T32816	8mm x 150mm	(5/16" x 6")
T32817	8mm x 200mm	(5/16" x 8")

### Phillips Screwdrivers:

Model	Blade Diameter x Length	
T32821	#0 x 75mm	(#0 x 3")
T32822	#0 x 100mm	(#0 x 4")
T32824	#1 x 75mm	(#1 x 3")
T32825	#1 x 100mm	(#1 x 4")
T32826	#1 x 150mm	(#1 x 6")
T32827	#1 x 200mm	(#1 x 8")
T32828	#1 x 250mm	(#1 x 10")
T32829	#2 x 38mm	(#2 x 1-1/2")
T32832	#2 x 100mm	(#2 x 4")
T32834	#2 x 150mm	(#2 x 6")
T32835	#2 x 200mm	(#2 x 8")
T32836	#3 x 150mm	(#3 x 6")
T32837	#3 x 200mm	(#3 x 8")

### Pozi Screwdrivers:

Model	Blade Diameter x Length	
T32839	#0 x 75mm	(#0 x 3")
T32840	#1 x 75mm	(#1 x 3")
T32841	#1 x 100mm	(#1 x 4")
T32842	#2 x 100mm	(#2 x 4")
T32843	#3 x 150mm	(#3 x 6")





### T32890 5pc "Comfort Grip" Screwdriver Set

- Contents: (Chrome Vanadium steel)
  - 3 - Slotted:
    - 3.0mm x 75mm (1/8" x 3")
    - 5mm x 100mm (3/16" x 4")
    - 6mm x 150mm (1/4" x 6")
  - 2 - Phillips:
    - #1 x 75mm (#1 x 3")
    - #2 x 100mm (#2 x 4")



### T32891 6pc "Comfort Grip" Screwdriver Set

- Contents: (Chrome Vanadium steel)
  - 3 - Slotted:
    - 3.0mm x 75mm (1/8" x 3")
    - 5mm x 100mm (3/16" x 4")
    - 6mm x 150mm (1/4" x 6")
  - 3 - Phillips:
    - #0 x 75mm (#0 x 3")
    - #1 x 75mm (#1 x 3")
    - #2 x 100mm (#2 x 4")



### T32894 8pc "Comfort Grip" Screwdriver Set

- Contents: (Chrome Vanadium steel)
  - 4 - Slotted:
    - 3.0mm x 75mm (1/8" x 3")
    - 5mm x 100mm (3/16" x 4")
    - 6mm x 150mm (1/4" x 6")
    - 8mm x 200mm (5/16" x 8")
  - 4 - Phillips:
    - #0 x 75mm (#0 x 3"), #1 x 100mm (#1 x 4")
    - #2 x 100mm (#2 x 4"), #3 x 150mm (#3 x 6")



### T32893 10pc "Comfort Grip" Screwdriver Set

- Contents: (Chrome Vanadium steel)
  - 5 - Slotted:
    - 3.0mm x 75mm (1/8" x 3")
    - 5mm x 100mm (3/16" x 4")
    - 6mm x 38mm (1/4" x 1-1/2")
    - 6mm x 150mm (1/4" x 6")
    - 8mm x 200mm (5/16" x 8")
  - 5 - Phillips:
    - #0 x 75mm (#0 x 3"), #1 x 100mm (#1 x 4")
    - #2 x 38mm (#2 x 1-1/2"), #2 x 100mm (#2 x 4")
    - #3 x 150mm (#3 x 6")



### T32892 8pc "Comfort Grip" Screwdriver Set

- Contents: (Chrome Vanadium steel)
  - 4 - Slotted:
    - 5mm x 100mm (3/16" x 4")
    - 6mm x 38mm (1/4" x 1-1/2")
    - 6mm x 100mm (1/4" x 4")
    - 8mm x 150mm (5/16" x 6")
  - 4 - Phillips:
    - #0 x 75mm (#0 x 3"), #2 x 38mm (#2 x 1-1/2")
    - #2 x 100mm (#2 x 4"), #3 x 150mm (#3 x 6")



## "Firm Grip" Screwdrivers

In "Firm Grip", the fine contoured surface of the handle provides extra comfort and grip when held. The cold-forged, heat-treated blade with vapor-blasted tip provides the ideal grip between the driver and screw.



### Slotted Screwdrivers:

Model	Blade Diameter x Length
<b>T32501</b>	3.2mm x 75mm (1/8" x 3")
<b>T32504</b>	5mm x 75mm (3/16" x 3")
<b>T32505</b>	5mm x 100mm (3/16" x 4")
<b>T32509</b>	6mm x 38mm (1/4" x 1-1/2")
<b>T32512</b>	6mm x 100mm (1/4" x 4")
<b>T32514</b>	6mm x 150mm (1/4" x 6")
<b>T32516</b>	8mm x 150mm (5/16" x 6")
<b>T32519</b>	9.5mm x 200mm (3/8" x 8")

### Phillips Screwdrivers:

Model	Blade Diameter x Length
<b>T32521</b>	#0 x 75mm (#0 x 3")
<b>T32524</b>	#1 x 75mm (#1 x 3")
<b>T32529</b>	#2 x 38mm (#2 x 1-1/2")
<b>T32532</b>	#2 x 100mm (#2 x 4")
<b>T32534</b>	#2 x 150mm (#2 x 6")
<b>T32536</b>	#3 x 150mm (#3 x 6")
<b>T32537</b>	#9.5 x 200mm (#4 x 8")

### T32163 22pc Professional Screwdriver Set

- Color coded handles for easy identification
- Square shaft for slotted screwdrivers
- Includes 4 handy storage trays
- Contents: (Chrome Vanadium steel)
  - 5 - Slotted:
    - 3/16" x 100mm (3/16" x 4"), 1/4" x 38mm (1/4" x 1-1/2")
    - 1/4" x 100mm (1/4" x 4"), 1/4" x 150mm (1/4" x 6")
    - 5/16" x 200mm (5/16" x 8")
  - 3 - Phillips:
    - #2 x 100mm (#2 x 4"), #1 x 75mm (#1 x 3")
    - #2 x 38mm (#2 x 1-1/2")
  - 3 - Precision Slotted:
    - 5/64" x 3" (5/64 x 75mm), 3/32" x 3" (3/32" x 75mm)
    - 1/8" x 3" (1/8" x 75mm)
  - 2 - Precision Phillips:
    - #0 x 3" (#0 x 75mm), #00 x 3" (#00 x 75mm)
  - 5 - Star: T10, T15, T20, T25, T30
  - 4 - Nut Driver: 3/16", 1/4", 5/16", 3/8"





## Heavy Duty Go-Thru Screwdrivers

- Steel end cap withstands striking blows
- Hex bolstered shaft for extra turning power



### Slotted Screwdrivers:

Model	Blade Diameter x Length
T32405	5.5mm x 100mm (7/32" x 4")
T32410	6.5mm x 100mm (1/4" x 4")
T32414	6.5mm x 150mm (1/4" x 6")
T32418	8.0mm x 150mm (5/16" x 6")
T32417	8.0mm x 175mm (5/16" x 7")
T32419	8.0mm x 200mm (5/16" x 8")
T32421	10mm x 200mm (3/8" x 8")
T32423	12mm x 200mm (15/32" x 8")

### Phillips Screwdrivers:

Model	Blade Diameter x Length
T32424	# 1 x 75mm (#1 x 3")
T32432	# 2 x 100mm (#2 x 4")
T32433	# 2 x 150mm (#2 x 6")
T32434	# 2 x 200mm (#2 x 8")
T32436	# 3 x 150mm (#3 x 6")
T32437	# 3 x 200mm (#3 x 8")
T32440	# 4 x 200mm (#4 x 8")
T32441	# 4 x 250mm (#4 x 10")

### Pozi Screwdrivers:

Model	Blade Diameter x Length
T32460	# 1 x 75mm (#1 x 3")
T32461	# 2 x 100mm (#2 x 4")
T32462	# 3 x 150mm (#2 x 6")



### T32188 6pc Heavy Duty Go-Thru Screwdriver Set

- Steel end cap with stands striking blows
- Hex bolster and shaft for extra turning power
- Ribbed, cushioned handle for secure grip
- Magnetic tips
- Contents: (Chrome Molybdenum steel)
  - 3 - Slotted:
    - 5.5mm x 100mm (7/32" x 4")
    - 6.5mm x 150mm (1/4" x 6")
    - 8.0mm x 175mm (5/16" x 7")
  - 3 - Phillips:
    - #1 x 75mm (#1 x 3")
    - #2 x 100mm (#2 x 4")
    - #3 x 150mm (#3 x 6")

## T32183 2pc Heavy Duty Go-Thru Screwdriver Set

- Contents: (Chrome Molybdenum steel)
  - 1 - Slotted:  
6.5 x 100mm (1/4" x 4")
  - 1 - Phillips:  
#2 x 100mm (#2 x 4")



## T32186 5pc Go-Thru Extra Long Shaft Screwdriver Set

- Contents: (Chrome Molybdenum steel)
  - 2 - Slotted:
    - 8mm x 200mm (5/16" x 8")
    - 8mm x 305mm (5/16" x 12")
  - 3 - Phillips:
    - #2 x 200mm (#2 x 8")
    - #2 x 305mm (#2 x 12")
    - #2 x 450mm (#2 x 18")



Extra long shaft excellent for working in confined areas







## T32190 8pc Electrical Screwdriver Set (VDE1000V)

- Contents:
  - 3 - Phillips: #0 x 75, #1 x 100, #2 x 100mm
  - 4 - Slotted: 3.0 x 75, 4.0 x 100, 5.5 x 125, 6.5 x 150mm
  - 1 - Circuit Tester: 120V ~ 250V

1000V



## Insulated Hex Nut Drivers (Metric)

- Individually tested to exceed standards
- Cushion-grip handle for greater torque and comfort
- Full hollow shaft facilitates work on long bolt applications

1000V



12

Model	Blade Diameter x Length
T32650	● M4 x 125mm
T32651	● M5 x 125mm
T32652	● M5.5 x 125mm
T32653	● M6 x 125mm
T32654	● M7 x 125mm
T32655	● M8 x 125mm

Model	Blade Diameter x Length
T32656	● M9 x 125mm
T32657	● M10 x 125mm
T32658	● M11 x 125mm
T32659	● M12 x 125mm
T32660	● M13 x 125mm

## Insulated Screwdrivers

- Individually tested to exceed standards
- Cushioned grip handle for greater torque and comfort

1000V



### Slotted Insulated Screwdriver:

Model	Blade Diameter x Length
T32670	⊖ 2.5mm x 75mm
T32671	⊖ 3.0mm x 100mm
T32672	⊖ 4.0mm x 100mm
T32673	⊖ 5.5mm x 125mm
T32674	⊖ 6.5mm x 150mm
T32675	⊖ 8.0mm x 175mm

### Phillips Insulated Screwdriver:

Model	Blade Diameter x Length
T32680	⊕ #0 x 60mm
T32681	⊕ #1 x 80mm
T32682	⊕ #2 x 100mm
T32683	⊕ #3 x 150mm

### Pozi Insulated Screwdriver:

Model	Blade Diameter x Length
T32685	⊕ #0 x 60mm
T32686	⊕ #1 x 80mm
T32687	⊕ #2 x 100mm
T32688	⊕ #3 x 150mm





### T17205 7pc Impact Driver Set

- Loosens rusted or tightened screws, nuts and bolts.
- Forward & reverse ratchet mechanism
- Contents:
  - 1 - Impact Driver
  - 6 - 5/16" Bits:
    - 4 - Phillips: #2 x 36mm, #2 x 80mm, #3 x 36mm, #3 x 80mm
    - 2 - Slotted: 8mm x 36mm, 10mm x 36mm
- Metal Case



### T17206 9pc Impact Driver Set

- Contents:
  - 1 - Impact Driver
  - 8 - 5/16" Bits:
    - 4 - Phillips: #2 x 36mm, #2 x 80mm, #3 x 36mm, #3 x 80mm
    - 2 - Slotted: 8mm x 36mm, 10mm x 36mm
    - 2 - Hex: 4mm x 36mm, 10mm x 36mm
- Blow Case



### T71565 1/2" Dr. Impact Driver Set

### T71566 3/8" Dr. Impact Driver Set

- Perfect for loosening wedge screws and bolts
- Includes 4 bits:
  - Phillips: #2 & #3
  - Slotted: 5/16" & 3/8"



### Professional Nut Driver Sets

#### T32140 4pc Nut Driver Set (Metric)

6, 8, 10, 11mm

#### T32141 4pc Nut Driver Set (SAE)

1/4", 5/16", 3/8", 7/16"

#### T32142 7pc Professional Nut Driver Set (Metric)

5, 6, 7, 8, 9, 10, 11mm

#### T32143 7pc Professional Nut Driver Set (SAE)

3/16", 1/4", 5/16", 11/32", 3/8", 7/16", 1/2"





### T32116 2-in-1 Ratcheting Screwdriver

- Sturdy construction for strength & durability
- Bit extension adaptor included
- Contents:
  - 14 - 1/4" Screwdriver Bits
    - 1 - Bit Extension Adaptor
    - 4 - Phillips: #0, #1, #2, #3
    - 3 - Slotted: 4, 5, 6mm
    - 3 - Star: T15, T20, T25
    - 3 - Hex: 3, 4, 6mm



12

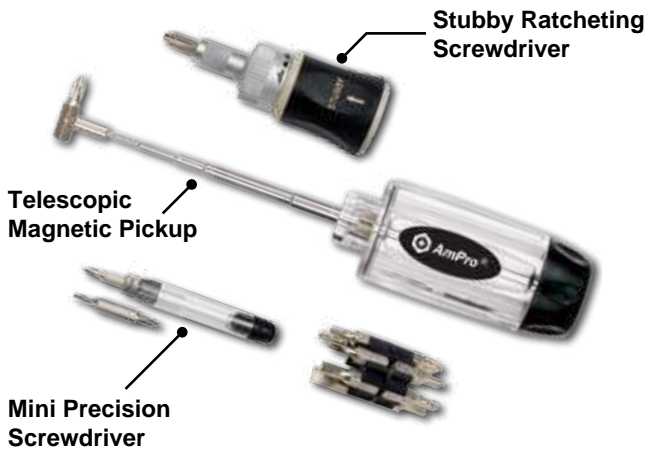

### T32124 18pc 4-in-1 Ratcheting Screwdriver Set



- Stubby screwdriver, standard screwdriver, magnetic pickup tool & precision screwdriver all-in-one
- Contents:
  - 1 - Stubby Ratcheting Screwdriver
  - 1 - Telescopic Magnetic Pickup
  - 1 - Precision Screwdriver Holder
  - 4 - Precision Screwdriver Bits (Double-Ended)
    - Phillips #00 x Slotted 2.0mm
    - Phillips #0 x Slotted 1.5mm
  - 11 - 1/4" Screwdriver Bits
    - 3 - Slotted: 1/8", 3/16", 1/4"
    - 3 - Phillips: #1, #2, #3
    - 3 - Star: T15, T20, T25
    - 2 - Square: S1, S2





### T32117 12-in-1 Ratchet Driver Set

- Double-end bits for convenience
- Forward / reverse ratchet mechanism

	
H3 x H4	SL3/16" x 1/4"
R1 x R2	RH1 x RH2
Pz1 x Pz2	T10 x T15



### T32126 Flex Ratcheting Screwdrivers w/ Lock

- Multi-angle positions for working in confined areas
- Forward-fixed-reverse
- Quick-lock secures angle position
- Chrome Vanadium steel

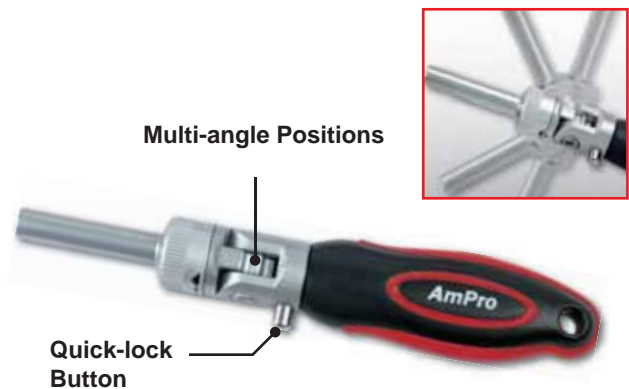

### T32105 6-in-1 Quick Change Screwdriver

- Reversible nut driver
- Cushioned grip handle
- Chrome Vanadium steel bits
- Contents:
  - 1/4" Bit Sizes:
    - Slotted: 3/16", 1/4"
    - Phillips: #1, #2
  - 1/4" & 5/16" Nut Driver



### T32280 6-in-1 Quick Change Screwdriver

- Cushioned grip handle for extra comfort and high torque
- Reversible shank for 1/4" & 5/16" bits
- 2pc Double-sided alloy steel bits
  - Slotted: 3/16", 1/4"
  - Phillips: #1, #2





### 7-in-1 Screwdriver

- Fits phillips and pozi screws
- S2 alloy steel
- Magnetic ring for better holding
- Cushioned grip handle for secure hold

#### T32133 4" (100mm) 7-in-1 Screwdriver

Phillips: #0, #1, #2, #3  
Pozi: #1, #2, #3

#### T32134 11.8" (300mm) 7-in-1 Screwdriver

Phillips: #0, #1, #2, #3  
Pozi: #1, #2, #3



### 8-in-1 Screwdriver

- Double-end bit fits phillips, slotted and pozi screws
- S2 alloy steel bit
- Cushioned grip handle for secure hold

#### T32106 8-in-1 Stubby Screwdriver

Phillips: #0, #1, #2, #3  
Pozi: #1, #2, #3  
Slotted: 6mm

#### T32107 8-in-1 Screwdriver

Phillips: #0, #1, #2, #3  
Pozi: #1, #2, #3  
Slotted : 6mm



#### T32103 Flex-Shaft Extendable Magnetic Ratchet Driver with 6 Bits

- Heavy duty handle with extra bit storage
- Flexible braided steel shaft extends up to 12" (300mm)
- Contents: (S2 alloy steel)
  - 6 - 1/4" Screwdriver Bits
    - 3 - Slotted: 3/16", 1/4", 5/16"
    - 3 - Phillips: #1, #2, #3



#### T32132 Gearless Magnetic Ratchet Driver

- Convenient bit storage in stubby handle
- Forward & reverse ratchet mechanism
- Ergonomic, cushioned grip handle
- Contents:
  - 6 - 1/4" Alloy Steel Bits:
    - Slotted: 3/16", 1/4"
    - Phillips: #1, #2
    - Star: T15, T20

## T32120 6" Gearless Magnetic Ratchet Driver with 7 Bits

- Heavy duty handle with extra bits storage
- Forward & reverse gearless ratchet
- Contents: (S2 alloy steel)
  - 7 - 1/4" Screwdriver Bits
    - 3 - Slotted: 5, 6, 8mm
    - 3 - Phillips: #1, #2, #3
    - 1 - 1/4" Dr. Bit Adaptor



## T32119 Extendable Ratchet Screwdriver

- Stubby and standard length all-in-one
- Extends from 1-1/4" (32mm) to 5-1/2" (140mm)
- Ribbed, soft grip handle
- Forward-reverse ratcheting action



## T32118 Precision Gearless Extendable Ratchet Screwdriver w/ Bits

- Forward-reverse gearless action
- Extends form 1" (25mm) to 3-3/4" (95mm)
- Ribbed, soft grip handle
- Contents:
  - 1 - Gearless Extendable Bit Driver
  - 12 - 1/8" Screwdriver Bits
    - 3 - Phillips: #00, #0, #1
    - 3 - Slotted: 1.0, 1.5, 2.5mm
    - 4 - Star: T5, T6, T7, T8
    - 2 - Hex: 1.5, 2.0mm



## T32114 24pc Gearless Extendable Precision Screwdriver Set

- Forward-reverse gearless action
- Chrome Molybdenum steel blade
- Extends from 1" (25mm) to 3-3/4" (95mm)
- Ribbed, soft grip handle
- Contents:
  - 1 - Gearless Extendable Bit Driver:
    - 1" to 3-3/4" (25mm - 95mm)
  - 4 - Precision Screwdrivers:
    - 2 - Phillips: #0, #1
    - 2 - Slotted: 2.5, 3.0mm
  - 12 - 1/8" Screwdriver Bits:
    - 3 - Phillips: #00, #0, #1
    - 3 - Slotted: 1.0, 1.5, 2.5mm
    - 4 - Star: T5, T6, T7, T8
    - 2 - Hex: 1.5, 2.0mm
  - 6 - Nut Drivers: 2.5, 3.0, 3.5, 4.0, 4.5, 5.0mm
  - 1 - Pocket Magnetic Pickup







### T32109 6-in-1 Gearless Extendable Stubby Precision Screwdriver

- 6 Bits stored in handle
- Extends up to 2-3/4" (70mm)
- Durable Chrome Molybdenum steel bits
- Forward-reverse gearless action
- Contents:
  - 6 - Bits:
    - 3 - Phillips: #00, #0, #1
    - 3 - Slotted: 1.0, 1.5, 2.5mm



### T32156 21pc Precision Screwdriver Set

- Precision formed drivers for accurate fit
- Precision driver handle
- Chrome plated drivers for rust resistance
- Case for convenient storage
- Contents:
  - 1 - Precision Driver Handle
  - 7 - Nut Driver Shafts: 3, 3.5, 4, 4.5, 5, 5.5, 6mm
  - 1 - Bit Coupler Shaft
  - 12 - Bits:
    - 4 - Slotted: 1, 2, 3, 4mm
    - 4 - Phillips: #000, #00, #0, #1
    - 4 - Torx: T6, T7, T8, T9



### T32151 6pc Precision Screwdriver Set

Slotted: 1.4mm, 1.8mm, 2.4mm (25mm)  
Phillips: #00, #0, #1 (25mm)

### T32152 6pc Precision Screwdriver Set

Star: T5, T6, T7, T8, T9, T10 (25mm)

### T32154 6pc Precision Screwdriver Set

Slotted: 2.0mm, 3.0mm, 4.0mm (60mm)  
Phillips: #00, #0, #1 (60mm)

### T32155 6pc Precision Screwdriver Set

Star: T5, T6, T7, T8, T9, T10 (60mm)

Dual Color,  
Aluminum Alloy Handle

Knurled Body for  
Secure Grip



### T32130 3pc Pen-Type Mini Screwdriver Set (Metric)

- Mini size with pocket clip for easy storage & transportation
- Magnetic tip in handle
- Chrome Vanadium steel bits stored in handle

- Contents:
  - 21 - 1/8" Screwdriver Bits:
    - 3 - Phillips: #000, #00, #0 (Red)
    - 4 - Slotted: 1.5, 2, 2.5, 3mm (Red)
    - 5 - Hex: 1.5, 2, 2.5, 3, 4mm (Blue)
    - 2 - Pozi: #0, #1 (Blue)
    - 7 - Star: T6, T7, T8, T9, T10, T15, T20 (Green)



### T32166 12-in-1 Adjustable Precision Screwdriver Set

- Chrome Molybdenum steel blade
- Impact resistant handle
- Hexagon shank with phosphate finish tip
- Brass screw cap design allows flexible length adjustment
- Contents:
  - Slotted: 2, 3, 4mm
  - Phillips: #00, #0, #1
  - Star: T5, T6, T8, T10, T15, T20



### T32168 6pc Precision Screwdriver Set

- Hardened alloy steel blades
- Convenient storage case
- Contents:
  - 4 - Slotted: 1.4, 2.0, 2.4, 3.0mm
  - 2 - Phillips: #0, #1



### Offset Star Driver Set

- Drop-forged, chrome plated steel
- Offset design reaches confined areas

### T32170 2pc Offset Screwdriver Set

Phillips: #1, #2  
Slotted: 3/16", 1/4"

### T32171 2pc Offset Star Driver Set

Star: T10, T15, T20, T30



### T70702 4pc Pry Bar Set

- Heat-treated, drop forged steel
- High impact handles for extra leverage
- Sizes:
  - 8" (200mm), 12" (300mm), 18" (450mm), 24" (600mm)





### T70703 4pc Jumbo Pry Bar Set

- Chrome Molybdenum steel
- High impact resistant handle
- Stain finish for corrosion resistance
- Sizes:  
30° x 36" (915mm), 0° x 36" (915mm),  
90° x 24" (600mm), 45° x 24" (600mm)



### T32175 4pc Heavy Duty Pry Bar Set

- Chrome Vanadium steel
- High impact resistant handle
- Satin finish for corrosion resistance
- Sizes:  
8" (200mm), 12" (300mm), 18" (450mm), 24" (600mm)



### T32178 4pc Pry Bar & Wrecking Bar Set

- Ideal for all forms of force work: opening packing cases, removing nails, aligning heavy equipment, etc.
- Black oxide finish
- Drop-forged, heat-treated steel for strength and durability
- Contents:  
1 - 15" x 1-3/8" x 1/4" (380mm x 35mm x 6mm) Flat Pry Bar  
1 - 16" x 5/8" (400mm x 16mm) Wrecking Bar  
1 - 10" x 23/32" (250mm x 18mm) Cold Chisel  
1 - 24" x 3/4" (600mm x 19mm) Aligning Bar



Medium-steel bar for prying, cutting, and digging work



Sharp blades for easy insertion



Beveled slot pulls out nails easily



Pry bar provides excellent leverage





# Screwdriver Bits & Bit Sets





## Color Coded Bits

- S2 alloy steel bits
- Quick-lock / release bit coupler
- Color-coded bits for quick identification



### T33700 15pc Color Coded Bit Set

- Contents: (S2 Alloy Steel Bits)
- 14 - Color Coded Bits (25mm):
  - 2 - Phillips: #1, #2
  - 2 - Slotted: 4, 6mm
  - 2 - Pozzi: #1, #2
  - 3 - Hex: 3, 4, 5mm
  - 5 - Star: T10, T15, T20, T25, T30
- 1 - 1/4" Quick-Release Bit Coupler



### 15pc Color Coded Bit Set



Model Contents:

<b>T12090</b>	<ul style="list-style-type: none"> <li>3mm (4pc)</li> <li>6mm (3pc)</li> </ul>	<ul style="list-style-type: none"> <li>4mm (4pc)</li> </ul>	<ul style="list-style-type: none"> <li>5mm (4pc)</li> </ul>
<b>T12092</b>	<ul style="list-style-type: none"> <li>#1 (5pc)</li> </ul>	<ul style="list-style-type: none"> <li>#2 (5pc)</li> </ul>	<ul style="list-style-type: none"> <li>#3 (5pc)</li> </ul>
<b>T12094</b>	<ul style="list-style-type: none"> <li>T10 (3pc)</li> <li>T25 (2pc)</li> <li>T40 (2pc)</li> </ul>	<ul style="list-style-type: none"> <li>T15 (2pc)</li> <li>T27 (2pc)</li> </ul>	<ul style="list-style-type: none"> <li>T20 (2pc)</li> <li>T30 (2pc)</li> </ul>
<b>T12096</b>	<ul style="list-style-type: none"> <li>T10 (3pc)</li> <li>T25 (2pc)</li> <li>T40 (2pc)</li> </ul>	<ul style="list-style-type: none"> <li>T15 (2pc)</li> <li>T27 (2pc)</li> </ul>	<ul style="list-style-type: none"> <li>T20 (2pc)</li> <li>T30 (2pc)</li> </ul>
<b>T12100</b>	<ul style="list-style-type: none"> <li>#1 (5pc)</li> </ul>	<ul style="list-style-type: none"> <li>#2 (5pc)</li> </ul>	<ul style="list-style-type: none"> <li>#3 (5pc)</li> </ul>
<b>T12098</b>	<ul style="list-style-type: none"> <li>3mm (4pc)</li> <li>6mm (3pc)</li> </ul>	<ul style="list-style-type: none"> <li>4mm (4pc)</li> </ul>	<ul style="list-style-type: none"> <li>5mm (4pc)</li> </ul>

### T33706 32pc Color Coded Bit Set

- Includes belt clip
- Contents: (S2 Alloy Steel Bits)
- 30 - Color Coded Bits (25mm):
  - 4 - Phillips: #1, #2 (2pc), #3
  - 4 - Slotted: 3, 4, 5, 6mm
  - 4 - Pozzi: #1, #2 (2pc), #3
  - 4 - Hex: 3, 4, 5, 6mm
  - 7 - Star: T10, T15, T20, T25, T27, T30, T40
  - 7 - Tamper-Proof Star: T10, T15, T20, T25, T27, T30, T40
- 1 - 1/4" Dr. Bit Adaptor
- 1 - 1/4" Quick-Release Bit Coupler

### T33707 32pc Color Coded Bit & Ratchet Bit Driver Set

- Includes belt clip
- Contents: (S2 Alloy Steel Bits)
- 30 - Color Coded Bits (25mm):
  - 4 - Phillips: #1, #2 (2pc), #3
  - 4 - Slotted: 3, 4, 5, 6mm
  - 4 - Pozzi: #1, #2 (2pc), #3
  - 4 - Hex: 3, 4, 5, 6mm
  - 7 - Star: T10, T15, T20, T25, T27, T30, T40
  - 7 - Tamper-Proof Star: T10, T15, T20, T25, T27, T30, T40
- 1 - 1/4" Bit Holder
- 1 - Ratchet Bit Driver

## T33710 26pc Color Coded Bit Set

- Contents: (S2 Alloy Steel Bits)
- 18 - Color Coded Bits (25mm):
  - 3 - Phillips: #1, #2, #3
  - 3 - Slotted: 4, 4.5, 6.5mm
  - 3 - Pozi: #1, #2, #3
  - 4 - Hex: 3, 4, 5, 6mm
  - 5 - Star: T10, T15, T20, T25, T30
- 5 - Sockets: 6, 7, 8, 10, 13mm (CR-V)
- 1 - 1/4" Dr Coupler
- 1 - 1/4" Dr. Extension Bar: 50mm
- 1 - 1/4" Dr. Mini Ratchet



## T33713 71pc Color Coded Bit Set

- Contents: (S2 Alloy Steel Bits)
- 60 - Color Coded Bits (25mm):
  - 12 - Phillips: #1 (3pc), #2 (6pc), #3 (3pc)
  - 6 - Slotted: 4 (3pc), 6mm (3pc)
  - 12 - Pozi: #1 (3pc), #2 (6pc), #3 (3pc)
  - 9 - Hex: 4 (3pc), 5 (3pc), 6mm (3pc)
  - 21 - Star: T10 (3pc), T15 (3pc), T20 (3pc), T25 (3pc), T27 (3pc), T30 (3pc), T40 (3pc)
- 9 - Color Coded Bits (75mm):
  - 3 - Phillips: #1, #2, #3
  - 2 - Slotted: 4, 6mm
  - 2 - Pozi: #1, #2
  - 2 - Star: T20, T25
- 1 - 1/4" Bit Holder
- 1 - 1/4" Quick-Release Bit Coupler



## T33714 86pc Color Coded Bit & Extendable Geared Screw Driver Set

- Contents: (S2 Alloy Steel Bits)
- 70 - Color Coded Bits (25mm):
  - 15 - Phillips: #1 (5pc), #2 (5pc), #3 (5pc)
  - 10 - Slotted: 4 (5pc), 6mm (5pc)
  - 15 - Pozi: #1 (5pc), #2 (5pc), #3 (5pc)
  - 15 - Hex: 4 (5pc), 5 (5pc), 6mm (5pc)
  - 10 - Star: T10 (2pc), T15 (2pc), T20 (2pc), T25 (2pc), T30 (2pc)
  - 5 - Tamper-Proof Star: T10, T15, T20, T25, T30
- 13 - Color Coded Bits (90mm):
  - 3 - Phillips: #2 (3pc)
  - 3 - Pozi: #2 (3pc)
  - 7 - Star: T10, T15, T20 (3pc), T25, T30
- 1 - Reversible Bits Driver Handle w/ Extension Bar
- 1 - 1/4" Bit Holder
- 1 - One-Touch Magnetic Bit Holder







### T45106 18pc 2-Way Reversible Ratchet 1/4" Dr. Socket & Bit Set

- Chrome Vanadium steel
- Contents: (S2 Alloy Steel Bits)
  - 1 - 2-Way Reversible Ratchet
  - 1 - Spin Disk
  - 6 - 1/4" Dr. Sockets: 3/16", 1/4", 5/16", 11/32", 3/8" & 7/16"
  - 10 - 1/4" Screwdriver Bits:
    - 2 - Phillips: #1, #2
    - 2 - Slotted: 3/16", 1/4"
    - 4 - Hex: 1/8", 5/32", 3/16", 7/32"
    - 2 - Star: T15, T20



13



### T45107 38pc 1/4" Dr. Socket & Bit Set

- Contents: (S2 Alloy Steel Bits)
  - 22 - 1/4" Screwdriver Bits (25mm):
    - 4 - Phillips: #1, #2 (2pc), #3
    - 4 - Slotted: 3, 4, 5, 6mm
    - 4 - Pozi: #1, #2 (2pc), #3
    - 3 - Hex: 4, 5, 6mm
    - 7 - Star: T10, T15, T20, T25, T27, T30, T40
  - 11 - 1/4" Dr. 6pt Sockets:
    - 4, 4.5, 5, 5.5, 6, 7, 8, 9, 10, 11, 12mm
  - 1 - 1/4" x 5/16" Double-Way Ratchet: 115mm
  - 1 - 1/4" Dr. Extension Bar: 50mm
  - 1 - 1/4" Dr. x 1/4" Bit Adaptor
  - 1 - 1/4" x 5/16" Adaptor
  - 1 - 1/4" Bit Holder



### T33263 31pc 1/4" Dr. Professional Bit Set

- Contents: (S2 Alloy Steel Bits)
  - 30 - 1/4" Screwdriver Bits (25mm):
    - 4 - Phillips: #1, #2 (2pc), #3
    - 4 - Slotted: 3, 4, 5, 6mm
    - 4 - Pozi: #1, #2 (2pc), #3
    - 4 - Hex: 3, 4, 5, 6mm
    - 7 - Star: T10, T15, T20, T25, T27, T30, T40
    - 7 - Tamper-Proof Star: T10, T15, T20, T25, T27, T30, T40
  - 1 - 1/4" Quick-Release Bit Coupler



### T33260 100pc 1/4" Dr. Professional Bit Set

- Contents: (S2 Alloy Steel Bits)
  - 98 - 1/4" Screwdriver Bits (25mm):
    - 21 - Phillips: #1 (7pc), #2 (7pc), #3 (7pc)
    - 14 - Slotted: 4 (7pc), 6mm (7pc)
    - 21 - Pozi: #1 (7pc), #2 (7pc), #3 (7pc)
    - 21 - Hex: 4 (7pc), 5 (7pc), 6mm (7pc)
    - 14 - Star: T10 (2pc), T15 (2pc), T20 (2pc), T25 (2pc), T27 (2pc), T30 (2pc), T40 (2pc)
    - 7 - Tamper-Proof Star: T10, T15, T20, T25, T27, T30, T40
  - 1 - 1/4" Bit Holder
  - 1 - 1/4" Quick-Release Bit Coupler



## T33253 37pc Ratchet Bit Driver & Bit Set

- Contents: (Chrome Vanadium Steel Bits)
  - 1 - Ratchet Bit Driver
  - 36 - 1/4" Screwdriver Bits (25mm)
    - 7 - Phillips: #0 (2pc), #1 (2pc), #2 (2pc), #3
    - 4 - Slotted: 4, 5, 5.5, 6mm
    - 4 - Pozi: #0, #1, #2, #3
    - 9 - Hex: 2, 2.5, 3, 4 (2pc), 5 (2pc), 5.5, 6mm
    - 6 - Star: T10, T15, T20, T25, T30, T40
    - 4 - Tamper-Proof: T10, T15, T20, T30
    - 2 - Square: S1, S2



## T33266 32pc Professional Bit Set

- Contents: (S2 Alloy Steel Bits)
  - 30- 1/4" Screwdriver Bits (25mm):
    - 4- Phillips: #1, #2 (2pc), #3
    - 4- Slotted: 3, 4, 5, 6mm
    - 4- Pozi: #1, #2 (2pc), #3
    - 4- Hex: 3, 4, 5, 6mm
    - 7- Star: T10, T15, T20, T25, T27, T30, T40
    - 7- Tamper-Proof Star: T10, T15, T20, T25, T27, T30, T40
  - 1- 1/4" Dr. Bit Adaptor
  - 1- 1/4" Quick-Release Bit Coupler



## T33722 28pc 1/4" Dr. Mini Ratchet, Bit & Fits-All (Spline) Socket Set

- Contents: (S2 Alloy Steel Bits)
  - 12 - 1/4" Screwdriver Bits (25mm):
    - 3 - Phillips: #1, #2, #3
    - 3 - Slotted: 4, 5, 6mm
    - 3 - Pozi: #1, #2, #3
    - 3 - Hex: 4, 5, 6mm
  - 13 - 1/4" Fits-All Sockets:
    - 4, 4.5, 5, 5.5, 6, 7, 8, 9, 10, 11, 12, 13, 14mm
  - 1 - 1/4" Dr. Bit Adaptor
  - 1 - 1/4" Dr. Extension Bar: 50mm
  - 1 - 1/4" Mini Ratchet



## T33250 32pc 1/4" Dr. Mini Ratchet Bit Driver & Bit Set

- Contents: (S2 Alloy Steel Bits)
  - 29 - 1/4" Screwdriver Bits (25mm):
    - 3 - Phillips: #1, #2, #3
    - 4 - Slotted: 4, 5.5, 6.5, 8mm
    - 3 - Pozi: #1, #2, #3
    - 4 - Hex: 3, 4, 5, 6mm
    - 8 - Star: T8, T10, T15, T20, T25, T27, T30, T40
    - 7 - Tamper-Proof Star: T10, T15, T20, T25, T27, T30, T40
  - 1 - 1/4" Dr. Bit Adaptor
  - 1 - 1/4" Quick-Release Bit Coupler
  - 1 - Ratchet Bit Driver





### T33274 113pc Bit Set

- Contents: (S2 Alloy Steel Bits)
  - 98 - 1/4" Screwdriver Bits (25mm):
    - 21 - Phillips: #1 (7pc), #2 (7pc), #3 (7pc)
    - 14 - Slotted: 4 (7pc), 6mm (7pc)
    - 21 - Pozi: #1 (7pc), #2 (7pc), #3 (7pc)
    - 21 - Hex: 4 (7pc), 5 (7pc), 6mm (7pc)
    - 14 - Star: T10 (2pc), T15 (2pc), T20 (2pc), T25 (2pc), T27 (2pc), T30 (2pc), T40 (2pc)
    - 7 - Tamper-Proof Star: T10, T15, T20, T25, T27, T30, T40
  - 13 - 1/4" Screwdriver Bits (75mm):
    - 3 - Phillips: #2 (3pc)
    - 3 - Pozi: #2 (3pc)
    - 7 - Star: T10, T15, T20 (3pc), T25, T30
  - 1 - 1/4" Bit Holder
  - 1 - 1/4" Quick-Release Bit Coupler

13



### T33267 148pc Master Bit Set

- Contents: (S2 Alloy Steel Bits)
  - 79 - 1/4" Screwdriver Bits (25mm):
    - 8 - Phillips: #00, #0, #1, #2 (3pc), #3, #4
    - 12 - Slotted: 2, 2.5, 3, 3.5, 4, 4.5, 5, 5.5, 6, 6.5, 7, 8mm
    - 10 - Hex: 1/16", 5/64", 3/32", 7/64", 1/8", 9/64", 5/32", 3/16", 7/32", 1/4"
    - 12 - Hex: 1.5, 2, 2.5, 3, 3.5, 4, 4.5, 5, 5.5, 6, 7, 8mm
    - 13 - Star: T5, T6, T7, T8, T9, T10, T15, T20, T25, T27, T30, T40, T45
    - 9 - Five Star: T10, T15, T20, T25, T27, T30, T40, T45, T50
    - 8 - Pozi: #00, #0, #1, #2 (3pc), #3, #4
    - 4 - Robertson: R0, R1, R2, R3
    - 3 - Spline: M5, M6, M8
  - 13 - 1/4" Screwdriver Bits (50mm):
    - 2 - Pozi: #2, #3
    - 3 - Torq: 6, 8, 10
    - 4 - Tri-Wing: 1, 2, 3, 4
    - 4 - Spanner: #4, #6, #8, #10
  - 13 - 1/4" Screwdriver Bits (75mm):
    - 2 - Phillips: #2, #3
    - 4 - Hex: 3, 4, 5, 6mm
    - 7 - Tamper-Proof Star: T10, T15, T20, T25, T27, T30, T40
  - 40 - 1/4" Security Screwdriver Bits (25mm):
    - 3 - Torq: 6, 8, 10
    - 3 - Clutch Bits: 1, 2, 3
    - 4 - Tri-Wing: 1, 2, 3, 4
    - 4 - Spanner: #4, #6, #8, #10
    - 6 - Tampered Hex: 5/64", 3/32", 7/64", 1/8", 9/64", 5/32"
    - 6 - Tamper-Proof Hex: 2, 2.5, 3, 4, 5, 6mm
    - 14 - Tamper-Proof Star: T5, T6, T7, T8, T9, T10, T15, T20, T25, T27, T30, T35, T40, T45
  - 1 - 1/4" Bit Holder
  - 1 - 1/4" Dr. Bit Adaptor
  - 1 - Quick-Release Bit Coupler



## T33258 21pc Bit Set

- Contents: (S2 Alloy Steel Bits)
  - 20 - 5/32" Screwdriver Bits (20mm):
    - 3 - Phillips: #000, #00, #0
    - 3 - Slotted: 0.8, 1.5, 2mm
    - 3 - Pozi: #000, #00, #0
    - 6 - Tamper-Proof Star: T6, T7, T8, T9, T10, T15
    - 5 - Hex: 0.7, 0.9, 1.3, 1.5, 2mm
    - 1 - 5/32" Precision Bit Driver: 15mm



## T33259 20pc Bit Set

- Contents: (S2 Alloy Steel Bits)
  - 19 - 1/4" Screwdriver Bits (25mm):
    - 3 - Phillips: #1, #2, #3
    - 3 - Slotted: 4.5, 5.5, 6.5mm
    - 3 - Pozi: #1, #2, #3
    - 3 - Hex: 4, 5, 6mm
    - 7 - Star: T10, T15, T20, T25, T27, T30, T40
    - 1 - 1/4" Dr. Ratchet Bit Driver



## T33720 16pc 1/4" Dr. Spline Socket & Bit Set

- Contents: (S2 Alloy Steel Bits)
  - 9 - 1/4" Screwdriver Bits (25mm):
    - 3- Phillips: #1, #2, #3
    - 3- Slotted: 3, 5, 6mm
    - 3- Hex: 3, 4, 5mm
  - 5 - 1/4" Dr. Spline Sockets: 6, 7, 8, 10, 13mm (CR-V)
  - 1 - 1/4" Dr. Bit Adaptor
  - 1 - 1/4" Dr. Ratchet Bit Driver



## T33256 37pc Bit Set

- Contents: (S2 Alloy Steel Bits)
  - 35 - 1/4" Screwdriver Bits (25mm):
    - 5 - Phillips: #1, #2 (3pc), #3
    - 7 - Slotted: 4, 4.5, 5, 5.5, 6, 6.5, 7mm
    - 5 - Pozi: #1, #2 (3pc), #3
    - 4 - Hex: 3, 4, 5, 6mm
    - 7 - Star: T10, T15, T20, T25, T27, T30, T40
    - 7 - Tamper-Proof Star: T10, T15, T20, T25, T27, T30, T40
  - 1 - 1/4" x 25mm Bit Adaptor
  - 1 - 1/4" x 65mm Quick-Release Bit Coupler



## T33721 26pc 1/4" Dr. Mini Ratchet, Spline Socket & Bit Set

- Contents: (S2 Alloy Steel Bits)
  - 18 - 1/4" Screwdriver Bits (25mm):
    - 3 - Phillips: #1, #2, #3
    - 3 - Slotted: 4, 5.5, 6.5mm
    - 3 - Pozi: #1, #2, #3
    - 4 - Hex: 3, 4, 5, 6mm
    - 5 - Star: T10, T15, T20, T25, T30
  - 5 - 1/4" Dr. Spline Sockets: 6, 7, 8, 10, 13mm
  - 1 - 1/4" Dr. Bit Adaptor
  - 1 - 1/4" Dr. Extension Bar with Hex Shaft: 50mm
  - 1 - 1/4" Dr. Mini Ratchet

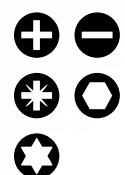



### T33254 64pc Bit Set

- Contents: (S2 Alloy Steel Bits)
  - 62 - 1/4" Screwdriver Bits (25mm):
    - 4 - Phillips: #1, #2, #3, #4
    - 8 - Slotted: 3, 4, 4.5, 5, 5.5, 6, 6.5, 8mm
    - 4 - Pozzi: #1, #2, #3, #4
    - 7 - Hex: 2, 3, 4, 5, 6, 7, 8mm
    - 8 - Star: T8, T10, T15, T20, T25, T27, T30, T40
    - 8 - Tamper-Proof Star: T8, T10, T15, T20, T25, T27, T30, T40
    - 3 - Torq: 6, 8, 10
    - 4 - Spanner: 4, 6, 8, 10
    - 4 - Tri-wing: 1, 2, 3, 4
    - 12 - Tamper Hex: 2, 2.5, 3, 4, 5, 6mm
      - 5/64", 3/32", 7/64", 1/8", 9/64", 5/32"
  - 1 - 1/4" Socket Adaptor
  - 1 - 1/4" Quick-Release Bit Coupler



### T33272 40pc Bit Set

- S2 alloy steel bit construction
- Chrome Vanadium steel bit adaptor
- Contents:
  - 7 - Star (30mm): T20, T25, T30, T40, T45, T50, T55
  - 7 - Star (75mm): T20, T25, T30, T40, T45, T50, T55
  - 5 - Spline (30mm): M5, M6, M8, M10, M12
  - 5 - Spline (75mm): M5, M6, M8, M10, M12
  - 7 - Hex (30mm): 4, 5, 6, 7, 8, 10, 12mm
  - 7 - Hex (75mm): 4, 5, 6, 7, 8, 10, 12mm
  - 1 - 3/8" Dr. Bit Adaptor
  - 1 - 1/2" Dr. Bit Adaptor



### T33271 40pc Star and E-Style Socket, Bit and Wrench Set

- Chrome Vanadium E-sockets, E4 - E20
- Industrial grade alloy steel star bits
- Complete assortment of star bits, bit sockets and wrenches
- Extended length of star bits T55 - T70
- Contents:
  - 11 - E-Sockets:
    - 1/4" Dr. - E4, E5, E6, E7, E8
    - 3/8" Dr. - E10, E12, E14, E16, E18, E20
  - 4 - 1/4" Star Bits: T9, T10, T15, T20 (30mm)
  - 6 - 3/8" Star Bits: T25, T27, T30, T40, T45, T50 (30mm)
  - 3 - 9/16" Star Bits: T55 (108mm), T60 & T70 (78mm)
  - 1 - 1/4" Dr. x 6mm Bit Holder
  - 1 - 3/8" Dr. x 10mm Bit Holder
  - 1 - 1/2" Dr. x 14mm Bit Holder
  - 13 - "L" Type Star Wrenches
    - T9, T10, T15, T20, T25, T27, T30, T40, T45, T50, T55, T60, T70
- Metal Case

## T22870 14pc 1/2" Dr. Ribe Bit Set

- Contents: (S2 Alloy Steel Bits)
  - 6 - 3/8" (10mm) Ribe Bits (38mm):  
M5, M6, M7, M8, M10, M12
  - 7 - 3/8" (10mm) Ribe Bits (100mm):  
M7, M8, M9, M10, M12, M13, M14
  - 1 - 1/2" Dr. x 10mm Bit Adaptor



## T33270 15pc 1/2" Dr. Hex Bit Set

- Contents: (S2 Alloy Steel Bits)
  - 7 - 3/8" (10mm) Hex Bits (30mm):  
4, 5, 6, 7, 8, 10, 12mm
  - 7 - 3/8" (10mm) Hex Bits (75mm):  
4, 5, 6, 7, 8, 10, 12mm
  - 1 - 1/2" Dr. x 10mm Bit Adaptor



## T33216 20pc Retractable Tapeline Bit Reel Set

- Contents: (Chrome Vanadium Steel Bits)
  - 20 - 1/4" Screwdriver Bits:
    - 3 - Phillips: #0, #1, #2
    - 3 - Slotted: 5/32", 3/16", 1/4", 4, 5, 6mm
    - 3 - Pozzi: #0, #1, #2
    - 4 - Hex: 1/8", 5/32", 3/16", 1/4", 3, 4, 5, 6mm
    - 6 - Star: T10, T15, T20, T25, T27, T30
    - 1 - Square: S2



## T33726 27pc Stubby Ratchet & Bit Set

- Contents: (S2 Alloy Steel Bits)
  - 25 - 10mm Screwdriver Bits (30mm):
    - 2 - Phillips: #2, #3
    - 7 - Hex: 4, 5, 6, 7, 8, 10, 12mm
    - 7 - Star: T20, T25, T30, T40, T45, T50, T55
    - 5 - Spline: M5, M6, M8, M10, M12
    - 4 - Ribe: M6, M8, M10, M12
  - 1 - 10mm Hex Stubby Ratchet
  - 1 - 10mm Extension Bar





### T12291 20pc Bit Set with Key Chain

- Contents: (S2 Alloy Steel Bits)
- 15 - 1/4" Screwdriver Bits (25mm):
  - 3 - Phillips: #1, #2, #3
  - 4 - Slotted: 4, 5, 6, 7mm
  - 3 - Pozi: #1, #2, #3
  - 5 - Star: T10, T15, T20, T25, T30
- 1 - 54mm Stainless Steel Bit Holder
- 1 - 60mm #3 Drill
- 2 - Power Nut w/ Magnetic 45mm: 1/4", 8mm
- 1 - Adaptor



### T12292 20pc Bit Set with Key Chain

- Contents: (S2 Alloy Steel Bits)
- 15 - 1/4" Screwdriver Bits (25mm):
  - 3 - Phillips: #1, #2, #3
  - 4 - Slotted: 4, 5, 6, 7mm
  - 3 - Pozi: #1, #2, #3
  - 5 - Star: T10, T15, T20, T25, T30
- 1 - 75mm Bit Phillip: #2
- 1 - 52mm Quick-Release Magnetic Bit Coupler
- 2 - Power Nut w/ Magnetic 45mm: 1/4", 8mm
- 1 - Adaptor



### T12293 22pc Bit Set with Key Chain

- Contents: (S2 Alloy Steel Bits)
- 19 - 1/4" Screwdriver Bits (25mm):
  - 3 - Phillips: #1, #2, #3
  - 5 - Slotted: 4, 5, 6, 7, 8mm
  - 3 - Pozi: #1, #2, #3
  - 2 - Hex: 5, 6mm
  - 6 - Star: T10, T15, T20, T25, T30, T40
- 1 - 50mm Bit Phillip: #2
- 1 - 50mm Bit Holder
- 1 - Adaptor



### T33290 10pc Double-End Power Bit Set

- Chrome Vanadium steel
- 10 Double-ended Phillips #2 & Pozi #2 bits w/ magnetic tip
- Ideal for use with power screwdrivers and drills



### T33292 10pc Double-End Power Bit Set

- Chrome Vanadium steel
- 10 Double-ended Phillips #2 & Slotted 6mm bits w/ magnetic tip
- Ideal for use with power screwdrivers and drills



### T32101 1/4" Micro Ratcheting Bit Driver

- Chrome Vanadium steel
- Forward / Reversible lever construction
- Ideal for fitting 1/4" hex bits



### T33265 Quick-Release Bit Coupler

### T33269 One-Touch Quick Release Magnetic Bit Coupler



\* Bit is not included



### T33268 Flexible Bit Driver

- Contents:
  - 1 - 1/4" Universal Bit Driver
  - 10 - 1/4" Screwdriver Bits:
    - 3 - Phillips: #1, #2, #3
    - 7 - Star: T10, T15, T20, T25, T27, T30, T40

#### Flex Design for Hard-to-Reach Areas



### Power Nut Bit w/ Magnet

- Chrome Vanadium steel

Model	Size	Model	Size
T12300	1/4" x 45mm	T12306	7mm x 45mm
T12301	5/16" x 45mm	T12307	8mm x 45mm
T12302	3/8" x 45mm	T12308	10mm x 45mm
T12303	7/16" x 45mm	T12309	11mm x 45mm
T12304	8mm x 45mm	T12310	12mm x 45mm
T12305	6mm x 45mm	T12311	13mm x 45mm



### Bit Adaptor

- Chrome Vanadium steel with shot blast finish
- Spring-loaded ball bearing for secure socket holding



Model	Size
T12006	1/4" x 65mm
T12007	3/8" x 65mm
T12008	1/2" x 65mm

### Bit Holder

- Chrome Vanadium steel
- Spring clip and ball bearing for secure bit holding



Model	Size
T12000	1/2" Dr. x 5/16" (10mm)
T12001	3/8" Dr. x 5/16" (10mm)
T12002	3/8" Dr. x 1/4" (6mm)

### T12003 1/4" Dr. x 1/4" (6mm) Bit Holder

- Chrome Vanadium steel
- Spring clip and ball bearing for secure bit holding

### T12004 1/4" Extended Bit Holder

- 1/4" (M) x 1/4" (F) Magnetic bit holder for use in power drills and driver handles



### T12290 7pc Bit Set

- Contents: (S2 Alloy Steel Bits)
  - 2 - Phillips: #1, #2
  - 2 - Slotted: 0.8, 1.2mm
  - 2 - Pozi: #1, #2
  - 1 - 1/4" Dr. Bit Holder





## 1/4" Bits

- S2 Alloy Steel Bits



Model	Size	Qty
<b>T12010</b>	⊕ #0 (25mm)	3pc/Set
<b>T12011</b>	⊕ #1 (25mm)	3pc/Set
<b>T12012</b>	⊕ #2 (25mm)	3pc/Set
<b>T12013</b>	⊕ #3 (25mm)	3pc/Set

Model	Size	Qty
<b>T12021</b>	⊛ #1 (25mm)	3pc/Set
<b>T12022</b>	⊛ #2 (25mm)	3pc/Set
<b>T12023</b>	⊛ #3 (25mm)	3pc/Set

Model	Size	Qty
<b>T12043</b>	⊙ 3 (25mm)	3pc/Set
<b>T12044</b>	⊙ 4 (25mm)	3pc/Set
<b>T12045</b>	⊙ 5 (25mm)	3pc/Set
<b>T12047</b>	⊙ 6 (25mm)	3pc/Set
<b>T12048</b>	⊙ 7 (25mm)	3pc/Set
<b>T12049</b>	⊙ 8 (25mm)	3pc/Set
<b>T12050</b>	⊙ 10 (25mm)	3pc/Set

Model	Size	Qty
<b>T12067</b>	⊠ S1 (25mm)	3pc/Set
<b>T12068</b>	⊠ S2 (25mm)	3pc/Set

Model	Size	Qty
<b>T12027</b>	⊖ 4 (25mm)	3pc/Set
<b>T12029</b>	⊖ 5 (25mm)	3pc/Set
<b>T12030</b>	⊖ 5.5 (25mm)	3pc/Set
<b>T12033</b>	⊖ 7 (25mm)	3pc/Set
<b>T12034</b>	⊖ 8 (25mm)	3pc/Set

Model	Size	Qty
<b>T12055</b>	⊛ T5 (25mm)	3pc/Set
<b>T12056</b>	⊛ T6 (25mm)	3pc/Set
<b>T12057</b>	⊛ T7 (25mm)	3pc/Set
<b>T12058</b>	⊛ T8 (25mm)	3pc/Set
<b>T12060</b>	⊛ T10 (25mm)	3pc/Set
<b>T12061</b>	⊛ T15 (25mm)	3pc/Set
<b>T12062</b>	⊛ T20 (25mm)	3pc/Set
<b>T12063</b>	⊛ T25 (25mm)	3pc/Set
<b>T12064</b>	⊛ T27 (25mm)	3pc/Set
<b>T12065</b>	⊛ T30 (25mm)	3pc/Set
<b>T12066</b>	⊛ T40 (25mm)	3pc/Set

## 1/4" Long Bits

- S2 Alloy Steel Bits



Model	Size
<b>T12265</b>	⊕ #1 (90mm)
<b>T12266</b>	⊕ #2 (90mm)
<b>T12267</b>	⊕ #3 (90mm)
<b>T12268</b>	⊕ #1 (152mm)
<b>T12269</b>	⊕ #2 (152mm)
<b>T12270</b>	⊕ #3 (152mm)

Model	Size
<b>T12271</b>	⊛ #1 (90mm)
<b>T12272</b>	⊛ #2 (90mm)
<b>T12273</b>	⊛ #3 (90mm)
<b>T12274</b>	⊛ #1 (152mm)
<b>T12275</b>	⊛ #2 (152mm)
<b>T12276</b>	⊛ #3 (152mm)





# Professional Pliers

Quality to Depend on





## High Leverage Pliers

High Leverage pliers boast a labor-saving design to generate greater productivity with less effort. Ergonomic soft-grip handles allow for a larger load surface to increase comfort, reduce user fatigue and increase leverage when cutting large diameter wires.

### High Leverage Mini Long Nose Pliers



Model	Size
<b>T28580</b>	5" 125mm

### High Leverage Mini Diagonal Cutting Pliers



Model	Size
<b>T28581</b>	5" 125mm

### High Leverage Mini Combination Pliers



Model	Size
<b>T28582</b>	5" 125mm

### High Leverage Long Nose Pliers



Model	Size
<b>T28586</b>	7-1/2" 190mm

### High Leverage Diagonal Cutting Pliers



Model	Size
<b>T28587</b>	7-1/2" 190mm

### High Leverage Combination Pliers



Model	Size
<b>T28588</b>	7-1/2" 190mm



### T28591 3pc High Leverage Mini Pliers Set

- Contents:
  - 1 - 5" (125mm) High Leverage Mini Long Nose Pliers
  - 1 - 5" (125mm) High Leverage Mini Diagonal Cutting Pliers
  - 1 - 5" (125mm) High Leverage Mini Combination Pliers

### T28592 3pc High Leverage Pliers Set

- Contents:
  - 1 - 7-1/2" (190mm) High Leverage Long Nose Pliers
  - 1 - 7-1/2" (190mm) High Leverage Diagonal Cutting Pliers
  - 1 - 7-1/2" (190mm) High Leverage Combination Pliers

## High Leverage Pliers

High Leverage pliers boast a labor-saving design to generate greater productivity with less effort. Ergonomic soft-grip handles allow for a larger load surface to increase comfort, reduce user fatigue and increase leverage when cutting large diameter wires.

### Long Nose Pliers

- High leverage design
- Chrome Molybdenum steel
- Half-round serrated jaws
- Side cutter



Model	Size
<b>T28506</b>	6" 150mm
<b>T28508</b>	8" 200mm

### Bent Nose Pliers

- High leverage design
- Chrome Molybdenum steel
- Half-round serrated jaws
- Side cutter



Model	Size
<b>T28511</b>	6" 150mm
<b>T28512</b>	8" 200mm

### Diagonal Cutting Pliers

- High leverage design
- Chrome Molybdenum steel
- Extra-hardened cutting edges great for cutting wires
- Inset joint



Model	Size
<b>T28516</b>	6" 150mm

### Heavy Duty Cutting Pliers

- High leverage design
- Chrome Molybdenum steel
- Extra-hardened cutting edges with high-frequency treatment ensures high strength and long life
- Scissors joint



Model	Size
<b>T28527</b>	7" 180mm

### Combination Pliers

- High leverage design
- Chrome Molybdenum steel
- Half-round serrated jaws
- Side cutter



Model	Size
<b>T28546</b>	6" 150mm
<b>T28547</b>	7" 180mm
<b>T28548</b>	8-1/2" 215mm

### Water Pump Pliers

- Chrome Molybdenum steel
- Serrated jaws over its full length
- 7 settings for flexible adjustment
- Position engagement for high power



Model	Size
<b>T28571</b>	9-1/2" 240mm





T28396



T28395

### T28396 2pc Professional Pliers Set

- Contents:
  - 1 - 8-1/2" (215mm) High Leverage Combination Pliers
  - 1 - 9-1/2" (240mm) Water Pump Pliers

### T28395 3pc Pliers Set

- Contents:
  - 6" (150mm) High Leverage Diagonal Pliers
  - 7" (180mm) High Leverage Combination Pliers
  - 9-1/2" (240mm) Water Pump Pliers

## Double Leverage - Less Effort Pliers

- Double high-leverage design adds 60% more power
- Uses a unique high frequency process for cutting edges
- 30% enlarged grip surface for easy and comfortable handling
- Smoothly ground heads with serrated jaws for cutting hard and piano wires
- Precision-machined and induction-hardened blades strengthen cutters and provide consistent performance

14



Adds 60% More Power

Double Leverage Construction

### High Leverage Long Nose Pliers

- 60% Less effort required during application



Model	Size
T28551	8-1/2" 215mm

### High Leverage Combination Pliers

- 60% Less effort required during application



Model	Size
T28552	8" 200mm

### High Leverage Diagonal Cutting Pliers

- 60% Less effort required during application



Model	Size
T28553	7" 180mm



## Long Reach High Leverage Pliers

- Drop forged from chrome vanadium steel for greater durability and strength
- High leverage pliers design and serrated jaws for optimum cutting and gripping performance
- Ergonomic molded grips for increased comfort and reduced user fatigue
- Effectively cuts hardened wire, bolts, screws, and nails

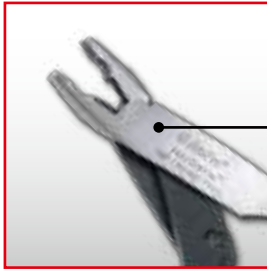

45-50% More Gripping and Cutting Power

High Leverage Construction

## High Leverage Long Nose Pliers

- Precision-forged jaws for positive clamping
- Equipped with side cutter



Model

Size

T28770

9" 230mm

## High Leverage Diagonal Cutting Pliers

- Hardened, tempered cutting edges
- Equipped with long-reach shaft



Model

Size

T28771

8-1/2" 215mm

## High Leverage Lineman's Pliers

- Specially hardened jaws
- Equipped with side cutter



Model

Size

T28772

8-1/2" 215mm

## T28958 3pc High Leverage Pliers Set

- Contents:
  - 1 - 8-1/2" (215mm) Diagonal Cutting Pliers
  - 1 - 8-1/2" (215mm) Linesman Pliers
  - 1 - 9" (230mm) Long Nose Pliers





### Long Nose Pliers

- Chrome Vanadium steel
- Half-round serrated jaws
- Side cutter



Model	Size
T29006	6" 150mm
T29008	8" 200mm

### Slip Joint Pliers

- Chrome Vanadium steel
- Slim nose with twin-notch slot for extended capacity
- Serrated jaws for added strength



Model	Size
T29056	6" 150mm
T29057	8" 200mm

### End Nipper

- Traditional design featuring wide cutting edges
- Double-hardened cutting edges
- Ideal for ripping and cutting wires



Model	Size
T29021	6" 150mm
T29022	8" 200mm

### Heavy Duty Cutting Pliers

- Chrome Vanadium steel
- Extra-hardened cutting edges with high-frequency treatment ensures high strength and long life



Model	Size
T29027	7" 180mm

### Combination Pliers

- Chrome Vanadium steel
- Half-round serrated jaws
- Side cutter
- Precision machined joint



Model	Size
T29046	6" 150mm
T29047	7" 180mm
T29048	8" 200mm

### Diagonal Cutting Pliers

- Chrome Vanadium steel
- Extra-hardened cutting edges great for cutting wires
- Inset joint



Model	Size
T29015	5" 125mm
T29016	6" 150mm
T29017	7" 180mm

### Groove Joint Pliers

- Chrome Vanadium steel
- Serrated jaws over its full length
- Positive engagement for high power



Model	Size
T29070	10" 250mm
T29071	12" 305mm

### Box Joint Water Pump Pliers

- Chrome Vanadium steel
- Serrated jaws over its full length
- Positive engagement for high power



Model	Size
T29060	10" 250mm



### T29090 3pc Professional Pliers Set

- Contents:
  - 1 - 6" (150mm) Long Nose Pliers
  - 1 - 6" (150mm) Slip Joint Pliers
  - 1 - 6" (150mm) Diagonal Pliers



### T29091 3pc Professional Pliers Set

- Contents:
  - 1 - 8" (200mm) Long Nose Pliers
  - 1 - 7" (180mm) Heavy Duty Diagonal Pliers
  - 1 - 7" (180mm) Combination Pliers



### T29092 4pc Professional Pliers Set

- Contents:
  - 1 - 6" (150mm) Long Nose Pliers
  - 1 - 6" (150mm) Diagonal Pliers
  - 1 - 7" (180mm) Combination Pliers
  - 1 - 10" (250mm) Box Joint Water Pump Pliers



### T29093 3pc Professional Pliers Set

- Contents:
  - 1 - 6" (150mm) Combination Pliers
  - 1 - 6" (150mm) Adjustable Wrench
  - 1 - 7" (180mm) Locking Pliers



### T29094 4pc Professional Pliers Set

- Contents:
  - 1 - 6" (150mm) Long Nose Pliers
  - 1 - 6" (150mm) Diagonal Pliers
  - 1 - 7" (180mm) Locking Pliers
  - 1 - 10" (250mm) Box Joint Water Pump Pliers



### T28394 3pc Professional Pliers Set

- Contents:
  - 1 - 8" (200mm) Adjustable Wrench
  - 1 - 10" (250mm) Lock Grip Pliers
  - 1 - 10" (250mm) Groove Joint Pliers



**Diagonal Cutting Pliers**

- Chrome Vanadium steel
- Extra-hardened cutting edges great for cutting wires
- Inset joint



Model	Size
<b>T28816</b>	6" 150mm
<b>T28817</b>	7" 180mm

**Heavy Duty Cutting Pliers**

- Chrome Vanadium steel
- Extra-hardened cutting edges great for cutting wires
- Scissors joint



Model	Size
<b>T28827</b>	7" 180mm

**Long Nose Pliers**

- Chrome Vanadium steel
- Half-round serrated jaws
- Side cutter



Model	Size
<b>T28806</b>	6" 150mm
<b>T28808</b>	8" 200mm

**Combination Pliers**

- Chrome Vanadium steel
- Half-round serrated jaws
- Side cutter
- Precision machined joint



Model	Size
<b>T28846</b>	6" 150mm
<b>T28847</b>	7" 180mm
<b>T28848</b>	8" 200mm

**14**
**Long Nose Pliers**

- Chrome Vanadium steel
- Side cutter



Model	Size
<b>T28305</b>	5" 125mm
<b>T28306</b>	6" 150mm
<b>T28308</b>	8" 200mm

**Heavy Duty Cutting Pliers**

- Chrome Vanadium steel
- Extra-hardened cutting edges ensure high strength and long life
- Scissors joint



Model	Size
<b>T28327</b>	7" 180mm

**Diagonal Cutting Pliers**

- Chrome Vanadium steel
- Extra-hardened cutting edges great for cutting wires
- Inset joint



Model	Size
<b>T28315</b>	5" 125mm
<b>T28316</b>	6" 150mm
<b>T28317</b>	7" 180mm

**Lineman's Pliers**

- Chrome Vanadium steel
- Precision machined joint
- Side cutter



Model	Size
<b>T28336</b>	6" 150mm Heavy Duty
<b>T28337</b>	7" 180mm Heavy Duty
<b>T28338</b>	8" 200mm Heavy Duty

## Slip Joint Pliers

- Chrome Vanadium steel
- Slim nose with twin-notch slot for extended capacity
- Ideal tool for automotive applications



Model	Size
<b>T28356</b>	6" 150mm
<b>T28358</b>	8" 200mm

## Box Joint Water Pump Pliers

- Chrome Vanadium steel
- Serrated jaws over its full length
- 7 settings for flexible adjustment
- Position engagement for high power



Model	Size
<b>T28675</b>	10" 250mm

## Carpenter's Pincers

- Specially favoured by craftsmen due to precision workmanship
- Extremely wear-resistant and good balance
- Hardened and tempered, Chrome Vanadium steel



Model	Size
<b>T28330</b>	9" 230mm
<b>T28331</b>	10" 250mm

## Fence Pliers

- Side cutters to cut soft wire
- One side of head designed to hammer, the other side to dig
- Nail-pulling design



Model	Size
<b>T28332</b>	10" 250mm

## End Nipper

- Traditional design featuring wide cutting edges
- Double-hardened cutting edges
- Ideal for ripping and cutting wires



Model	Size
<b>T28321</b>	6" 150mm
<b>T28322</b>	8" 200mm

## Groove Joint Pliers

- Chrome Vanadium steel
- Serrated jaws over its full length
- Positive engagement for high power
- 5 settings, flexible adjustment



Model	Size
<b>T28370</b>	8" 200mm
<b>T28371</b>	10" 250mm
<b>T28372</b>	12" 305mm
<b>T28373</b>	16" 406mm





## Offset Pliers



Extra Hardened Cutting Edges



7" / 180mm  
Offset Diagonal Cutting Pliers

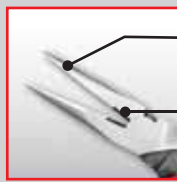

Precision-Forged Jaws for Positive Clamping

Side Cutter



8" / 200mm  
Offset Long Nose Pliers



Wire Cutter



8" / 200mm  
Offset Slip Joint Pliers

- Chrome Vanadium steel
- Offset shaft for precise cutting and maximum reach
- Cushioned grip handle for extra leverage and comfort



Maximum Reach

Offset Shaft Design

### Offset Diagonal Cutting Pliers

- Extra hardened cutting edges



Model	Size
T28760	7" 180mm

### Offset Long Nose Pliers

- Equipped with convenient side cutter



Model	Size
T28761	8" 200mm

### Offset Slip Joint Pliers

- Equipped with wire cutting capability



Wire Cutter

Model	Size
T28762	8" 200mm

### T28967 2pc Offset Pliers Set

- Contents:
  - 1 - 7" (180mm) Offset Diagonal Cutting Pliers
  - 1 - 8" (200mm) Offset Long Nose Pliers



### T28957 3pc Offset Pliers Set

- Contents:
  - 1 - 7" (180mm) Offset Diagonal Cutting Pliers
  - 1 - 8" (200mm) Offset Long Nose Pliers
  - 1 - 8" (200mm) Offset Slip Joint Pliers





## Arched Handle Pliers

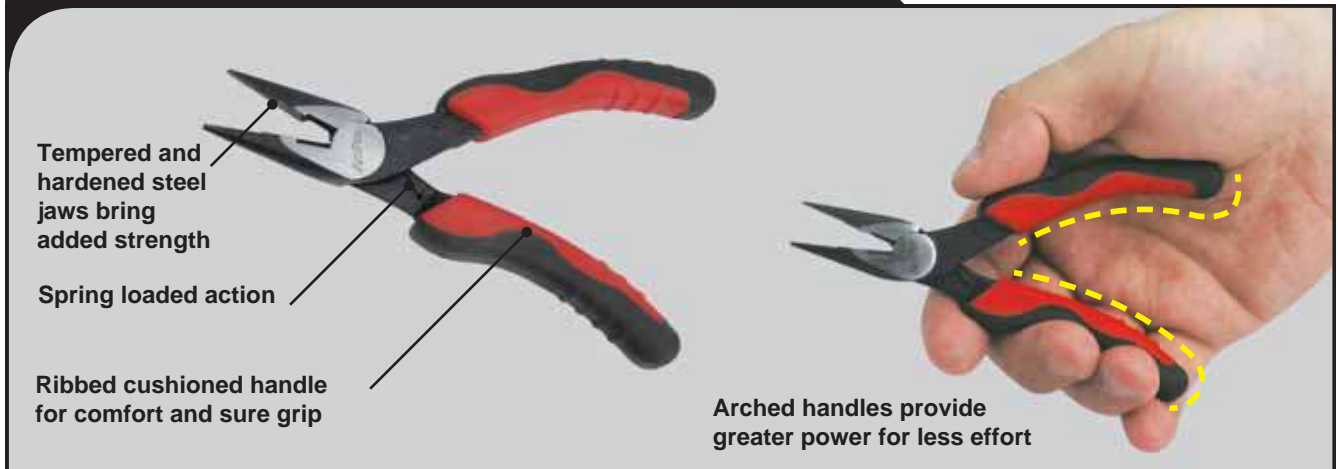

### Arched Diagonal Pliers



Model	Size
T28854	6-1/2" 165mm

### Arched Long Nose Pliers



Model	Size
T28851	6-1/2" 165mm

### Arched Linesman Pliers



Model	Size
T28856	6-1/2" 165mm

### Arched Mini Diagonal Pliers



Model	Size
T28853	5" 125mm

### Arched Mini End Nipper Pliers



Model	Size
T28857	5" 125mm

### Arched Mini Linesman Pliers



Model	Size
T28855	5" 125mm



## Arched Mini Long Nose Pliers



Model	Size
<b>T28850</b>	5" 125mm

## Arched Mini Bent Nose Pliers



Model	Size
<b>T28852</b>	5" 125mm

## Arched Quick Release Slip Joint Pliers

- Arched handle design adds more leverage and comfort
- Quick release button for fast change of jaw opening
- Chrome Vanadium steel
- Tempered, hardened jaw for added strength

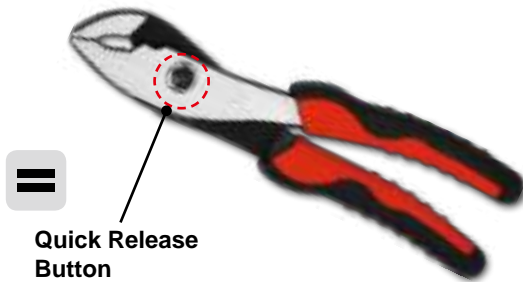

Model	Size
<b>T28866</b>	8" 200mm

## T28741 5pc Mini Pliers & Pickup Tool Set

- Contents:
  - 1 - 5-1/2" (140mm) Long Reach End Nipper Pliers
  - 1 - 6" (150mm) Long Reach Diagonal Cutting Pliers
  - 1 - 6-1/2" (165mm) Long Reach Long Nose Pliers
  - 1 - 6-1/2" (165mm) Long Reach Bent Nose Pliers
  - 1 - Magnetic Pickup



## T28956 3pc Arched Handle Pliers Set

- Arched handle for comfort, more power and less effort
- Chrome Vanadium steel
- Spring loaded design
- Hardened, tempered jaws
- Contents:
  - 1 - 6-1/2" (165mm) Long Nose Pliers,
  - 1 - 6-1/2" (165mm) Linesman Pliers,
  - 1 - 6-1/2" (165mm) Diagonal Pliers



## T28959 5pc Arched Handle Mini Pliers Set

- Arched handle for comfort, more power and less effort
- Chrome Vanadium steel
- Spring loaded design
- Hardened, tempered jaws
- Contents:
  - 1 - 5" (125mm) Bent Nose Pliers,
  - 1 - 5" (125mm) Long Nose Pliers,
  - 1 - 5" (125mm) End Nipper,
  - 1 - 5" (125mm) Linesman Pliers,
  - 1 - 5" (125mm) Diagonal Pliers





## Long Reach Pliers

- Long handles and nose allow greater access to hard-to-reach areas
- Long-reach design provides greater holding power at the tip w/ minimal effort
- Mating surfaces and dimensions are precision machined for faultless tool performance
- Knurled jaws for precise gripping, sure wrapping and looping of wire
- Nose is bent 45° or 90° to reach around obstructions
- 5/16", 1/2" and 3/4" hose grip sizes

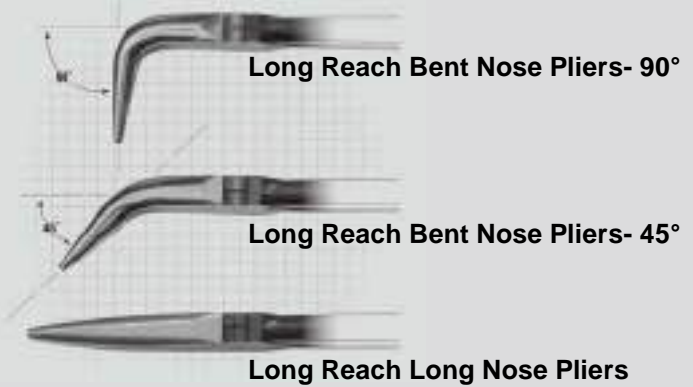

### Long Reach Long Nose Pliers



Model	Size
<b>T28350</b>	11" 280mm

### Long Reach Hose Grip Pliers



Model	Size
<b>T28353</b>	11" 280mm

### Long Reach Bent Nose Pliers



Model	Size
<b>T28351</b>	11" 280mm (45 Degree)

### Long Reach Hose Grip Pliers



Model	Size
<b>T28354</b>	11" 280mm

### Long Reach Bent Nose Pliers



Model	Size
<b>T28352</b>	11" 280mm (90 Degree)

### Long Reach Hose Grip Pliers



Model	Size
<b>T28355</b>	11" 280mm



## Adjustable Water Pump Pliers

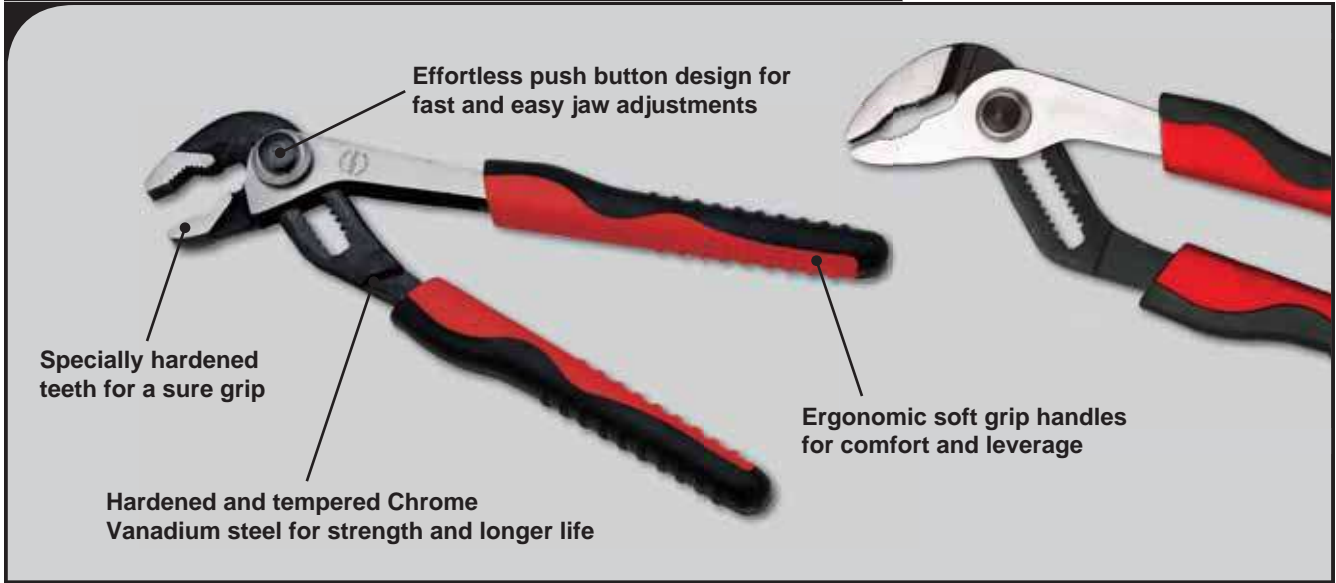

### Adjustable Box Joint Pliers

### Adjustable Groove Joint Pliers

14



Model	Size
T28860	8" 200mm
T28861	10" 250mm

Model	Size
T28863	8" 200mm
T28864	10" 250mm

### T28960 2pc Adjustable Box Joint Pliers Set

### T28961 2pc Adjustable Groove Joint Pliers Set

- 8" (200mm) & 10" (250mm)

- 8" (200mm) & 10" (250mm)





## Snap Ring Pliers

	Model	Size
(A)	<b>T73331</b>	7" 180mm Straight Nose Internal Pliers
	<b>T73351</b>	9" 230mm Straight Nose Internal Pliers
(B)	<b>T73332</b>	7" 180mm Bent Nose Internal Pliers
	<b>T73352</b>	9" 230mm Bent Nose Internal Pliers
(C)	<b>T73333</b>	7" 180mm Straight Nose External Pliers
	<b>T73353</b>	9" 230mm Straight Nose External Pliers
(D)	<b>T73334</b>	7" 180mm Bent Nose External Pliers
	<b>T73354</b>	9" 230mm Bent Nose External Pliers

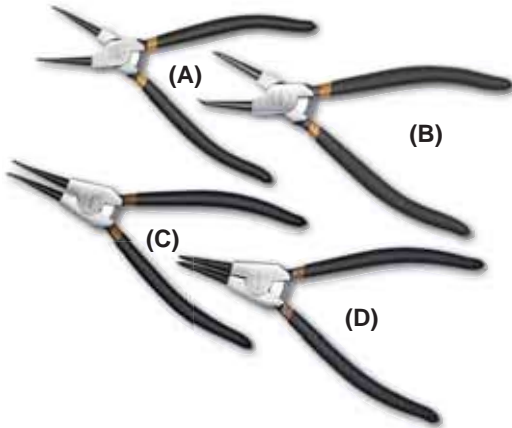

## T73339 External Snap Ring Pliers

- For E-Clip from 1/8" (3mm) to 1/2" (12mm)
- Length: 6-1/2" (165mm)



## Adjustable Internal / External Snap Ring Pliers

- Heavy duty construction
- Chrome Molybdenum steel for strength and durability
- Spring loaded for easy operation
- Tapered tips for 180°, 45° and 90° use
- Tip size:
  - 1.2mm, 1.4mm, 2.0mm for T73336, T73337
  - 0.8mm, 1.2mm, 1.4mm, 2.0mm for T73338

Model	Size
<b>T73336</b>	6-1/2" 165mm (Internal)
<b>T73337</b>	6-1/2" 165mm (External)
<b>T73338</b>	2pc Adjustable Snap Ring Pliers Set (Internal & External)



## T73330 4pc Mini Snap Ring Pliers Set

- Chrome Molybdenum steel for strength and durability
- Spring loaded for easy operation
- Ideal for easy access in confined areas
- Combination set of internal, external, bent, and straight ring pliers



## T73310 5pc Internal / External Snap Ring Pliers

- Spring retainer attaches tip assemblies for conversion of internal and external use
- Consists of 1 handle and 4 tip assemblies:
  - 1 - 45-degree, 1 - 90-degree, and 2 - Straight







### T28538 6" (150mm) Wire Stripper Pliers

- Easily adjust knurled screw for required diameter of solid or stranded wire
- Spring-loaded design
- Chrome Molybdenum steel
- Capacity: 1.5mm



### T15801 Auto Wire Stripper

- Adjustable stripping length guide provides consistent uniform strip length
- AWG sizes clearly marked at each cutting station
- Die cast body and frame provides durability and strength



### T15803 8" (210mm) Auto Wire Stripper & Cutter

- Adjustable micro swivel knob counter-clockwise to strip wire 30AWG (0.05mm<sup>2</sup>) without damage the inner cord
- Steel construction provides durability and rust resistance
- Adjusts to easily strip wire to various lengths
- Strips & cuts most kinds of 8 to 26-gauge (0.13-8mm<sup>2</sup>)
- Crimps 10-22AWG (0.5-6mm<sup>2</sup>) insulated terminals, 10-22AWG non-insulated terminals & 7 to 8mm ignition terminals



### T15800 Wire Stripper & Cutter

- 2-in-1 Wire stripper & cutter
- Self-adjusting wire size mechanism
- Simple adjustment dial for blade pressure according to insulation thickness
- Wire stripper size: 0.5mm<sup>2</sup> ~ 6mm<sup>2</sup>



### T71015 8-1/2" (215mm) Wire Crimper

- Crimps insulated terminals and slices bolts
- Cuts and strips wires from 10 to 22 gauge
- Insulated handle protects from accidental shocks



### Electronic Pliers



### T15802 6" (150mm) Multi-Purpose Wire Stripper / Cutter

- For 10-20 gauge wire, serrated jaws for bending or pulling wire
- Spring loaded, curved plastic dipped handles
- For easy cutting and stripping applications



Model	Size
(A) <b>T28700</b>	5" 125mm Side Cutting Pliers
(B) <b>T28701</b>	5-1/2" 140mm Round Nose Pliers
(C) <b>T28702</b>	6" 150mm Long Nose Pliers
(D) <b>T28703</b>	6" 150mm Bent Nose Pliers
(E) <b>T28704</b>	6" 150mm Wire Stripper
(F) <b>T28705</b>	6" 150mm Wire Stripper



## Electronic Mini Pliers

- Electronics work requires extreme precision and the highest quality levels, both qualities which are represented in the AmPro electronic pliers range

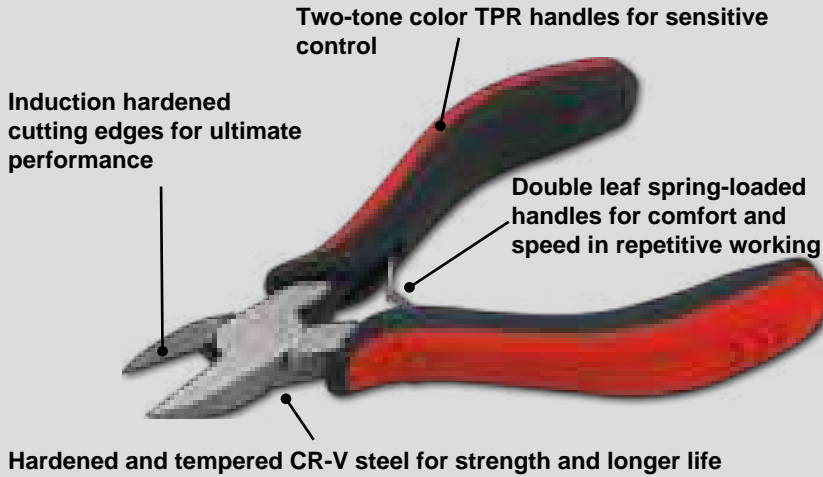

### Long Nose Pliers

- Two tone color TPR handle



Model	Size
T28749	6" 150mm

### Bent Needle Nose Pliers

- Bent nose with 45-degree slant for easy operation in complicated working space



Model	Size
T28750	6" 150mm

### Mini Diagonal Side Cutters

- For wires below 1.3mm
- Thin cutting edge



Model	Size
T28745	5" 125mm

### Diagonal Side Cutting Pliers

- Suitable for soft wire below diameter 1.2mm
- Do not use to cut steel wires



Model	Size
T28746	5" 125mm

### Mini End Cutting Pliers

- End nipper is perfect for cutting close to objects



Model	Size
T28748	5" 125mm

### Heavy Side Cutting Pliers

- Suitable for copper wire below diameter 1.2mm
- Do not use to cut steel wires



Model	Size
T28747	4-1/2" 115mm



## Insulated Pliers & Nut Drivers

AmPro fully insulated tools manufactured to DIN Standard and the European EN60900 IEC 900 standard for guaranteed electrical safety up to 1000V AC. All AmPro pliers are individually tested to 10,000V AC and stamped and certified for conformance.

Hardened and tempered Chrome Vanadium steel for strength and durability

Induction hardened cutting edges for the ultimate performance

Slip guards prevent hands from slipping onto live conductors

Ergonomic soft grip for comfort and leverage



### Insulated Long Nose Pliers



Model	Size
T28450	6" 150mm
T28451	8" 200mm

### Insulated Diagonal Cutting Pliers



Model	Size
T28452	6" 150mm
T28453	7" 165mm

### Insulated Combination Pliers



Model	Size
T28454	6" 150mm
T28455	7" 165mm
T28456	8" 200mm

### Insulated Wire Stripper



Model	Size
T28457	6" 150mm



## T28482 7pc Insulated Tool Set w/ Nylon Bag

- Contents:
  - 1 - 180mm Combination Pliers
  - 1 - 160mm Diagonal Cutting Pliers
  - 4 - VDE Screwdrivers:
    - 2 - Slotted: 3.0 x 100mm, 4.0 x 100mm
    - 1 - Phillips: #1 x 80mm
    - 1 - Pozi: #1 x 80mm
  - 1 - Cable Shears (Electrician's Shears)

**1000V**



## T28481 9pc Insulated Pliers & Screwdrivers Set

- Contents:
  - 1 - 180mm Combination Pliers
  - 1 - 160mm Diagonal Cutting Pliers
  - 1 - 200mm Long Nose Pliers
  - 5 - VDE Screwdrivers:
    - 3 - Slotted: 3.0 x 75mm, 4.0 x 100mm, 5.5 x 125mm
    - 1 - Phillips: #1 x 100mm
    - 1 - Pozi: #2 x 100mm
  - 1 - Voltage Tester 120~250V
  - 1 - Insulation Tape
  - 1 - Foldable Electrician's Knife

**1000V**



**14**

## T28470 4pc Insulated Pliers Set

- Contents:
  - 1 - 180mm Combination Pliers
  - 1 - 160mm Diagonal Cutting Pliers
  - 1 - 200mm Long Nose Pliers
  - 1 - 160mm Wire Stripping Pliers

**1000V**



## T28480 7pc Insulated Pliers & Screwdrivers Set

- Contents:
  - 1 - 180mm Combination Pliers
  - 1 - 160mm Diagonal Cutting Pliers
  - 4 - VDE Screwdrivers:
    - 2 - Phillips: #1 x 80mm, #2 x 100mm
    - 2 - Slotted: 4.0 x 100mm, 5.5 x 125mm
  - 1 - Voltage Tester 120~250V

**1000V**





### Long Nose Lock Pliers w/ Grip

- Chrome Molybdenum steel jaws
- Push lever for quick unclamping
- Extra cushioned handle for added comfort and grip



Model	Size
<b>T28375</b>	6" 150mm
<b>T28376</b>	9" 230mm

### Lock Grip Pliers w/ Grip

- Chrome Molybdenum steel jaws
- Push lever for quick unclamping
- Extra cushioned handle for added comfort and grip



Model	Size
<b>T28378</b>	5" 125mm
<b>T28379</b>	7" 180mm
<b>T28380</b>	10" 250mm

### Lock C-Clamp Pliers w/ Grip

- Chrome Vanadium steel jaws
- Push lever for quick unclamping
- Extra cushioned handle for added comfort and grip



Model	Size
<b>T28387</b>	6" 150mm
<b>T28388</b>	11" 280mm
<b>T28389</b>	18" 450mm

### Lock Grip Pliers

- Cushioned handle for secure grip & comfort
- Chrome Molybdenum steel
- Black oxide finish



Model	Size
<b>T28870</b>	5" 125mm
<b>T28871</b>	7" 180mm
<b>T28872</b>	10" 250mm

14

### Long Nose Lock Grip Pliers

- Chrome Vanadium steel
- Release lever for simple unclamping



Model	Size
<b>T28361</b>	6" 150mm
<b>T28362</b>	9" 230mm

### T28962 3pc Comfort-Grip Locking Pliers Set

- 5" (125mm), 7" (180mm) and 10" (250mm) lock grip pliers
- Cushioned handles for firm grip & comfort
- Chrome Molybdenum steel
- Black oxide finish
- Hardened jaws for high-wear resistance



### Lock Grip Pliers

- Chrome Vanadium steel
- Release lever for simple unclamping



Model	Size
<b>T28365</b>	5" 125mm
<b>T28367</b>	7" 180mm
<b>T28369</b>	10" 250mm

## Lock Grip Pliers (Curved Jaws)

- Chrome Molybdenum steel jaws
- Push lever for quick unclamping



Model	Size
<b>T28257</b>	5" 125mm
<b>T28258</b>	7" 180mm
<b>T28259</b>	10" 250mm

## Locking Pliers (Straight Jaws)

- Chrome Molybdenum steel jaws
- Push lever for quick unclamping



Model	Size
<b>T28261</b>	7" 180mm
<b>T28262</b>	10" 250mm

## Long Nose Locking Pliers

- Chrome Molybdenum steel jaws
- Push lever for quick unclamping



Model	Size
<b>T28255</b>	6" 150mm
<b>T28256</b>	9" 230mm

## Long Nose Lock Grip Pliers

- Chrome Molybdenum steel jaws
- Release lever for simple unclamping



Model	Size
<b>T28340</b>	6" 150mm
<b>T28341</b>	9" 230mm

## Larger Jaw Pliers

- Chrome Molybdenum steel jaws
- Push lever for quick unclamping



Model	Size
<b>T28263</b>	10" 250mm

## Locking Pliers (V-Curved Jaws)

- Chrome Molybdenum steel jaws
- Push lever for quick unclamping



Model	Size
<b>T28260</b>	10" 250mm

## Locking C-Clamp w/ Swivel Pads

- Chrome Vanadium steel jaws
- Push lever for quick unclamping



Model	Size
<b>T28265</b>	6" 150mm
<b>T28266</b>	11" 280mm
<b>T28267</b>	18" 455mm

## Locking C-Clamp

- Chrome Vanadium steel jaws
- Push lever for quick unclamping



Model	Size
<b>T28268</b>	6" 150mm
<b>T28269</b>	11" 280mm
<b>T28270</b>	18" 455mm





### Sheet Metal Grip

- Chrome Vanadium steel jaws
- Push lever for quick unclamping



Model	Size
<b>T28273</b>	10" 250mm

### Locking Chain Pliers

- Holds and locks around any size or shape with an 18 inch chain



Model	Size
<b>T28274</b>	18" 450mm

### Welder's Grip Wrench

- Chrome Molybdenum steel jaws
- Push lever for quick unclamping



Model	Size
<b>T28271</b>	9" 230mm

### Straight Jaw Plate-Grip Pliers

- Great for plate work applications including automobile, machinery, etc.



Model	Size
<b>T28230</b>	7-1/2" 195mm

### Wide Curved Jaw Plate-Grip Pliers

- Great for plate work applications including automobile, machinery, etc.



Model	Size
<b>T28231</b>	8-1/2" 215mm

### J-Type Plate-Grip Pliers

- Great for plate work applications including automobile, machinery, etc.



Model	Size
<b>T28232</b>	8" 200mm

### Double J Plate-Grip Pliers

- Great for plate work applications including automobile, machinery, etc.



Model	Size
<b>T28233</b>	9" 230mm

### Wide Flat Jaw Plate-Grip Pliers

- Great for plate work applications including automobile, machinery, etc.



Model	Size
<b>T28234</b>	8" 200mm



# Professional Hammers

Strength and Power





## Ball Pein Hammer - Wood Handle

- Genuine hickory



Model	Weight
<b>T20600</b>	8oz. 225g
<b>T20601</b>	12oz. 340g
<b>T20602</b>	16oz. 450g
<b>T20604</b>	24oz. 680g
<b>T20605</b>	32oz. 900g

## Claw Hammer - Wood Handle

- Genuine hickory



Model	Weight
<b>T20610</b>	8oz. 225g
<b>T20611</b>	12oz. 340g
<b>T20612</b>	16oz. 450g
<b>T20613</b>	20oz. 560g
<b>T20614</b>	24oz. 680g

## Engineer's Hammer - Wood Handle

- Genuine hickory



Model	Weight
<b>T20660</b>	10oz. 300g
<b>T20662</b>	17oz. 500g
<b>T20661</b>	20oz. 600g

## Cross Pein Hammer - Wood Handle

- Genuine hickory



Model	Weight
<b>T20570</b>	4oz. 110g
<b>T20571</b>	8oz. 220g

## Club Hammer - Wood Handle (British Style)

- Genuine hickory



Model	Weight
<b>T20657</b>	40oz. 1100g
<b>T20658</b>	64oz. 1800g

## Stone Hammer - Wood Handle (German Style)

- Genuine hickory



Model	Weight
<b>T20655</b>	35oz. 1000g
<b>T20656</b>	44oz. 1250g



### Roofing Hammer - Wood Handle

- Genuine hickory



**Magnetic Nail Slot for One-Handed Nailing**



Model	Weight
<b>T20688</b>	21oz. 600g

### Brick Hammer - Wood Handle

- Genuine hickory



Model	Weight
<b>T20693</b>	20oz. 560g

### Single-Ended Scutch Hammer - Wood Handle

- Genuine hickory



Model	Weight
<b>T20576</b>	20oz. 560g

### Double-Ended Scutch Hammer - Wood Handle

- Genuine hickory



Model	Weight
<b>T20577</b>	22oz. 620g

### French Joiner Hammer - Wood Handle

- Genuine hickory



Model	Size
<b>T20672</b>	30mm
<b>T20673</b>	32mm
<b>T20674</b>	35mm
<b>T20675</b>	40mm
<b>T20676</b>	42mm
<b>T20677</b>	45mm

### Mason's Hammer - Wood Handle

- Genuine hickory



Model	Weight
<b>T20694</b>	21oz. 600g



### Ball Pein Hammer - All-Steel Handle

- One piece steel with cushioned handle



Model	Weight
<b>T20627</b>	16oz. 450g
<b>T20628</b>	20oz. 560g

### Brick Hammer - All-Steel Handle

- One piece steel with cushioned handle



Model	Weight
<b>T20698</b>	21oz. 600g

### Claw Hammer - All-Steel Handle

- One piece steel with cushioned handle



Model	Weight
<b>T20637</b>	16oz. 450g
<b>T20638</b>	20oz. 560g

### Club Hammer - All-Steel Handle

- One piece steel with cushioned handle



Model	Weight
<b>T20648</b>	40oz. 1100g
<b>T20649</b>	64oz. 1800g

### Mason's Hammer - All-Steel Handle

- One piece steel with cushioned handle



Model	Weight
<b>T20697</b>	21oz. 600g

### Roofing Hammer - All-Steel Handle

- One piece steel with cushioned handle



**Magnetic Nail Slot for One-Handed Nailing**

Model	Weight
<b>T20696</b>	21oz. 600g



### Carpenter's Hammer - Tubular Steel Handle

- 1.4mm Hardened tubular steel handle
- Black baked paint finish with magnetic nail holder
- Hammer head with half through roll-pin



Model	Weight
<b>T20690</b>	20oz. 560g

### Roofing Hammer - Tubular Steel Handle

- 1.4mm Hardened tubular steel handle
- Black baked paint finish
- Hammer head with half through roll-pin



Model	Weight
<b>T20691</b>	21oz. 600g

### Ball Pein Hammer - Fiberglass Handle

- Fiberglass handle
- Deluxe rubber grip with P.P. cover
- Fully polished, round face & octagonal neck



Model	Weight
<b>T20621</b>	12oz. 340g
<b>T20622</b>	16oz. 450g
<b>T20624</b>	24oz. 680g
<b>T20625</b>	32oz. 900g

### Claw Hammer - Fiberglass Handle

- Fiberglass handle
- Deluxe rubber grip with P.P. cover
- Fully polished, round face & octagonal neck



Model	Weight
<b>T20631</b>	7oz. 198g
<b>T20632</b>	16oz. 450g
<b>T20634</b>	24oz. 680g

### Stubby Claw Hammer - Grip Handle

- Stubby size tool to work in confined areas
- Comfortable two-tone grip handle



Model	Weight
<b>T20630</b>	8oz. 225g

### T20670 Safety Exit Hammer

- Metal tip that shatters even heavy duty automobile window glass to open an escape outlet
- Recessed (to prevent accidental injury) razor blade slices right through the toughest seat belts

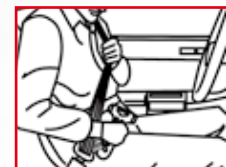

Cuts seat belt



Breaks window



## T20681 7pc Hammer and Dolly Set

- Contents:
  - 1 - Curved Dolly
  - 1 - Utility Dolly
  - 1 - Double End Hand Dolly
  - 1 - Shrinking Dolly
  - 1 - Standard Bumping Hammer Pick
  - 1 - Finish Hammer
  - 1 - Reverse Curve Hammer



## Sledge Hammer - Wood Handle

- Genuine hickory

Model	Weight
<b>T20580</b>	64oz. 1800g
<b>T20582</b>	128oz. 3600g
<b>T20584</b>	160oz. 4500g
<b>T20586</b>	224oz. 6200g



## Sledge Hammer - Fiberglass Handle

Model	Weight
<b>T20590</b>	64oz. 1800g
<b>T20592</b>	128oz. 3600g
<b>T20594</b>	160oz. 4500g
<b>T20596</b>	224oz. 6200g



## Axe - Fiberglass Handle

Model	Weight
<b>T11183</b>	21oz. 600g
<b>T11185</b>	28oz. 800g
<b>T11188</b>	44oz. 1250g



## Dead Blow Hammers

- Soft face, shockless urethane hammers
- Cushioned grip
- No rebound on most surfaces



(A)



(B)

	Model	Weight
(A)	<b>T74531</b>	24oz. 700g
(A)	<b>T74533</b>	35oz. 1000g

	Model	Weight
(B)	<b>T74536</b>	24oz. 680g
(B)	<b>T74537</b>	36oz. 1020g

## 2-in-1 Soft Face Hammer - Tubular Steel Handle

- Soft face hammer for where no surface marking is desired
- Tubular steel handle
- Cushioned grip

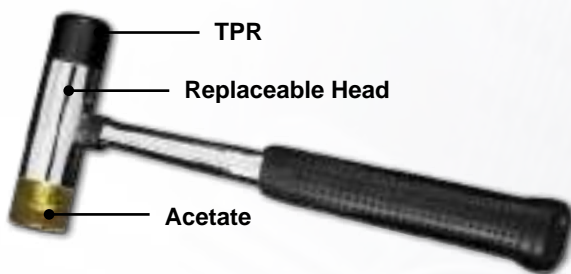

Model	Weight
<b>T20654</b>	16oz. 450g

## Rubber Mallet - Wood Handle

- Genuine hickory
- Great for striking blows where steel hammers would damage work surface



Model	Weight
<b>T20650</b>	16oz. 450g

## 2-in-1 Quick Change Hammer - Fiberglass Handle

- Shock absorbing fiberglass handle reduces vibration on impact and has a non-slip rubber grip for comfort and durability
- Plastic heads won't mark or spark, preventing surface damage and protecting both the product and user
- Convex striking surface minimizes bounce
- Includes medium plastic head and a high grade carbon steel head that can be used for normal hammer applications
- Overall dimensions: 1-9/16" (W) x 12" (L) x 3-15/16" (H)
- Weight: 20oz. (570g)

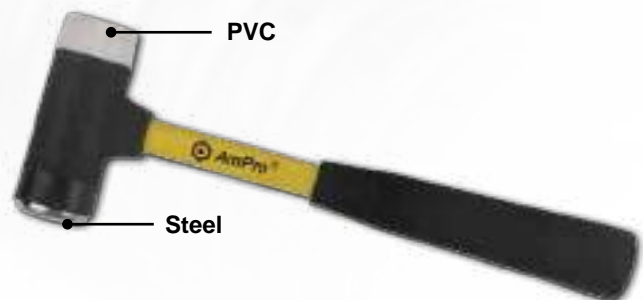

Model	Weight
<b>T20653</b>	20oz. 570g

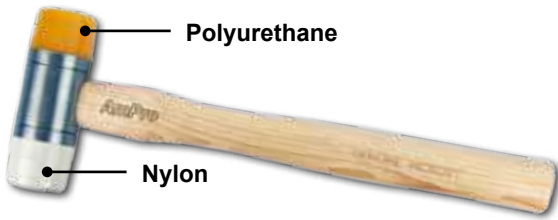

### Soft Face Hammer - Wood Handle

- Genuine hickory
- Soft faces are replaceable
- Durable plastic to protect work surfaces

Model	Face Diameter
<b>T20641</b>	35mm
<b>T20642</b>	40mm
<b>T20643</b>	45mm

### **T20667** Beechwood Mallet

- Features solid head and angled striking faces
- Tapered morticed shaft







# Tackers / Staplers





### T35101 Staple Gun Tacker 4 - 8mm

- Uses fine wire staples 4 - 8mm
- Suitable for stapling thin materials to wood
- Ideal for a wide range of applications
- Can drive staples into some of the toughest surfaces



### T35102 Staple Gun Tacker 6 - 14mm

- Delivers high power and deep penetration
- Interior cushioned grip for added comfort
- Easy-slide full stick staple load
- Includes 400pcs of 8mm replacement staples
- Compatible with 6 - 14mm staple sizes



### T35103 Staple Gun Tacker 4-14mm

- Adjustment screw controls impact tension
- Ideal for all kinds of fabrics / textile or thin wooden profiles
- Uses fine wire staples 4 - 14mm
- Recoilless for comfortable operation



### T35105 4-in-1 Staple Gun Tacker

- Uses flat wire staples 6 - 14mm, 7.6mm cable staples 10 - 14mm, brad nails 10 - 14mm and pin 14mm
- Heavy duty for multi-purpose use
- Quick jam release button
- Impact power adjustment



### T35106 4-in-1 Staple Gun Tacker

- Uses fine wire staples 4 - 14mm, 6.2mm cable staples 10 - 14mm, brad nails 10 - 14mm and pin 14mm
- Heavy duty for multi-purpose use
- Quick jam release button
- Impact power adjustment

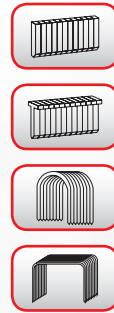

### T35108 Professional Staple and Nail Gun

- Uses flat wire staples 6 - 16mm and brad nail 16mm
- Patented safety locking mechanism for protection and ease of use
- Max-Normal (-, +) power impact control, maximum setting for long staples or hard materials
- Recoilless for comfortable operation

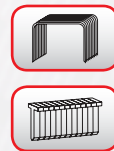

### T35110 Professional Cable Tacker

- Uses cable staples 10 - 14mm
- Patented safety locking mechanism for protection and ease of use
- Max-Normal (-, +) power impact control, maximum setting for long staples or hard materials
- Recoilless for comfortable operation
- Wired guide control to drive



### T35115 Hand Plier Stapler

- Load two sizes of fine staples 24 / 6 - 8mm, 26 / 6 - 8mm
- Light duty



### T35116 Heavy Duty Plier Stapler

- Three different type of anvils
- Load flat wire staples 6 - 12mm
- Excellent for sealing light weight containers, sacks, bags, etc.







### T35118 Hammer Tacker

- Uses flat wire staples 6 - 10mm
- Easy loading
- Ergonomic rubber grip
- Four-way grip
- Easy jam clearing
- Precision locked rear loading



### T35121 Heavy Duty Staple Remover

- Ergonomic design
- High leverage for ease of use



### Nails



### Pin Staples



16

Model	Size
T35155	10mm, 1000pc
T35156	12mm, 1000pc
T35157	14mm, 1000pc

Model	Size
T35166	14mm, 1000pc

### Staples



### Cable Staples



Model	Size
T35140	Wire 0.7mm, 6mm, 1000pc
T35141	Wire 0.7mm, 8mm, 1000pc
T35142	Wire 0.7mm, 10mm, 1000pc
T35143	Wire 0.7mm, 12mm, 1000pc
T35144	Wire 0.7mm, 14mm, 1000pc
T35146	Wire 1.2mm, 6mm, 1000pc
T35147	Wire 1.2mm, 8mm, 1000pc
T35148	Wire 1.2mm, 10mm, 1000pc
T35149	Wire 1.2mm, 12mm, 1000pc
T35150	Wire 1.2mm, 14mm, 1000pc

Model	Size
T35160	Wire 1.2mm, Crown 7.6mm, 10mm, 1000pc
T35161	Wire 1.2mm, Crown 7.6mm, 12mm, 1000pc
T35162	Wire 1.2mm, Crown 7.6mm, 14mm, 1000pc
T35163	Wire 1.2mm, Crown 6.2mm, 10mm, 1000pc
T35164	Wire 1.2mm, Crown 6.2mm, 12mm, 1000pc



# Knives, Cutters & Scrapers







T23216

T23217

T23218

### Snap-Off Knives

- SK4 Steel blades
- Stores up to 3 replacement blades
- Blade sections snap off providing sharp cutting point
- Stainless steel housing
- Auto blade lock
- Ergonomic handle for maximum control and comfort

**T23216 Snap-Off Knife w/ 3 (9mm) Blades**

**T23217 Snap-Off Knife w/ 3 (18mm) Blades**

**T23218 Snap-Off Knife w/ 5 (25mm) Blades**



**T23215 Mini Auto Lock Snap-Off Knife w/ 3 Blades**

- Blade sections snap off providing sharp cutting point
- Stainless steel housing
- SK4 steel blades
- Auto blade lock
- Stores up to 3 replacement blades



### Auto Lock Snap-Off Knives

- Heavy duty zinc alloy housing
- SK4 steel blades
- Ergonomic cushioned grip
- Rubber enclosed case for improved resistance

Model	Blade Size
T23205	9mm
T23206	18mm



T23219

T23220

T23221

**T23219 10pc 9mm Snap-Off Replacement Blades**

- Size: 80 x 9 x 0.4mm

**T23220 10pc 18mm Snap-Off Replacement Blades**

- Size: 100 x 18 x 0.5mm

**T23221 10pc 25mm Snap-Off Replacement Blades**

- Size: 100 x 25 x 0.5mm



**T23360 14pc Hobby Knife Set**

- Contents:
  - 1- Two-colored cushion grip balde handle w/blade
  - 1 - Rubber coated blades holder w/blade
  - 12 - Woodcarving blades (SK5)



### T23212 Retractable Utility Knife

- Push-button for quick blade change
- Swing-out blade storage in handle
- Ergonomic cushioned grip
- Includes 6 replacement blades



### T23207 Quick Slide Utility Knife

- Retractable design for one-hand operation and compact storage
- Standard blades allow easy replacement
- Quick-release button for simple blade change
- Convenient belt clip for handy usage



### T73777 Retractable Utility Knife

- Heavy duty construction
- Retractable blades for safe storage
- Four adjustable cutting positions
- Extra blade included



### T23225 Snap-Off & Utility Knife Set

- Contents:
  - 1 - Retractable Utility Knife (T23212)
  - 1 - 9mm Snap-Off Knife (T23216)
  - 1 - 18mm Snap-Off Knife (T23217)
  - 5 - Utility Knife Blades
  - 5 - 100 x 9 x 0.5mm Snap-Off Blades
  - 5 - 100 x 18 x 0.5mm Snap-Off Blades



### T23203 Heavy Duty Quick Change Retractable Utility Knife

- Heavy duty die cast aluminum handle
- Quick-release/lock feature allows easy blade replacement
- Inner handle stores up to 12 spare blades (not included)
- 3-Position retractable blade for safety
- Convenient carry holster



### T23202 "Safety" Utility Knife

- Spring action blade retraction assures cutting only when fully gripped
- Heavy duty all metal housing with extra large thumb lever
- Perfect for quick cuts on taped cartons or plastic sheets



### T23204 50pc Universal Knife Blade Set

- Plastic safety holder dispenses individual blades
- Contains 50pc, double notched alloy steel blades

### T23224 5pc Hook Blade Set (SK5)

- SK5 Steel blades
- Size: 50 x 20 x 0.6mm

### T73778 5pc Utility Knife Replacement Blades

- High quality steel blades





### T23341 "Dolphin" Folding Utility Knife

- Comfortable dolphin shape handle
- Foldable design for one-hand operation and compact storage
- Quick-release button for simple blade change
- Standard retractable blades allow easy replacement
- Includes 5 replacement blades



### T23335 "Dolphin" 2-in-1 Folding Utility Knife

- Comfortable dolphin shape handle
- Foldable design for one-hand operation and compact storage
- Quick-release button for simple blade change
- Standard retractable blades allow easy replacement
- Includes 5 replacement blades



### T23208 Quick-Release Utility Knife

- Foldable design for one-hand operation and compact storage
- Standard retractable blades allow easy replacement
- Quick-lock mechanism for precise and safe cutting
- Convenient belt clip for handy usage
- Includes 5 replacement blades



### T23286 2-in-1 Folding Utility Knife

- Foldable design for one-hand operation and compact storage
- Standard retractable blades allow easy replacement
- Liner-lock utility & drop point knives
- Thumb knob for one handed opening
- Includes belt clip



17

### T23280 4-3/4" Liner-lock Folding Knife

- 4-3/4" Liner-lock knife with 2" stainless steel blade
- Synthetic pearl shell handle
- Pocket-sized for easy carrying



### T23281 7-1/4" Liner-Lock Folding Knife

- 3" Stainless steel blade
- Thumb knob for one handed opening
- Composition stainless steel & pearl shell handle



### T23315 2pc Liner-lock Folding Knife Set

- Stainless steel blades



### T23282 7" Lockback Folding Knife

- Heavy duty cutting blade
- Stainless steel blade
- Folds in half for compact storage
- Safety lock





### T23283 8-1/2" Liner-lock Folding Knife

- Heavy duty cutting blade
- High quality stainless steel
- Folds in half for compact storage
- Safety lock



### T23292 7-1/4" Liner-Lock Folding Knife

- 7-1/4" Liner-lock knife with 3-1/4" stainless steel blade with partial serration
- Thumb knob for one handed opening
- Aluminum handle w/ black finish
- Drilled to accept lanyard
- Includes belt clip



### T23284 8-1/4" Lockback Folding Knife

- 3-1/2" Stainless steel blade
- Drilled to accept lanyard



### T23293 7-3/4" Liner-Lock Foldable Knife (Red)

### T23294 7-3/4" Liner-Lock Foldable Knife (Blue)

- 7-3/4" Liner-lock knife with 3-1/4" stainless steel blade
- Foldable design for one-hand operation and compact storage



T23294

T23293

### T23298 3-in-1 Camo Folding Knife

- 3 Convenient functions including 3-1/2" stainless steel blade
- 3-1/2" blade with partial serration
- Non-slip handle for firm grip



### All-Around Knife & Chisel Knife

- Stainless steel blade
- Soft, ergonomic handle reduces fatigue
- Hang hole for convenient storage

### T23245 All-Around Knife



### T23246 Chisel Knife

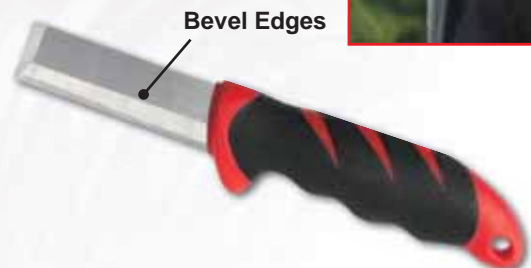



### T23290 6-in-1 Multi-Function Tool

- Pocket-sized tool packed with 6 convenient functions
- Pakkawood handle



### T23285 8-in-1 Multi-Function Tool

- 8 Convenient functions including springless lever action scissors and saw
- 3" (75mm) blade with partial serration
- High quality stainless steel blade & body



### T23287 8-in-1 Multi-Function Tool

- High quality stainless steel blade & body
- Durable, compact construction
- Ideal tool for outdoor use



### T23288 13-in-1 Multi-Function Tool

- High quality stainless steel blade & body
- Durable, compact construction
- Ideal tool for outdoor use



### T23289 15-in-1 Multi-Function Tool

- High quality stainless steel blade & body
- Durable, compact construction
- Ideal tool for outdoor use



### Insulated Cable Knife

- Composite handle cable knife with straight blade and protective cover
- Anti-slip guard for complete protection
- Fully insulated to VDE standards to protect from electric shock up to 1000V

Model	Blade Length	Length
<b>T23240</b>	2" 50mm (Straight Blade)	8" 200mm
<b>T23241</b>	2" 50mm (Curved Blade)	8" 200mm





### 3-in-1 Bolt Cutters

- Multi-function for cutting bolts, wires and cables
- Heavy duty construction for performance and durability

	Model	Size
<b>A</b>	<b>T28630</b>	9" 230mm
	<b>T28631</b>	14" 355mm
<b>B</b>	<b>T28632</b>	18" 450mm
	<b>T28633</b>	24" 610mm
	<b>T28634</b>	36" 910mm



### 3-in-1 Bolt Cutters (Angled Blade)

- Great for angle-cutting bolts in concrete walls or elsewhere
- Chrome Vanadium steel blades
- Heat-treated, high tensile jaws
- Cushioned grip

	Model	Size
	<b>T28637</b>	18" 450mm
	<b>T28638</b>	24" 610mm
	<b>T28639</b>	36" 910mm

### T30918 Heavy Duty Cable Cutter (Soft Wire)

- Chrome Vanadium steel
- Compound leverage increases cutting power while reducing cutting effort
- Cuts copper and aluminum electric cables up to size number 2AWG (14mm) / 5/16" (8mm) diameter



### T30919 Cable Cutter

- High-leverage design for greater cutting power
- Chrome Vanadium steel blades for clean cut
- Compact size fits most tool pouches
- Comfort grip for non-slip handling
- Capacity: 4.0mm Aluminum, 2.0mm soft copper



### T30940 Multi-Purpose Electric Scissors

- High carbon stainless steel with Molybdenum and Vanadium blades
- Micro-serration blade reduces slippage
- Extension tang adds leverage
- Cuts soft cable up to 22mm in diameter, insulation materials, electrical tape, cable tie and many other materials
- Overall length: 5-1/2" (138mm)  
Cutting length: 1-5/8" (42mm)



### Straight Pattern Snips

- Straight pattern tin snips with serrated cutting edges to prevent slippage when cutting
- Forged alloy steel construction
- Double pivot action and scissor pattern
- Enclosed handles with soft touch comfort finish

Model	Size
<b>T30915</b>	10" 250mm
<b>T30916</b>	12" 305mm





## Aviation Tin Snips



- Chrome Molybdenum steel blade
- Quick and simple spring-free automatic lock design for safety
- Two-tone color, cushioned handle
- Cuts up to 1.2mm cold rolled steel

Model	Size
<b>T73321</b>	"Straight Cut" Aviation Tin Snips
<b>T73322</b>	"Left Cut" Aviation Tin Snips
<b>T73323</b>	"Right Cut" Aviation Tin Snips

## T30923 Multi-Purpose Angled Shear

- Constructed of tough SUS 420J2 stainless steel
- Serrated blade for anti-slippage
- Spring-loaded reduces fatigue
- Extension tang adds leverage
- Cuts wood sticks, dowel rods, cardboard, ropes, cords, soft metal wires up to 2.5mm in diameter
- Overall length: 8" (205mm)
- Cutting length: 2" (50mm)



## T30920 Multi-Purpose Work-Shop Shear Cutter

- Heat-treated, stainless steel blades, bolt nut and washer
- Lightweight, spring action for better control
- Security lock for added safety
- Overall length: 7-1/2" (190mm)
- Cutting length: 1-5/8" (42mm)



## T30921 Light-Duty Cable Cutter

- Heat-treated stainless steel blades, bolt nut and washer
- Lightweight, spring action for better control and fatigue reduction
- Security lock for added safety
- Overall length: 6-1/2" (165mm),
- Cutting capacity: up to 3/8" (10mm) soft cable



## T15918 PVC Pipe Cutter

- Heat-treated cutting blade cuts PVC pipe and water hose up to 42mm diameter, cable duct & other flat plastic materials
- High quality SK5 alloy steel blade
- Cleanly cuts without the need for de-burring



## T15925 Soft Pipe Tubing Cutter

- Cuts soft vinyl tubing and hose
- PVC Handle
- Cuts from 1/2" to 1-1/2"







### T15919 PVC Cutter w/ Adaptor

- Heat-treated cutting blade cuts PVC pipe and water hose up to 45mm diameter, cable duct & other flat plastic materials
- High quality SK5 alloy steel blade
- Cleanly cuts without the need for de-burring



### T15924 Large Heavy Duty PVC Pipe Cutter

- Ratcheting action for quick cuts
- Virtually perfect right angle cuts
- Hardened steel blade
- Cuts from 1/2" to 2-1/2" PVC



### T25606 6-in-1 Multi-Purpose Scraper

- 6-in-1 Uses: wall scraper, paint roller cleaner, paint remover, nail & tack remover, putty & grout remover and putty knife
- Ergonomic TPR handle for maximum comfort and grip
- Hardened stainless steel blade for strength and durability
- Ribbed, cushioned handle for secure grip



### T25600 1-1/4" Go-Thru Scraper - Straight

- Ergonomic TPR handle for maximum comfort and grip
- Hardened stainless steel blade for strength and durability



### T25602 3" Go-Thru Scraper - Angled

- Ergonomic TPR handle for maximum comfort and grip
- Hardened stainless steel blade for strength and durability



### T25601 1-1/4" Go-Thru Scraper - Angled

- Ergonomic TPR handle for maximum comfort and grip
- Hardened stainless steel blade for strength and durability



### T25604 3pc Go-Thru Scraper Set

- Contents:
  - 1 - 1-1/4" Go-Thru Scraper - Straight
  - 1 - 1-1/4" Go-Thru Scraper - Angled
  - 1 - 3" Go-Thru Scraper - Angled



### Stainless Steel Flex Scraper

- Cushioned grip handle
- Semi-flexible tempered blades
- Hang hole for convenient storage

Model	Size	Model	Size
T25650	3-1/8" 80mm	T25655	7" 180mm
T25651	4" 100mm	T25656	8" 200mm
T25652	4-3/4" 120mm	T25657	8-1/3" 220mm
T25653	5-1/2" 140mm	T25658	9-1/2" 240mm
T25654	6" 160mm		



### T25666 4-in-1 Extendable Scraper

- 5" (125mm) to 9-1/2" (240mm) in length
- Uses single edge blades
- TPR soft grip handle
- Blade storage in handle

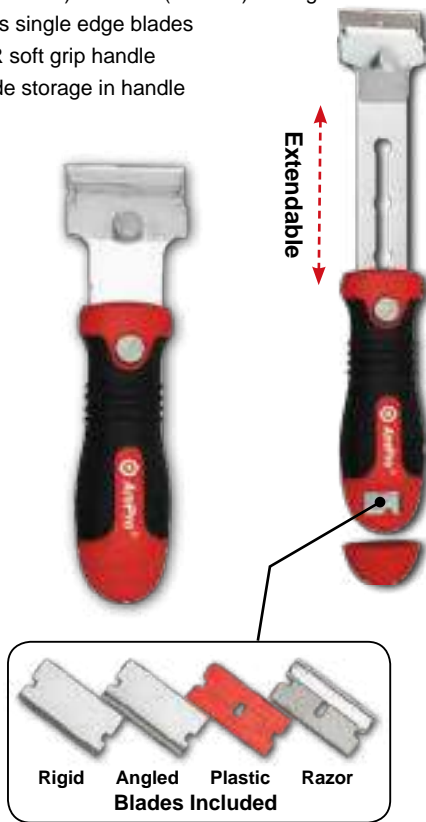

### T25667 4-in-1 Scraper

- 8-1/2" (215mm) in length
- Uses single edge blades
- TPR soft grip handle
- Blade storage in handle



### T25665 Stubby Scraper

- 4.5" (110mm) in length
- Uses single edge blades
- TPR Soft grip handle
- Great for confined spaces



### T25668 2pc Scraper Set

- Stubby scraper 4-1/2" (115mm) in length
- Standard scraper 8-1/2" (215mm) in length
- Uses single edge blades
- TPR soft grip handle
- Blade storage in handle

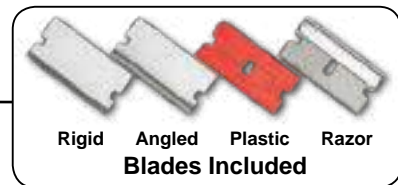

### T19561







# Magnetic Sweepers Pickup Tools







### T24700 Power Magnetic Pickup Tool

- Pick up ferrous metal items such as tools, bolts, paper clips, nails, etc.
- Pull trigger to release magnetic force
- Easy-to-use
- Safe, practical and time saving
- Permanent magnet



### T24710 Power Clean Up Magnet

- Quickly and safely cleans up sharp cuts like iron & steel chips and waste
- Release small parts upon pulling the bar
- Easy to clean up work zone, factory, house or workshop
- Easy to pick up and release scrap and ferrous debris
- Permanent magnet
- Light, non-rusting shaft

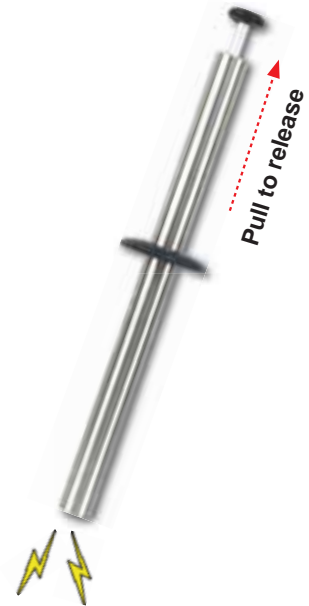

### T24702 Magnetic Finder

- Pick up ferrous metal items such as tools, bolts, paper clips, nails, etc.
- Telescopic handle extends from 26" (660mm) to 42-1/2" (1080mm)
- Ergonomic handle for comfort
- Easy-to-use
- Safe, practical and time saving
- Permanent magnet



### T24701 Power Magnetic Pickup Tool

- Pick up ferrous metal items such as tools, bolts, paper clips, nails, etc.
- Pull trigger to release magnetic force
- Easy-to-use
- Safe, practical and time saving
- Permanent magnet



## T24711 Mini Power Magnetic Pickup Tool

- Easily picks up various kinds of hand tools and small iron or steel parts
- Pull trigger to release magnetic force
- Permanent magnet
- Light and handy design
- Impact-proof plastic



## T24706 Magnetic Rake with Release Function

- Perfect for picking up metal items from sand, grass and wool chips
- Turn knob to release magnetic force
- Telescoping handle from 26-1/2" (675mm) to 39-3/4" (1100mm)



## T24707 Release Magnetic Finder with Wheels

- Powerful magnet easily picks up metal items and spare parts
- Pull trigger to release magnetic force
- Easy-to-use
- Safe and practical time saving device
- Permanent magnet





### Adjustable Telescopic Mirror w/ Pocket Handle

- Convenient pen type pocket clip
- Extends from 4-3/4" (120mm) to 19-1/2" (495mm)
- Chrome finish
- Special joint design allows mirror to move at any angle



Model

<b>T73500</b>	1-1/4" round mirror
<b>T73502</b>	2" round mirror
<b>T73503</b>	1" x 2" oval mirror

### T73584 Flexible Inspection Mirror w/ Light

- Heavy duty construction
- Flexible shaft
- 1" x 2" Oval mirror
- Uses 2AA Batteries (not included)



### T73552 Telescoping Rectangular Mirror

- 2" x 3-1/2" Rectangular mirror
- Extends from 8-1/4" (210mm) to 19-1/2" (495mm)
- Mirror angles to any direction



### T73504 3-in-1 Telescopic & Lighted Pickup Tool

- 3 Interchangeable pickup tools excellent for retrieving lost parts, tools, nuts and bolts
- 3lbs lighted magnetic pickup and 5lbs magnetic pickup adaptors stored in handle
- Lighted magnet illuminates and retrieves small parts in dark, confined area



Swivel Inspection Mirror



Magnetic pickup retrieves up to 5 lbs



Lighted magnetic pickup retrieves up to 3 lbs





### T73505 Magnetic Pickup with LED Light

- Extends from 7-1/2" (190mm) to 27" (690mm)
- Lifts up to 4-1/2 lbs



### T73489 24" (610mm) Flex Retriever Claws

- 24" (610mm) Flexible shaft to reach confined areas
- Strong spring claws expand to 1" (25mm)



### T73616 Pocket Magnetic Pickup

- Pen-type pocket clip design
- Extends from 5" (125mm) to 25" (635mm)
- Powerful magnet
- Lifts up to 0.8 lbs



### T73619 Magnetic Pickup (3-1/2 lbs)

- Pen-type pocket clip design
- Extends from 5" (125mm) to 25-1/2" (647mm)
- Lifts up to 3-1/2 lbs



### T73620 Heavy Duty Magnetic Pickup (8 lbs)

- Extends from 6-3/4" (170mm) to 24" (610mm)
- Lifts up to 8 lbs



### T73621 Heavy Duty Magnetic Pickup (16 lbs)

- Extends from 7-1/2" (190mm) to 30" (706mm)
- Lifts up to 16 lbs





### T73655 Telescoping Magnetic Pickup

- Double ball joints allow magnetic head to swivel 360°
- Vinyl handle for secure grip
- Heavy duty construction
- Strong magnet capable of lifting up to 2-1/2 lbs
- Telescopes from 13" (330mm) to 27" (685mm)



### T73617 Heavy Duty Flexible Magnetic Pickup

- Flexible shaft reaches confined areas
- Lifts up to 3-1/2 lbs



### T73585 Flexible Flashlight with Magnetic Pickup

- Flexible shaft reaches confined areas
- Magnetic tip
- Uses 2 AA batteries (not included)



### T73583 Flexible Inspection Mirror with Light

- 1" x 2" Oval mirror
- Flexible shaft holds any shape
- Magnetic tip
- Uses 2 AA batteries (not included)



### T73685 Telescoping Magnet with LED Light

- Pen-type pocket clip design
- Extends from 6-1/2" (165mm) to 14" (355mm)
- Includes 2 batteries



## T73491 3-in-1 Retriever Claw & Lighted Magnetic Pickup Tool

- Flexible shaft enables access to confined areas
- Adjustable claw length, light pickup tool
- Retrieves objects easily with the handle
- Includes 3 button cell batteries (1.5V)



## T73580 8pc Multi-Function Inspection Tool Set

- Hinged pieces swivel for accurate and easy positioning
- Convenient on / off push button
- All pieces are interchangeable and can be used together or separately
- Zippered pouch w/ protective foam for convenience and organization
- Contents:
  - 1 - Aluminum Interchangeable Handle
  - 1 - Inspection Mirror
  - 1 - 6 lbs Magnetic Retriever
  - 1 - 10" Flexible Extension
  - 1 - 9" 135-Degree Bended Extension
  - 1 - 8" Straight Extension
  - 1 - UV Light
  - 1 - LED Light

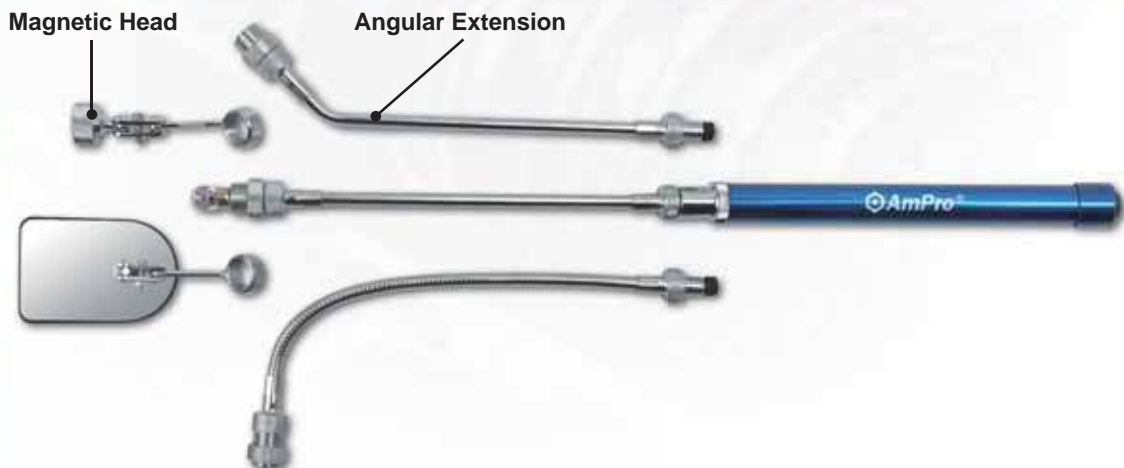





### T70736 4pc Pick Set

- Complete scribe and hook set for pin pulling, picking O-rings, etc.
- Durable, heat-treated steel
- Curved hook, Offset 45-degree hook, 90-degree hook, Straight pick



### T70714 2pc O-Ring Hook and Scribe Set

- Both tools facilitate easy removal and installation of O-rings and seals
- Can also be used to retrieve small items
- Knurled handle for sure grip



### T70737 8pc Mini Pick and Driver Set

- Removes and replaces seals, O-rings, nuts, clips, springs, pins, washers, etc.
- Chrome Vanadium steel
- Contents:
 

1 - Curved Hook	1 - Offset 45° Hook
1 - 90° Hook	1 - Straight Pick
4 - Screwdrivers:	
1 - Slotted: 1/8",	
1 - Phillips: #0	
2 - Star: T15, T20	

### T73785 Single Suction Cup

- Lifts, adjusts and positions windshield glass, sheet metal, sheet plastic and glazed items
- One-hand operation pulls out panel dents easily



### T73791 Heavy-Duty Double Suction Lifter Set

- Lifts, adjusts and positions windshield glass, sheet metal, plastic and glazed items
- Heavy duty construction with swivel heads
- Great for curved car windshields





# Woodworking Tools Building Tools







### T27914 Multi-Rasp Plane w/ Adjustable Handle

- Die cast body with 3-position adjustable handle
- Fitted with a replaceable 10" (250mm) blade



### T27913 Multi-Rasp Plane

- Die cast body with plastic handle
- Fitted with a replaceable 10" (250mm) blade



### T27910 Multi-Rasp Plane

- Shaves, smooths, trims, shape and forms a variety of materials for regular or decorative work
- Zinc alloy body construction
- Fitted with a replaceable 10" (250mm) blade



### T27911 Multi-Rasp Block Plane

- One-handed tool ideal for end-grain work, sheetrocking and smoothing laminate
- Thumbscrew blade tension
- Die cast alloy body construction
- Fitted with a replaceable 5-1/2" (140mm) blade



### T27922 Spoke Shave

- Individual spoke shave fitted with round face with 2" (50mm) blade
- Solid metal construction with metal blade adjustment knobs



### Multi-Rasp Replacement Blades

- High carbon steel construction



#### Flat File Blade

Model	Size
<b>T27916</b>	5-1/2" 140mm
<b>T27918</b>	10" 250mm



#### Half-Round File Blade

Model	Size
<b>T27917</b>	5-1/2" 140mm
<b>T27919</b>	10" 250mm



### Wood Plane

- Excellent for very clean work on end grain & plastic laminates
- Fully adjustable depth cut, cutter alignment and mouth size
- Strong die cast construction
- Knurled nut changes thickness of shaving
- Adjustable lever changes shaving evenness

Model	Size
<b>T27921</b>	42mm x 175mm
<b>T27920</b>	50mm x 247mm



## Wood Rasp File

- Used by wood workers, cabinet makers & furniture craftsmen
- Feature uniform, individually formed teeth

### Flat Wood Rasp File



Model	Size
<b>T18430</b>	8" 200mm
<b>T18436</b>	10" 250mm

### Half-Round Wood Rasp File



Model	Size
<b>T18432</b>	8" 200mm
<b>T18438</b>	10" 250mm

### Round Wood Rasp File



Model	Size
<b>T18431</b>	8" 200mm
<b>T18437</b>	10" 250mm

### Three-Square Wood Rasp File



Model	Size
<b>T18433</b>	8" 200mm
<b>T18439</b>	10" 250mm

### **T18434** 3pc 8" (200mm) Rasp File Set

- Contents:  
1 - Half-Round, 1 - Flat, 1 - Round



### **T18435** 4pc 8" (200mm) Rasp File Set

- Contents:  
1 - Half-Round, 1 - Flat, 1 - Round, 1 - Three-Square





### Wood Chisels

- Chrome Vanadium steel



Model	Size
T29575	1/4" 6mm
T29576	3/8" 10mm
T29577	15/32" 12mm
T29578	5/8" 16mm
T29579	3/4" 19mm
T29580	25/32" 20mm
T29581	1" 25mm
T29582	1-1/4" 32mm

### T29585 3pc Wood Chisel Set

- Chrome Vanadium steel
- Contents: 6, 12, 20mm



### T29586 4pc Wood Chisel Set

- Chrome Vanadium steel
- Contents: 6, 12, 19, 25mm



### Wood Chisels (Wood Handle)

- Chrome Vanadium steel



Model	Size
T29591	1/4" 6mm
T29592	3/8" 10mm
T29593	15/32" 12mm
T29594	5/8" 16mm
T29595	3/4" 19mm
T29596	1" 25mm
T29597	1-1/4" 32mm



### T29600 4pc Wood Chisel Set (Wood Handle)

- Chrome Vanadium steel
- Contents: 6, 10, 16, 19mm

## Center Punches

- Pierces or makes starting drills in metal and other materials
- Chrome Vanadium steel
- Painted matte black

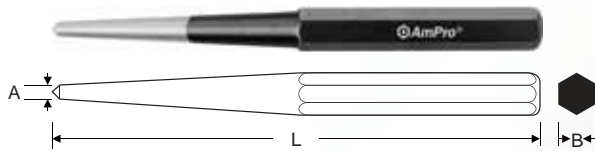

Model	(A)	(B)	(L)
<b>T29517</b>	4mm	10mm	120mm
<b>T29518</b>	5mm	10mm	120mm
<b>T29519</b>	5mm	12mm	150mm

## Cold Chisels

- Cuts, shapes and removes cold metals softer than the cutting edge of chisel and brickwork
- Chrome Vanadium steel
- Painted matte black

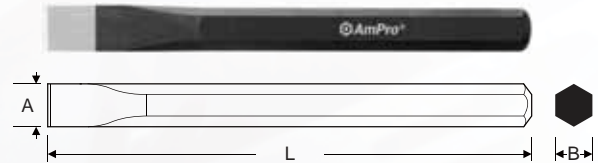

Model	(A)	(B)	(L)
<b>T29560</b>	23mm	16mm	200mm
<b>T29561</b>	23mm	16mm	250mm
<b>T29562</b>	26mm	18mm	300mm
<b>T29563</b>	26mm	18mm	350mm
<b>T29564</b>	30mm	20mm	400mm
<b>T29565</b>	30mm	20mm	500mm

## Pin Punches

- Drives out and removes already loosened pins and keys after initial movement by a solid punch
- Chrome Vanadium steel
- Painted matte black

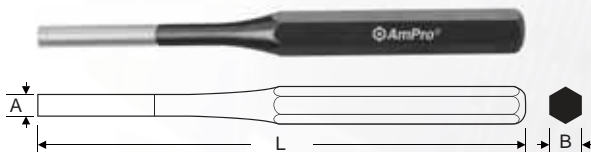

Model	(A)	(B)	(L)
<b>T29520</b>	2mm	10mm	150mm
<b>T29521</b>	3mm	10mm	150mm
<b>T29522</b>	4mm	10mm	150mm
<b>T29523</b>	5mm	10mm	180mm
<b>T29524</b>	6mm	10mm	150mm
<b>T29525</b>	6mm	10mm	180mm
<b>T29526</b>	8mm	12mm	150mm
<b>T29527</b>	8mm	12mm	190mm

## Taper Punches

- Loosens frozen or tight pins and keys or knocking out rivets
- Chrome Vanadium steel
- Painted matte black

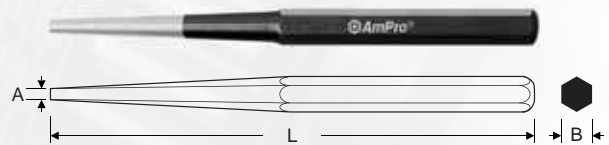

Model	(A)	(B)	(L)
<b>T29530</b>	2mm	10mm	120mm
<b>T29531</b>	3mm	10mm	120mm
<b>T29532</b>	4mm	10mm	120mm
<b>T29533</b>	5mm	10mm	120mm
<b>T29534</b>	6mm	10mm	120mm
<b>T29535</b>	7mm	12mm	120mm
<b>T29536</b>	8mm	12mm	120mm
<b>T29537</b>	9mm	12mm	150mm
<b>T29538</b>	10mm	12mm	150mm

## Flat Chisels

- Cuts, shapes and removes cold metals softer than the cutting edge of chisel and brickwork
- Chrome Vanadium steel
- Painted matte black

Model	(A)	(B) x (H)	(L)
<b>T29631</b>	15mm	14mm x 9mm	125mm
<b>T29632</b>	18mm	17mm x 11mm	150mm
<b>T29633</b>	21mm	20mm x 12mm	175mm
<b>T29634</b>	24mm	23mm x 13mm	200mm
<b>T29635</b>	25mm	23mm x 13mm	250mm







### T29654 11pc Punch & Chisel Set

- Chrome Vanadium steel
- Chrome plated to prevent rust
- Soft grip handle provides comfort and safety
- Contents:
  - 5 - Pin Punches: 2 x 140, 3 x 150, 4 x 180, 5 x 200, 6 x 210mm
  - 3 - Taper Punches: 4 x 185, 5 x 185, 6 x 185mm
  - 1 - Center Punches: 2.5 x 185mm
  - 2 - Cold Chisels: 12 x 160, 16 x 170mm



T29650



T29649

### T29650 6pc Punch & Chisel Set

- Chrome Vanadium steel
- Titanium coated finish
- Metal case for convenient storage
- Contents:
  - 2 - Cold Chisels: 11 x 10 x 130, 15 x 12 x 150mm
  - 1 - Cape Chisels: 4 x 10 x 130mm
  - 1 - Center Punches: 4 x 10 x 120mm
  - 2 - Taper Punches: 3 x 10 x 120, 4 x 12 x 150mm

### T29649 6pc Pin Punch Set

- Contents:
  - 3 - Pin Punches: 3 x 150mm, 5 x 150mm, 8 x 150mm
  - 3 - Taper Punches: 3 x 150mm, 5 x 150mm, 8 x 150mm

### T29644 6pc Long Pin Punch Set

- Sand blasted high carbon steel
- Contents:
  - 6 - Long Pin Punches:
    - 3 x 9.5 x 200mm, 4 x 9.5 x 200mm, 5 x 9.5 x 200mm
    - 6 x 11 x 200mm, 7 x 12 x 200mm, 8 x 12 x 200mm



### T29658 12pc Jumbo Punch & Chisel Set

- Sand blasted high carbon steel
- Contents:
  - 6 - Cold Chisels: 1/2" x 6-1/2", 5/8" x 7", 3/4" x 8", 7/8" x 8", 7/8" x 10", 1" x 10"
  - 2 - Center Punches: 5/32" x 6", 7/32" x 8"
  - 3 - Line-up Punches: 1/8" x 6", 7/32" x 10", 3/8" x 10"
  - 1 - Pin Punch: 3/8" x 8"



## T29661 4pc Nail Punch Set

- Hardened tempered carbon steel
- Fitted with square section striking head with a knurled body for extra grip
- Contents: 0.8, 1.5, 2.5, 3.0mm



## T29653 7pc Pin Punch Set

- Chrome Vanadium steel
- Hardened striking head for strength and durability
- Heavy duty pouch for storage
- Contents:
  - 2 x 150, 3 x 150, 4 x 150, 5 x 150, 6 x 150, 8 x 150, 10mm x 150mm



## T29643 9pc Pin Punch Set

- Chrome Vanadium steel
- Contents:
  - 1/16" x 4-1/4", 3/32" x 4-3/4", 1/8" x 5", 5/32" x 5-1/4"
  - 3/16" x 5-1/2", 7/32" x 7", 1/4" x 7", 5/16" x 7", 3/8" x 7"



## T29641 13pc Punch & Chisel Set

- Chrome Vanadium steel
- Contents:
  - 4 - Taper Punches:
    - 3/32" x 5-1/4", 1/8" x 5-3/4", 5/32" x 6", 3/16" x 6-1/4"
  - 4 - Cold Chisels:
    - 5/16" x 5", 3/8" x 5-1/2", 1/2" x 6", 5/8" x 6-1/2"
  - 4 - Pin Punches:
    - 3/32" x 4-1/4", 1/8" x 4-3/4", 5/32" x 5", 3/16" x 5-1/4"
  - 1 - Chisel Gauge



## T29640 16pc Punch & Chisel Set

- Chrome Vanadium steel
- Contents:
  - 5 - Taper Punches:
    - 3/32" x 5-1/4", 1/8" x 5-3/4", 5/32" x 6", 3/16" x 6-1/4", 1/4" x 6-3/4"
  - 3 - Cold Chisels: 3/8" x 5-1/2", 1/2" x 6", 5/8" x 6-1/2",
  - 5 - Pin Punches:
    - 3/32" x 4-1/4", 1/8" x 4-3/4", 5/32" x 5", 3/16" x 5-1/4", 1/4" x 5-3/4"
  - 2 - Center Punches: 1/8" x 5", 3/16" x 6"
  - 1 - Chisel Gauge





- Lever and cut through the tongues and grooves of floorboards
- High carbon steel with black oxide finish
- Ergonomic power soft rubber grip provides comfort and safety



T29611

T29612

T29626



Hand guard protects against misplaced hammer blows

### T29611 Brick Bolster w/ Hand Guard

- 100 x 22 x 225mm

### T29612 Cold Chisel w/ Hand Guard

- 25 x 19 x 300mm

### T29626 Pointed Chisel w/ Hand Guard

- 19 x 300mm

### T29655 3pc Cushioned Grip Punch & Chisel Set

- Shock-absorbing grip maximizes precision and power
- High carbon steel
- Chrome plated to prevent rust
- Contents:
  - 1 - 3/16" Pin Punch
  - 1 - Center Punch
  - 1 - 5/8" Chisel



Cushioned grip for added comfort and safety

Chrome plated to prevent rust

### T29659 6pc Brass Pin Punch Set

- Made of non-sparking solid yellow brass for safety around fuel lines
- Soft rubber grip provides comfort and safety
- Contents:
  - 1/16" (2mm), 1/8" (3mm), 5/32" (4mm), 3/16" (5mm)
  - 1/4" (6mm), 5/16" (8mm)



Cushioned grip for added comfort and safety

Brass pin punches are designed to prevent damage to object being struck



### T31001 Heavy Duty Hack Saw

- Tension adjusting knob keeps blade tight for the best cut
- Blade can be fixed at normal 90° or 45° angle for horizontal cuts
- Die cast handle with built-in hand guard
- Ribbed rubber grip for comfort
- Uses 12" (305mm) Bi-Metal blade



### T31002 Quick Change Professional Hack Saw

- Quick-release button allows for fast blade replacement
- Blade can be fixed at normal 90° or 45° angle for horizontal cuts
- Die cast handle with built-in tension keeps blade firm for best cut
- Rubber pad offers extra palm comfort and smooth cutting
- Uses 12" (305mm) Bi-Metal blade



### T31006 Heavy Duty Hack Saw

- Tension adjusting knob keeps blade tight for the best cut
- Blade can be fixed at normal 90° or 45° angle for horizontal cuts
- Ergonomic, die cast "bow frame" design
- Cushioned grip for extra comfort
- Uses 12" (305mm) blade



### T31015 12" 4-in-1 Multi-Angle Hack Saw

- Blades: 12" (300mm)
- 4 Blades:
  - 1 - 5 Teeth per inch, 1 - 10 Teeth per inch,
  - 1 - 18 Teeth per inch, 1 - 24 Teeth per inch
- Multi-angle adjustment blade, 45°, 90°, 135° and 180°
- Spare blades storage frame



### T31005 Miniature Hack Saw

- Heavy duty one piece design in die cast aluminum
- Cuts metal, plastic and wood
- Compact and lightweight with 6" (150mm) blade



### T31010 Mini Hack Saw (Bow Style)

- Heavy duty one piece design in die cast aluminum
- Rubber grip for comfort and control
- Compact and lightweight
- Use with 7" (180mm) blade



### Hacksaw Blades

- 18 teeth per inch
- High carbon steel



### T31007 4pc Hacksaw Blade Set

- High carbon steel blades
- 2pc 12" blades (18 teeth per inch)
- 2pc 12" blades (24 teeth per inch)



Model	Size
T31018	6" 150mm (6pc / Set)
T31019	7" 170mm (6pc / Set)

### T31011 4pc Hacksaw Blade Set

- Bi-metal steel blades



### T31035 6" (150mm) Wallboard Saw - Plastic Handle

- Aggressive hard point, ultra sharp teeth
- Diamond ground induction hardened teeth
- Two way cutting on both the push and the pull
- No need for re-sharpening



Cushioned grip for comfort and control

### T31042 10-1/2" (265mm) Rapid Pull Saw

- Implus-hardened teeth stay sharp longer than non-hardened teeth
- Sharpened blade for fast, smooth cutting
- Cushioned grip for maximum comfort and control
- 15 teeth per inch



### T31043 10-1/2" (265mm) Rapid Pull Saw

- Implus-hardened teeth stay sharp longer than non-hardened teeth
- Sharpened blade for fast, smooth cutting
- Cushioned grip for maximum comfort and control
- 15 teeth per inch



### T31040 8" (210mm) Multi-Purpose Folding Retractable Saw

- Blade: 8" (210mm), 1.2mm (t), 13T/1"
- Made of high-performance alloy steel
- Triple-beveled teeth



### T31041 10" (250mm) Folding Rapid Pull Saw

- Blade: 10" (250mm), 11t/1", 1.5mm (t), high carbon steel blade
- Chrome plated, triple-bevel, impulse-hardening teeth
- 3-Section switch





### Professional Hand Saw

- Professional hand saw for woodworking and carpentry use
- SK5 high carbon steel has a precision ground with 3 sided razor teeth
- Lacquered surface treatment for lower friction and rust resistance
- Ideal for precise straight cut, cross cut or slant cut
- Ergonomic non-slip handle design for comfort and reducing fatigue

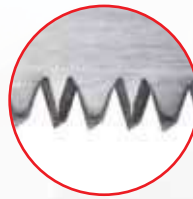

German impulse hardening technique on teeth for long last

Model	Size
<b>T31047</b>	20" 500mm
<b>T31048</b>	22" 560mm
<b>T31049</b>	24" 610mm



### Hand Saw - Plastic Handle

- Impulse-hardened teeth stay sharp longer than non-hardened teeth
- Sharpened blade for fast, smooth cutting
- Cushioned grip for maximum comfort and control
- 8 Teeth per inch

Model	Size
<b>T31021</b>	20" 500mm
<b>T31022</b>	22" 560mm
<b>T31023</b>	24" 610mm



### Hand Saw - Wood Handle

- Impulse-hardened teeth stay sharp longer than non-hardened teeth
- Sharpened blade for fast, smooth cutting
- Cushioned grip for maximum comfort and control
- 11 teeth per inch (for T31025)
- 8 teeth per inch (for T31026, T31027)

Model	Size
<b>T31025</b>	20" 500mm
<b>T31026</b>	22" 560mm
<b>T31027</b>	24" 610mm



### Back Saw - Plastic Handle

- Induction hardened teeth stay sharp longer than non-hardened teeth
- No need for re-sharpening
- 8 teeth per inch
- Diamond ground induction hardened teeth (for T31031)
- 8 and 14 point aggressive hard point (for T31031)

Model	Size
<b>T31030</b>	14" 355mm
<b>T31031</b>	14" 355mm (with curve teeth)







- 6 - 1/4" Dr. Bits:
- 2 - Slotted: 3/16", 1/4"
  - 2 - Phillips: #1, #2
  - 2 - Star: T15, T20

### T31009 Quick-Clamp Recip Saw & Bit Driver

- Includes metal and wood recip saw blades
- Bit driver with 6 screwdriver bits stored in handle
- Swivel head suitable for standard clip-on blades
- Large handgrip for secured grasp
- Hang hole for convenient storage
- Multi-angle positions for confined areas



Bits Stored in Handle



Standard Blade Clamp



Push Down to Change Angle



### T25802 560mm (22") Compound Miter Saw

- Push-knob design allows user to quickly adjust angle position
- 560mm (22") Capacity together with clamps, length gauge and positive angle location
- Slip-resistant grip for maximum comfort and control
- Induction-hardened teeth stay sharp
- Metric and inch graduation markings

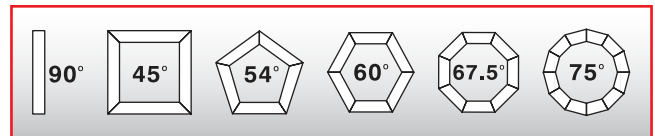

### T31050 12" (305mm) Miter Box - Plastic

- Two 45°, two 60°, and one 90° guides on the two edges with a side on 45° for larger sections of materials
- Great for crown moldings, casings and baseboards
- Molded front lip fits up against work table to reduce slippage
- Two screw holes on each side to secure base to work bench
- Made of high quality impact resistant ABS plastic material
- Can be use with either back or panel saws



### T25320 Ultrasonic Distance Detector

- Working range: 10m
- Wave length: 650nm
- Laser class 2: 1mw, w/ 1pc 9V battery



## Tape Measures

- Tape graduation on both sides
- Nylon coated tape for maximum durability
- Metal chrome with non-slip TPR case

Model	Size
<b>T25510</b>	3m x 16mm
<b>T25511</b>	5m x 19mm
<b>T25512</b>	7.5m x 25mm
<b>T25513</b>	8m x 25mm
<b>T25514</b>	12ft x 5/8"
<b>T25515</b>	16ft x 3/4"
<b>T25516</b>	25ft x 1"
<b>T25517</b>	33ft x 1"
<b>T25518</b>	3m / 10ft x 16mm / 5/8"
<b>T25519</b>	5m / 16ft x 19mm / 3/4"
<b>T25520</b>	7.5m / 25ft x 25mm / 1"



## Auto-Lock Tape Measures w/ Steel Case

- Auto-lock delivers maximum control and secures blade position
- Stainless steel, rubber enclosed case for improved resistance
- Push button brakes quickly retrieves blade

Model	Size
<b>T25490</b>	3m x 16mm
<b>T25491</b>	5m x 19mm
<b>T25492</b>	7.5m x 25mm
<b>T25495</b>	8m x 25mm
<b>T25497</b>	12ft x 5/8"
<b>T25493</b>	16ft x 3/4"
<b>T25494</b>	25ft x 1"
<b>T25498</b>	3m / 10ft x 16mm / 5/8"
<b>T25496</b>	5m / 16ft x 19mm / 3/4"



## Lighted Auto-Lock Tape Measures w/ Steel Case

- Nylon coated blade for maximum durability
- Stainless steel for improved resistance
- Non-slip rubber grip
- LED light for easy reading in dark areas
- 3 CR1225 Lithium button cell batteries included



Model	Size
<b>T25390</b>	3m x 19mm
<b>T25391</b>	5m x 19mm
<b>T25392</b>	7.5m x 25mm
<b>T25393</b>	8m x 25mm





## Tape Measures

- Special heat-treated steel tape
- Locking device secures blade
- Impact resistant plastic case with belt clip

Model	Size
(A) <b>T25400</b>	3m x 13mm
(B) <b>T25401</b>	5m x 19mm
<b>T25402</b>	7.5m x 25mm
<b>T25403</b>	8m x 25mm
<b>T25404</b>	10m x 25mm
<b>T25406</b>	16ft x 3/4"
<b>T25407</b>	25ft x 1"
<b>T25408</b>	33ft x 1"
<b>T25409</b>	5m / 16ft x 19mm / 3/4"
<b>T25410</b>	7.5m / 25ft x 25mm / 1"



## Tape Measures

Model	Size
<b>T25411</b>	16ft x 3/4"
<b>T25413</b>	25ft x 1"
<b>T25414</b>	33ft x 1-1/4"
<b>T25415</b>	3m x 16mm
<b>T25416</b>	5m x 19mm
<b>T25417</b>	7.5m x 25mm
<b>T25418</b>	3m / 10ft x 16mm / 5/8"
<b>T25419</b>	5m / 16ft x 19mm / 3/4"
<b>T25412</b>	7.5m / 25ft x 25mm / 1"



## Tape Measures

Model	Size
<b>T25380</b>	3m x 16mm
<b>T25381</b>	5m x 19mm
<b>T25382</b>	7.5m x 25mm
<b>T25383</b>	8m x 25mm
<b>T25384</b>	12ft x 5/8"
<b>T25385</b>	16ft x 3/4"
<b>T25386</b>	25ft x 1"
<b>T25387</b>	33ft x 1"



## Auto-Lock Tape Measures

Model	Size
<b>T25370</b>	3m x 16mm
<b>T25371</b>	5m x 19mm
<b>T25372</b>	7.5m x 25mm
<b>T25373</b>	8m x 25mm
<b>T25374</b>	12ft x 5/8"
<b>T25375</b>	16ft x 3/4"
<b>T25376</b>	25ft x 1"
<b>T25377</b>	33ft x 1"



## Closed Reel Tape Measure

- High impact-resistant plastic case withstands rugged conditions
- Rubber, slip-resistant grip ensures firm hold

Model	Size	Blade
<b>T25900</b>	20m x 15mm	Fiberglass
<b>T25901</b>	30m x 15mm	Fiberglass
<b>T25904</b>	20m / 66ft x 15mm / 19/32"	Fiberglass
<b>T25905</b>	30m / 100ft x 15mm / 19/32"	Fiberglass
<b>T25910</b>	20m x 13mm	Steel
<b>T25911</b>	30m x 13mm	Steel
<b>T25914</b>	20m / 66ft x 13mm / 1/2"	Steel
<b>T25915</b>	30m / 100ft x 13mm / 1/2"	Steel



**T25900**

**T25910**

## Auto-Return Closed Reel Fiberglass Tape Measure

- 13mm Wide fiberglass blade
- Auto-return construction for easy storing
- Rubber, slip-resistant grip ensures firm hold



Model	Size
<b>T25920</b>	30m x 13mm
<b>T25922</b>	30m / 100ft x 13mm / 1/2"

## Closed Reel Fiberglass Tape Measures



Model	Size
<b>T25926</b>	30m x 13mm
<b>T25927</b>	50m x 13mm
<b>T25930</b>	30m / 100ft x 13mm / 1/2"
<b>T25931</b>	50m / 165ft x 13mm / 1/2"

## Open Reel Fiberglass Tape Measures



Model	Size
<b>T25936</b>	20m x 13mm
<b>T25937</b>	30m x 13mm
<b>T25938</b>	50m x 13mm
<b>T25942</b>	20m / 66ft x 13mm / 1/2"
<b>T25943</b>	30m / 100ft x 13mm / 1/2"
<b>T25944</b>	50m / 165ft x 13mm / 1/2"

## Open Reel Steel Tape Measures



Model	Size
<b>T25950</b>	30m / 100ft x 13mm
<b>T25951</b>	50m / 165ft x 13mm
<b>T25954</b>	30m / 100ft x 13mm / 1/2"
<b>T25955</b>	50m / 165ft x 13mm / 1/2"

## 4x Speed Open Reel Steel Tape Measures



Model	Size
<b>T25960</b>	30m x 13mm
<b>T25961</b>	50m x 13mm
<b>T25964</b>	30m / 100ft x 13mm / 1/2"
<b>T25965</b>	50m / 165ft x 13mm / 1/2"

## Stainless Steel Rulers

- Graduated 0-150mm
- Includes depth gauge pocket clip



Model	Size
<b>T73483</b>	150mm

## Stainless Steel Straight Rulers



Model	Size
<b>T29216</b>	12" (300mm x 30mm)
<b>T29217</b>	24" (600mm x 30mm)
<b>T29218</b>	40" (1000mm x 35mm)

19

## Level Rulers

- Aluminum straight edge with metric graduations and sliding carriers incorporating horizontal and vertical vials
- Ideal for marking center points and equal distances when drilling holes for items that require more than one fixing at the same level



Model	Size
<b>T29235</b>	600mm
<b>T29236</b>	750mm
<b>T29237</b>	1000mm

## Mitre Square w/ Level

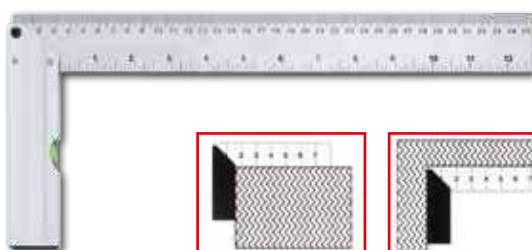

Model	Size
<b>T29213</b>	150mm
<b>T29214</b>	200mm
<b>T29215</b>	300mm

Outside Square

Inside Square

Mitre Square

- Aluminium handle
- Stainless steel blade

**T29206 300mm Combination Square**

- Aluminium handle with sliding level vial

**T29240 8" (200mm) Sliding Bevel with Vial**

- Molded plastic nonslip stock with tempered steel blade

**T25538 3 Vial Post Spirit Level**

- Excellent tool to plumb pipes, posts and other applications where vertical or horizontal leveling is required

**T25540 Extendable Spirit Level (800 - 1200mm)**

- Extruded aluminum box section level with extendable main body construction
- Extendable from 800mm (32") to 1200mm (48")

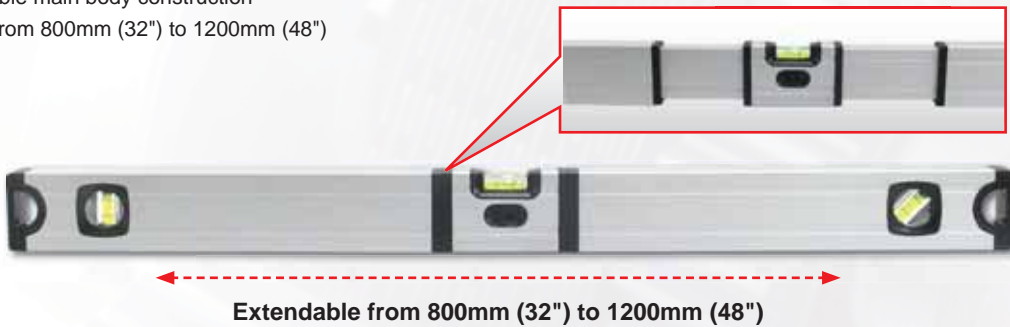
**T25432 800mm (32") Combination Level**

- Built from a single piece of aluminum extrusion for increased durability and rugged use

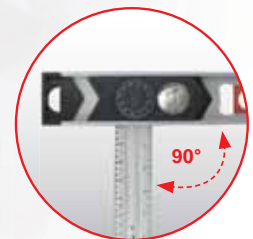
**T25580 600mm (24") Ruler Angle Level w/ Laser**

- Wave length: 650nm
- Laser power: <1mw
- Self leveling range:  $\pm 3^\circ$
- Voltage: 3V



2 Laser Lines

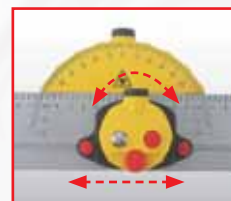

Free rotation and movement



Rotate and push to expose the nails







### T25545 LCD Display Digital Level with Laser (24", 600mm)

- Digital accuracy:  $\pm 0.10^\circ$ , from  $0^\circ$  to  $90^\circ$
- Simple to calibrate
- Reads in degrees or percent
- Voltage: 9V



Laser Line



Angle Measure Mode



Percentage Measure Mode



Temperature Measure Mode



Display Inverts When Inverted

### T25536 9" (230mm) Line Level

- Soft rubber borders, protect the product from bumping



### T25430 230mm Aluminum Torpedo Level

- Aluminum die cast frame with strong magnet
- Quickly measure drainage slope from 0-6 Degree
- Measuring scale indicators



### Professional Aluminum Level

- Aluminum box section extrusion with milled top and base



Model	Size
T25433	400mm 16"
T25434	600mm 24"
T25435	800mm 32"
T25437	1000mm 40"
T25438	1200mm 48"
T25439	1800mm 72"



Rubber End

## High Accuracy Spirit Level

- Soft rubber borders, protect from bumping

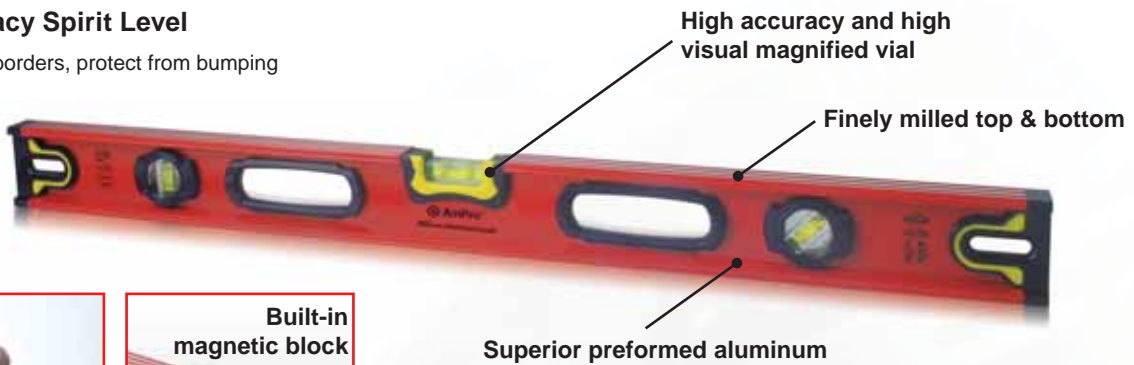

**Built-in magnetic block**

**Superior preformed aluminum**

Model	Size
<b>T25550</b>	350mm 14"
<b>T25551</b>	400mm 16"

Model	Size
<b>T25552</b>	500mm 20" (Hollow Handle)
<b>T25553</b>	600mm 24" (Hollow Handle)
<b>T25554</b>	800mm 32" (Hollow Handle)
<b>T25555</b>	1000mm 40" (Hollow Handle)
<b>T25556</b>	1200mm 48" (Hollow Handle)

## T25431 5-in-1 Multi-Function Level (800mm, 32")

- Aluminum box section extrusion with milled top and base



**Vertical & Horizontal Laser Line**



**Wire Detector**



**Wood Detector**



**Movable Marker for Drawing Equidistant Points**



**Pins with Safety Lock for Easy Positioning**

## T25587 6V Self Leveling Laser Level

- Accuracy of Vials: 0.5mm/m
- Laser Output Power: < 1mw
- Visible Red Light λ=635nm
- Laser Class: II
- Protection Class: III
- Projects horizontal, vertical and crossed lasers
- Beeps when laser is shaking (use only when the laser is stable)
- Rubber cover for comfortable handling
- On / Off Button w/ unlock / lock function
- Stainless metal surface for easy cleaning





### T25582 Laser Level Square

- Working range: up to 6 meters, recommended use: indoors, laser output power: < 1mw , visible red light  $\lambda = 650\text{nm}$ , protection class II, w/ 2pc AA battery



### T13160 30m 3-Speed Gear Chalk Line w/ Soft Grip

- Fast, easy push-button line release
- Large chalk capacity and an easy pop-in line refill
- Locking handle allows tool to be used as a plumb bob



### T27990 12oz. Plumb Bob

- Ideal for use in framing, deck building, plumbing and construction applications
- Screw top simplifies attachment of string to center of the plumb
- Hardened steel tip for long life
- Rust resistant
- Weight: 12oz.



### T13162 30m Chalk Line and Marking Chalk

- Sturdy zinc case with self-locking metal handle
- Palm-size zinc case for sure grip
- Micro-fine marking powder makes a perfect line every time



19

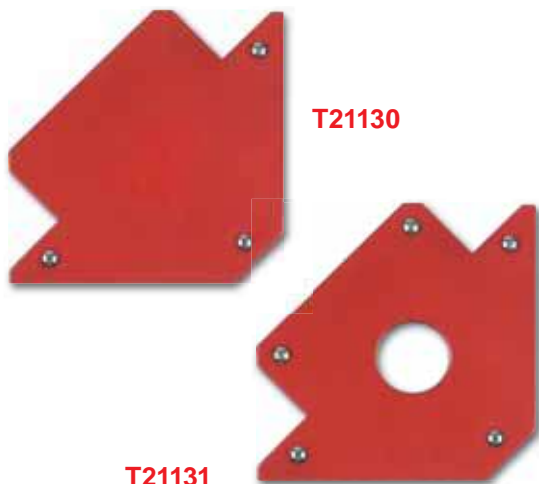

T21130

T21131

### Arrow Magnetic Welding Holder

- Premium quality materials
- Powerful magnet
- 45° / 90° / 135° Angle

### T21130 Arrow Magnetic Welding Holder (Up To 25lb)

- Used indoors, up to 25 lbs of smooth steel can be lifted

### T21131 Arrow Magnetic Welding Holder (Up To 50lb)

- Used indoors, up to 50 lbs of smooth steel can be lifted

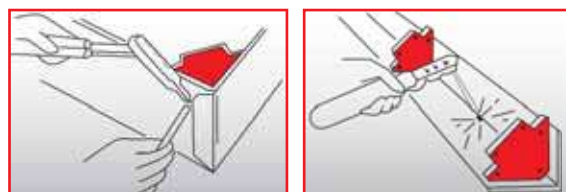



## 6" Tri-Fold Measuring Wheel

- Precise & lightweight
- Easy to carry & store
- Balanced, inline design
- Sturdy tri-fold handle with TPR pistol grip
- Trigger brake and counter control at the handle
- Hi-traction PU tire
- Measure to 9999.9ft (or 9999.9m)
- Wheel Diameter: 6" (158.7mm)
- Extended Size: 41" (1040mm)
- Storage Size: 17" (430mm)

Model	Size	Min.Distance	Max.Distance
<b>T25570</b>	SAE	1 inch	10,000 ft
<b>T25571</b>	Metric	10 cm	10,000 Meter



## T25335 Non-Contact Infrared Thermometer

- Measures surface temperature without contact
- Features laser pointer
- Ideal for checking temperature of heater vents, A/C units, engines, mufflers, tires, brakes and more
- Class IIIA laser tool is manufactured to comply with CFR 21, parts 1040.10 and 1040.11

Max. Power Output	< 5mw
Wavelength	630 - 660nm
Temperature Range	-4° to 608°F / -20° to 320°C
Accuracy	±2°C (±3°F) or 2%

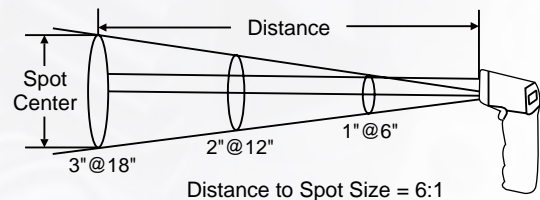
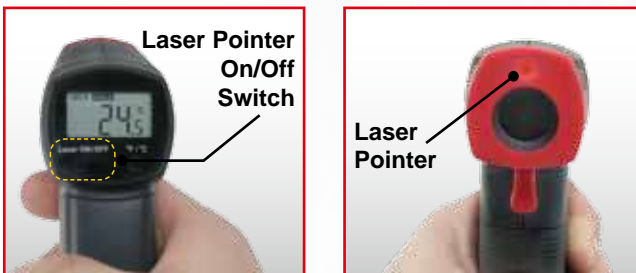

**Warning**  
 Avoid Exposure  
 Laser radiation is emitted through the aperture  
 Laser radiation - Avoid direct eye exposure



### T29572 Heavy Duty Leather Punch

- Hardened and tempered carbon steel hole punches with brass anvil
- High leverage handle for added comfort
- Unique plastic waste box with removable lid
- Contents: 2, 2.5, 3, 3.5, 4, 4.5mm



### T30905 Heavy Duty Swivel Head Hand Riveter

- 360° swivel-head design
- Spring loaded pivoting jaw for firm grip
- 4 Quick-switch settings, screw-in nozzle sizes: 3/32" (2.4mm), 1/8" (3.2mm), 5/32" (4.0mm), 3/16" (4.8mm)
- Nozzles housed in handle for easy selection



### T30900 Heavy Duty Hand Riveter

### T30901 Heavy Duty Hand Riveter

- Heat-treated, heavy duty steel construction
- Spring loaded pivoting jaw for firm grip
- Laminated steel for high strength
- Contoured handle for comfort
- 4 quick-switch settings, screw-in
- Nozzle sizes: 3/32" (2.4mm), 1/8" (3.2mm), 5/32" (4.0mm), 3/16" (4.8mm)
- Nozzles housed in handle for easy selection

19



### T29666 10pc Heavy Duty Hollow Punch Kit

- Heat treated, heavy duty steel construction
- Contents:
  - 10 - Hollow Punch Kit:
    - 5, 6, 8, 10, 12.7, 16, 20, 25, 32mm, 22mm x 120mm Rod



### T14324 7" (180mm) Pressure Adjustable Power Clamp

- Power ratchet clamp gear design
- Slide-lock mechanism for quick positioning and releasing
- Contoured, cushioned handle offers firm, comfortable grip under pressure
- Pivoting jaw ends secure both flat and shaped workpieces
- Thermoplastic rubber ends to avoid scratch on work pieces



### T14323 9" (230mm) Adjustable Power Ratchet Clamp

- Power ratchet clamp gear design
- Slide-lock mechanism for quick positioning and releasing
- Contoured, cushioned handle offers firm, comfortable grip under pressure
- Pivoting jaw ends secure both flat and shaped workpieces
- Thermoplastic rubber ends to avoid scratch on work pieces



### T14361 2pc 9" (230mm) Power Clamp Set

- Use as much pressure as needed
- Patented design allows control of clamping pressure
- Swivel pads pivot for a uniform secure grip



### Steel Bar Clamps (F-Clamp)

- Precision die cast iron frame
- Nickel plated, carbon steel shaft and center screw
- Swivel, rubber jaw prevents damage to surface



Model	Size	
T14330	3-1/8" x 6"	(80mm x 150mm)
T14331	4" x 15-3/4"	(100mm x 400mm)
T14332	4-3/4" x 20"	(120mm x 500mm)
T14333	4-3/4" x 24"	(120mm x 600mm)
T14334	2" x 6"	(50mm x 150mm)
T14335	3-1/8" x 8"	(80mm x 200mm)





### Combination Quick Lever Bar Clamp / Vise

- Exerts up to 320kgs / 700Lbs of clamping pressure
- Alloy body for industrial / professional use
- Non-marring pads grip firmly and protect work
- Forms simple vise
- 7 x 22mm Plated, round-edge high quality rail steel
- Ideal for clamping, holding work for sawing, drilling, welding, gas welding, etc.

Model	Size
<b>T14336</b>	6" 150mm
<b>T14337</b>	12" 305mm
<b>T14338</b>	18" 450mm
<b>T14339</b>	24" 610mm



Versatile swivel pad fits angular workpieces

### Swivel Quick-Ratcheting Bar Clamp



Model	Size
<b>T14326</b>	6" 150mm
<b>T14327</b>	12" 305mm
<b>T14328</b>	18" 450mm
<b>T14329</b>	24" 610mm

### T14321 12" (300mm) Quick-Ratcheting Bar Clamp

- Pistol grip for single-handed operation
- Quick-release button for fast jaw positioning
- Easily converts to a spreader
- Durable, lightweight, versatile design for various applications



### T14355 3/4" Pipe Clamp/Spreader

- Clamping faces 2-3/8" x 2" (60mm x 52mm)
- 2-3/8" Clamping reach from edge of pipe
- Two side sliding design system
- Tail-stop w/ multiple disc clutch
- Fits all 3/4" pipe tube
- Ductile steel



\* Pipe not included





### T73601 9" Caulking Gun

- Pistol grip, quick release
- All metal frame
- Quick-release trigger
- Use with standard size cartridges up to 9" (225mm)



### T73605 9" Caulking Gun

- Quick-release trigger
- Use with standard size cartridges up to 9" (225mm)



### Nut Splitting Tool

- Removes rusted and corroded nuts
- Heat-treated steel chisel

Model	Size
T72119	Nut Splitting Tool 1/2" - 5/8"
T72120	Nut Splitting Tool 5/8" - 7/8"
T72118	2pc Nut Splitting Tool Set



### T72117 Nut Splitter

- Removes rusted and corroded nuts
- High grade, heat-treated alloy steel
- Splits nuts up to 1/2" across flat
- Use with 3/4" Dr. wrench for more torque





### T72121 4pc Nut Splitter Set

- Removes rusted and corroded nuts
- Heat treated steel chisel
- Chrome plated for rust resistance
- 4 most popular sizes all-in-one set
- Sizes:  
5/16" - 1/2" (9 - 12mm), 1/2" - 5/8" (12 - 16mm)  
5/8" - 7/8" (16 - 22mm), 7/8" - 1-1/8" (22 - 27mm)



### T72123 Nut Splitter

- Removes rusted and corroded nuts
- 360° Rotating cutter bit splits nuts without damaging bolt
- Angled handle design allows access to hard-to-reach areas
- Fits nut sizes 7/16" through 3/4"
- Use with 3/4" Dr. wrench for more torque



### T73925 Stud Remover and Installer

- Removes and installs tight studs in confined areas
- Capacity: 1/4" to 3/4" diameter
- 1/2" Dr.



### T75932 Hydraulic Nut Splitter Set

- Special hydraulic nut splitter design removes the most stubborn rusted or corroded nuts
- Heavy duty construction, Chrome Molybdenum steel splitter bodies and blades
- Includes:  
2 - Hydraulic Ram and Attachment  
5 - Splitters with Blade  
1 - Nut  
1 - Oil Bottle



## Power Pullers

### (A) Power Puller (Single-Gear)

Model	Capacity	Specification
<b>T29180</b>	2 Ton	Cable Dia. 5mm x 12ft w/ 2 hooks
<b>T29181</b>	4 Ton	Cable Dia. 6mm x 12ft w/ 3 hooks

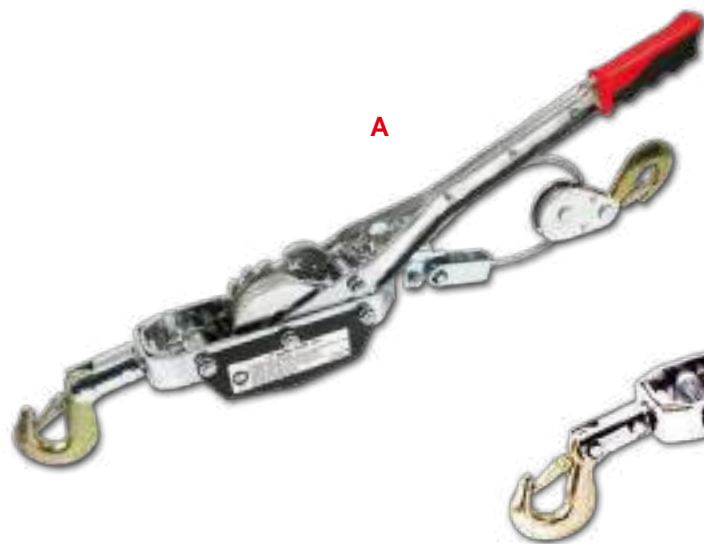

### (B) Heavy Duty Power Puller (Double-Gear)

Model	Capacity	Specification
<b>T29185</b>	2.5 Ton	Cable dia. 5mm x 10ft w/ 2 hooks
<b>T29186</b>	4 Ton	Cable dia. 6mm x 10ft w/ 3 hooks

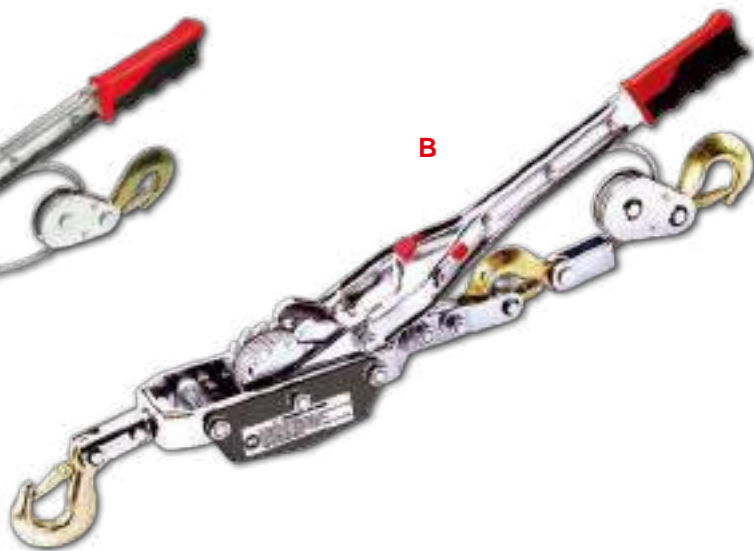

## Ratchet Tie Downs

- Secures cargo that requires greater tensioning and holding force
- Ideal for large and heavy loads



Model	<b>T37002</b>	<b>T37003</b>	<b>T37004</b>	<b>T37001</b>	<b>T37005</b>
Size	1" x 15ft (4.5m)	1" x 16ft (5m)	1-1/2" x 19ft (6m)	2" x 25ft (7.5m)	2" x 29.5ft (9m)
Capacity	1,500 lbs (680kgs)	880 lbs (400 kgs)	4,409 lbs (2,000 kgs)	5,000 lbs (2,268 kgs)	11,023 lbs (5,000 kgs)



### T12815 Utility & Fingernail Brush w/ Magnet

- Double-sided brush for general purpose scrubbing & fingernail cleaning
- Grooved body handle for better grip & comfort



### T12810 3pc Brush Set

- Multi-purpose wire brushes great for removing rust, dirt and paint
- Stainless steel, copper and nylon bristles to clean a wide-variety of materials
- Long narrow structural foam handle w/ finger grips
- 18cm (7") long



### T12812 Carbon Steel Wire Brush w/ Scraper

- 3 x 19 rows steel bristles
- Solvent proof, hardened and ground steel scraper
- 36cm (14") long

### T12813 Stainless Steel Wire Brush w/ Scraper

- 3 x 19 rows steel bristles
- Solvent proof, hardened and ground steel scraper
- 36cm (14") long

### T12814 Brass Wire Brush w/ Scraper

- 3 x 19 rows brass bristles
- Solvent proof, hardened and ground steel scraper
- 36cm (14") long



### T27928 Hand Drill

- Bit storage in handle
- Double pinion steel gears for smooth operation
- 8mm (5/16") Chuck capacity

### T12800 Carpenter's Ratchet Brace

- 12-point reversible ratchet
- Jaws designed to hold 1/8" to 7/16" shank bits, as well as tapered shanks
- Tough molded head and handle
- 2-Jaw chunk





# Engineering Tools

A Comprehensive Range  
of Essential Tools







## Pro Style File

- Pro style handle
- Bastard cut
- Drop-forged, heat-treated steel

### Flat File



Model	Size
<b>T18416</b>	8" 200mm
<b>T18451</b>	10" 250mm

### Round File



Model	Size
<b>T18417</b>	8" 200mm
<b>T18452</b>	10" 250mm

### Three-Square File



Model	Size
<b>T18418</b>	8" 200mm
<b>T18453</b>	10" 250mm

### Half-Round File



Model	Size
<b>T18419</b>	8" 200mm
<b>T18454</b>	10" 250mm

### Square File



Model	Size
<b>T18420</b>	8" 200mm
<b>T18455</b>	10" 250mm

### T18405 3pc 8" (200mm) Pro Style File Set

- 1 - 8" (200mm) Flat File
- 1 - 8" (200mm) Round File
- 1 - 8" (200mm) Half-Round File



### T18406 4pc 8" (200mm) Pro Style File Set

- 1 - 8" (200mm) Flat File
- 1 - 8" (200mm) Round File
- 1 - 8" (200mm) Three-Square File
- 1 - 8" (200mm) Half-Round File





### T18446 3mm 13pc Exchangable Needle File Set

- Contents:  
Handle Assembly with Collet, Crossing File, Round File, Half Round File, Flat File, Knife File, Three-Square File, Square File, Barrette File, Joint File, Slitting File, Marking File, Equaling File



### T18447 5mm 13pc Exchangable Needle File Set

- Contents:  
Handle Assembly with Collet, Crossing File, Round File, Half Round File, Flat File, Knife File, Three-Square File, Square File, Barrette File, Joint File, Slitting File, Marking File, Equaling File



### T18410 4pc 8" (200mm) Pro Style File Set

- Contents:  
1 - 8" (200mm) Round File  
1 - 8" (200mm) Mill File  
1 - 8" (200mm) Three-square File  
1 - 8" (200mm) Half-round File



Model	Size
T18421	6" (150mm) Round File
T18422	6" (150mm) Mill File
T18423	6" (150mm) Three-square File
T18424	6" (150mm) Half-round File

### C-Clamps

Model	Size
T14302	4" 100mm
T14304	6" 150mm
T14305	8" 200mm
T14306	10" 250mm
T14309	3pc C-Clamp Set 1", 2", 3" (25mm, 50mm, 75mm)



### Adjustable C-Clamps

- Precision die cast iron frame
- Swivel pad allows for easy clamping with angled workpieces



Model	Size
T14307	2" - 3" (50 - 75mm)
T14308	4" - 7" (100 - 180mm)





### Stainless Steel Vernier Caliper

- Makes outside, inside, step base and depth measurements
- Ranges 0 to 6" in .001" increments, .100" range/revolution
- Adjustable dial and thumb wheel fine adjustments

Model	Range
<b>T74611</b>	0 - 150mm (6")
<b>T74617</b>	0 - 200mm (8")
<b>T74619</b>	0 - 300mm (12")

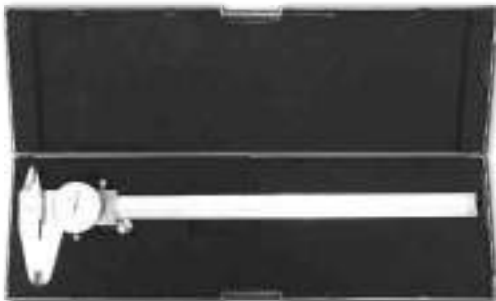

### Stainless Steel Dial Vernier Caliper

- Measures internal, external, depth and step dimensions
- Fine adjustment control with thumb lock
- Hardened stainless steel for superior durability
- Satin finish with fine engraved scales
- Plastic case with fitted padding for safe storage

Model	Range
<b>T74613</b>	0 - 150mm (6")
<b>T74620</b>	0 - 200mm (8")
<b>T74622</b>	0 - 300mm (12")



### Stainless Steel Digital Caliper

- Makes outside, inside, step base and depth measurements
- Ranges 0 to 6" in .0005" resolution
- Easy-to-read LCD panel
- Instant SAE/Metric conversion
- Zero setting at any position within measuring range
- Thumb wheel fine adjustment

Model	Range
<b>T74615</b>	0 - 150mm (6")



### Digital Outside Micrometer

- 0 to 1" (25mm) capacity
- Accuracy 0.0005" (0.001mm)
- Easy-to-read LCD panel
- Instant SAE/Metric conversion
- Zero setting at any position within measuring range
- Ratcheting knob construction

Model	Range
<b>T74616</b>	0 - 25mm (1")



**T38724 6-1/2" Hobby Woodworker's Vise**

- Clamp tape: 0.1mm HT150
- Castiron, N.W: 3.5KGS
- Black oxide finish handle and lead screw

**T38726 9LB Anvil**

- HT150, N.W: 4KGS
- Single bick cast iron anvil

**T38718 Heavy Duty 3" (76mm) Clamp Vise**

- Clamp Tape: 0.1mm HT150
- N.W: 2KGS
- Cast iron with serrated curved jaws
- Black oxide finish handle and lead screw

**T38720 4" (102mm) Flat Drill Press Vise**

- Clamp tape: 0.1mm HT150
- N.W: 3KGS
- Manufactured from cast iron with fully hardened jaws
- Black oxide finish handle and lead screw

**T38721 3-1/2" Angle Drill Press Vise**

- Clamp tape: 0.1mm HT150 Powder Coated
- Cast iron
- Black oxide finish handle and lead screw

**Heavy Duty All Steel Bench Vise**

- Fixed base

**Heavy Duty All Steel Bench Vise**

- 360° Swivel base

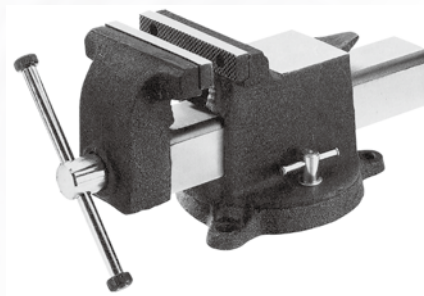

Model	Size	Throat Depth	Anvil
<b>T38700</b>	4"	2-1/4" (57mm)	52 x 62mm
<b>T38701</b>	5"	2-5/8" (67mm)	75 x 77mm
<b>T38702</b>	6"	3" (76mm)	77 x 78mm
<b>T38703</b>	8"	3-1/2" (89mm)	95 x 96mm
<b>T38704</b>	10"	4" (101mm)	94 x 95mm

Model	Size	Throat Depth	Anvil
<b>T38709</b>	4"	2-1/4" (57mm)	52 x 62mm
<b>T38710</b>	5"	2-5/8" (67mm)	75 x 77mm
<b>T38711</b>	6"	3" (76mm)	77 x 78mm
<b>T38712</b>	8"	3-1/2" (89mm)	95 x 96mm
<b>T38713</b>	10"	4" (101mm)	94 x 95mm



### Taps

- Heavy duty alloy steel



Model	Size	Model	Size
<b>T35931</b>	M3 x 0.5	<b>T35962</b>	M14 x 1.25
<b>T35934</b>	M4 x 0.7	<b>T35964</b>	M14 x 2
<b>T35936</b>	M5 x 0.8	<b>T35967</b>	M16 x 2
<b>T35939</b>	M6 x 1.0	<b>T35968</b>	M18 x 1
<b>T35943</b>	M8 x 1.0	<b>T35969</b>	M18 x 1.5
<b>T35950</b>	M10 x 1.25	<b>T35970</b>	M18 x 2
<b>T35951</b>	M10 x 1.5	<b>T35971</b>	M18 x 2.5
<b>T35959</b>	M12 x 1.5		
<b>T35960</b>	M12 x 1.75		

### Dies

- Heavy duty alloy steel



Model	Size
<b>T36011</b>	M3 x 0.5
<b>T36014</b>	M4 x 0.7
<b>T36016</b>	M5 x 0.8
<b>T36019</b>	M6 x 1.0
<b>T36024</b>	M8 x 1.25
<b>T36031</b>	M10 x 1.5
<b>T36040</b>	M12 x 1.75

### Die Holders

- Zinc alloy steel



Model	Size
<b>T36280</b>	16 x 5mm
<b>T36281</b>	20 x 5mm
<b>T36282</b>	20 x 7mm
<b>T36283</b>	25 x 9mm
<b>T36284</b>	30 x 11mm
<b>T36285</b>	38 x 14mm

### Taps

- HSS



Model	Size	Model	Size
<b>T36101</b>	M3 x 0.5	<b>T36143</b>	M20 x 1.5
<b>T36104</b>	M4 x 0.7	<b>T36144</b>	M20 x 2
<b>T36106</b>	M5 x 0.8	<b>T36145</b>	M20 x 2.5
<b>T36109</b>	M6 x 1.0	<b>T36146</b>	M22 x 1
<b>T36113</b>	M8 x 1.0	<b>T36147</b>	M22 x 1.5
<b>T36120</b>	M10 x 1.25	<b>T36148</b>	M22 x 2
<b>T36121</b>	M10 x 1.5	<b>T36149</b>	M22 x 2.5
<b>T36129</b>	M12 x 1.5	<b>T36150</b>	M24 x 1
<b>T36130</b>	M12 x 1.75	<b>T36151</b>	M24 x 1.5
<b>T36132</b>	M14 x 1.25	<b>T36152</b>	M24 x 2
<b>T36134</b>	M14 x 2	<b>T36153</b>	M24 x 3
<b>T36137</b>	M16 x 2	<b>T36154</b>	M27 x 1
<b>T36138</b>	M18 x 1	<b>T36155</b>	M27 x 1.5
<b>T36139</b>	M18 x 1.5	<b>T36156</b>	M27 x 2
<b>T36140</b>	M18 x 2	<b>T36157</b>	M27 x 3
<b>T36141</b>	M18 x 2.5	<b>T36158</b>	M30 x 3.5
<b>T36142</b>	M20 x 1		

### Dies

- HSS



Model	Size
<b>T36181</b>	M3 x 0.5
<b>T36184</b>	M4 x 0.7
<b>T36186</b>	M5 x 0.8
<b>T36189</b>	M6 x 1.0
<b>T36194</b>	M8 x 1.25
<b>T36201</b>	M10 x 1.5
<b>T36210</b>	M12 x 1.75

### Tap Wrenches

- Zinc alloy steel



Model	Size	Range
<b>T36260</b>	#0	1/16" - 1/8" (M1- M8)
<b>T36261</b>	#1	1/16" - 1/4" (M1- M10)
<b>T36262</b>	#1	1/16" - 1/2" (M1- M12)
<b>T36263</b>	#2	5/32" - 1/2" (M4- M12)

### T35903 29pc Metric Tap & Die & Drill Set

- Contents:
  - 10 - Taps (Heavy Duty Alloy Steel) :  
M5 x 0.8, M5 x 0.9, M6 x 0.75, M6 x 1.0, M8 x 1.0,  
M8 x 1.25, M10 x 1.25, M10 x 1.5, M12 x 1.5, M12 x 1.75
  - 10 - Dies (HSS) :  
M5 x 0.8, M5 x 0.9, M6 x 0.75, M6 x 1.0, M8 x 1.0,  
M8 x 1.25, M10 x 1.25, M10 x 1.5, M12 x 1.5, M12 x 1.75
  - 5 - Drills (HSS) :  
4.2, 5.0, 6.8, 8.6, 10.3mm
  - 1 - NPT Tap: 1/8 - 27
  - 1 - NPT Die: 1/8 - 27
  - 1 - Tap Wrench: M3 - M12
  - 1 - Die Wrench: 25mm (1") O/D



### T35902 24pc Metric Tap & Die Set

- Contents:
  - 10 - Taps (Heavy Duty Alloy Steel) :  
M5 x 0.8, M5 x 0.9, M6 x 1.0, M6 x 0.75, M8 x 1.0,  
M8 x 1.25, M10 x 1.5, M10 x 1.25, M12 x 1.5, M12 x 1.75
  - 10 - Dies (HSS) :  
M5 x 0.8, M5 x 0.9, M6 x 1.0, M6 x 0.75, M8 x 1.0,  
M8 x 1.25, M10 x 1.5, M10 x 1.25, M12 x 1.5, M12 x 1.75
  - 1 - NPT Tap: 1/8 - 27
  - 1 - NPT Die: 1/8 - 27
  - 1 - Tap Wrench: M3 - M12
  - 1 - Die wrench: 25mm (1") O/D



### T35904 17pc Metric Tap & Die Set

- Contents:
  - 5 - Taps (Heavy Duty Alloy Steel) :  
M5 x 0.8, M6 x 1, M8 x 1.25, M10 x 1.5, M12 x 1.75
  - 5 - Dies (HSS) :  
M5 x 0.8, M6 x 1, M8 x 1.25, M10 x 1.5, M12 x 1.75
  - 5 - Drills (HSS) :  
4.2, 5, 6.8, 8.6, 10.3mm
  - 1 - Tap Wrench: M3 - M12
  - 1 - Die Handle: 25mm (1") O/D



### T35905 12pc Metric Tap & Die Set

- Contents:
  - 5 - Taps (Heavy Duty Alloy Steel) :  
M6 x 1.0, M7 x 1.0, M8 x 1.25, M10 x 1.5, M12 x 1.75
  - 5 - Dies (HSS) :  
M6 x 1.0, M7 x 1.0, M8 x 1.25, M10 x 1.5, M12 x 1.75
  - 1 - Tap Wrench: M3 - M12
  - 1 - Die Handle: 25mm (1") O/D







### T35900 39pc Tap & Die Set



- Quickly restores or creates internal/external threads
- Threads in a wide range of sizes
- Contents:
  - 16 - Taps (Heavy Duty Alloy Steel) :
    - M3 x 0.5, M3 x 0.6, M4 x 0.7, M4 x 0.75, M5 x 0.8, M5 x 0.9, M6 x 0.75, M6 x 1.0, M7 x 0.75, M7 x 1.0, M8 x 1.0, M8 x 1.25, M10 x 1.25, M10 x 1.5, M12 x 1.5, M12 x 1.75
  - 16 - Dies (Heavy Duty Alloy Steel) :
    - M3 x 0.5, M3 x 0.6, M4 x 0.7, M4 x 0.75, M5 x 0.8, M5 x 0.9, M6 x 0.75, M6 x 1.0, M7 x 0.75, M7 x 1.0, M8 x 1.0, M8 x 1.25, M10 x 1.25, M10 x 1.5, M12 x 1.5, M12 x 1.75
  - 2 - NPT Tap & Die: 1/8" - 27
  - 1 - Tap Wrench: M3 - M12
  - 1 - T-Handle Tap Wrench
  - 1 - Die Handle: 25mm (1") O/D
  - 1 - Screw Pitch Gauge
  - 1 - Slotted Screwdriver

### T35907 18pc Metric Tap & Drill Set

- Contents:
  - 9 - Taps (Heavy Duty Alloy Steel) :
    - M3 x 0.5, M4 x 0.7, M5 x 0.8, M6 x 1.0, M7 x 1.0, M8 x 1.25, M9 x 1.25, M10 x 1.5, M12 x 1.75
  - 9 - Drills (HSS) :
    - 2.5, 3.3, 4.2, 5, 6.8, 7.8, 8.6, 10.3mm



### T35906 10pc Metric Tap & Die Set

- Contents:
  - 4 - Taps (Heavy Duty Alloy Steel) :
    - 3, 4, 5, 6mm
  - 4 - Dies: (HSS)
    - 3, 4, 5, 6mm
  - 1 - Die Wrench: 25mm (1") O/D
  - 1 - T-Type Tap Wrench: M3 - M6

### T35920 10pc Metric Tap Set

- Contents:
  - 10 - Taps (Heavy Duty Alloy Steel) :
    - M6 x 1.0, M7 x 1.0, M8 x 1.25, M8 x 1.0, M10 x 1.5, M10 x 1.25, M10 x 1.0, M12 x 1.75, M12 x 1.5, M12 x 1.25

### T35926 6pc Metric Die Set

- Contents:
  - 5 - Dies (HSS) :
    - 6, 7, 8, 10, 12mm
  - 1 - Die Wrench: 25mm (1") O/D





# Electricians & Plumbing Tools







## Electric Glue Guns



### T20102 5 - 20W Pistol Grip Mini Glue Gun

- Electric heating system
- Trigger feed mechanism controls glue flow
- High impact housing for durability
- Non-slip pad for secured grip
- Built-in stand
- Mini size excellent for confined areas



### T20103 7 - 55W Pistol Grip Mini Glue Gun

- Electric heating system
- Trigger feed mechanism controls glue flow
- High impact housing for durability
- Built-in stand
- Mini size excellent for confined areas



### T20104 11 - 60W Pistol Grip Glue Gun

- Electric heating system
- Trigger feed mechanism controls glue flow
- High impact housing for durability
- Built-in stand



### T20105 80W Pistol Grip Glue Gun

- Electric heating system
- Trigger feed mechanism controls glue flow
- High impact housing for durability
- Built-in stand



### T20108 12pc Glue Gun Sticks

- Size: 0.3" (7.4mm) x 4" (100mm)
- For T20102

### T20107 6pc Glue Gun Sticks

- Size: 7/16" (11.2mm) x 4" (100mm)
- For T20103, T20104, T20105





### T33918 Gas Soldering Tool

- Gas container capacity: 19ml
- Operating time: 90 minutes (80% w/ fuel)
- Approximate temperature: up to 480°C



### T33915 Gas Soldering Tool

- Portable rechargeable butane-powered soldering iron (manual ignition)



### T33920 Gas Soldering Tool

- Rechargeable butane-powered multi-function soldering iron / heat tool





### T33916 Multi-Function Soldering Iron & Flameless Heat Blower Set

- Contents:
  - 1 - Butane-Powered Soldering Iron
  - 1 - Flameless Heat Blower
  - 2 - Soldering Tip: 2.4mm Conical, 2.4mm Chisel
  - 1 - Soldering Wire: 60/40 Rosin Core Dia. Ø1.0mm, Weight 15g
  - 5 - Shrinking Tubes



### T33921 Multi-Function Soldering Tool Set

- Contents:
  - 1 - Cordless Butane-Powered Multi-function Soldering Iron / Heat Tool
  - 2 - Soldering Tip: 2.4mm Conical, 2.4mm Chisel
  - 5 - Hot Knife Tip, Heat Blower Tip, Deflector Tip, Sponge, Wrench
  - 1 - Soldering Wire: 60/40 Rosin Core Dia. Ø1.0mm, Weight 15g



### T33906 100W Pistol Grip Soldering Gun

- Excellent solution for a wide variety of soldering applications at the workshop or around the house
- Heats up in 6 to 8 seconds for immediate use
- Built-in pilot light illuminates work area
- Heavy duty storage case



### T33907 180W Pistol Grip Soldering Gun

- Industrial grade solution for a wide variety of soldering applications at the workshop or around the house
- Heats up in 3 to 5 seconds for immediate use
- Built-in pilot light illuminates work area
- Non-slip cushion grip
- Heavy duty storage case



### T33910 Solder Sucker

- High suction power
- Ideal for PC board repairing
- Lightweight
- Change tips simply by turning tips counterclock wise
- Clean cylinder occasionally



### Solder Wire



Model	Size
T33908	1mm x 3.5m
T33909	2mm x 1.75m



## Tube Bender

- Applies kink-free bends on tubing
- Bends aluminum, brass and copper
- Perfect for automotive, plumbing and refrigeration work



**T70742**

Capacity: Up to 1/4"



**T70743**

Up to 5/16"



**T70745**

Up to 1/2"

## T70748 Heavy Duty Tube Bender

- Heavy duty construction
- Four groove design fits popular tube sizes: 3/16", 1/4", 5/16", 3/8" O.D.



## T70750 Tube Bender

- Bends 3/16", 1/4", 5/16" and 3/8" diameter copper and steel tubes without kinking or collapsing
- Includes roller adaptors for each tube size for smooth bends



## T70741 Precision Tube Bender

- Heavy duty construction
- Use on tubing 1/4", 5/16", 3/8" O.D.
- Bends tubing to angles up to 90 degrees
- Marks for measurement from left to right ends of tube for precise bend angles



## Ez-Squeeze Tube Cutter

- Exclusive fastest functioning clamp
- Easy and swift adjustment of working size



**T70772**

8-22mm



**T70773**

8-28mm

## T70755 Tube Cutter

- Cuts tubes of 1/8" to 5/8" O.D.
- Mini-tube cutter works in especially tight conditions
- Makes accurate cuts



## T70756 Tube Cutter

- Cuts tubes of 1/8" to 1-1/8" O.D.
- SUJ-II blades for extra strength
- Makes accurate cuts







### T70760 Heavy Duty Tube Cutter

- Capacity: 3 - 35mm (1/8" - 1-3/8")
- Knob handle for smooth operation
- Four roller tracking system keeps tube from threading
- Full-stop feed system prevents wheels and rollers from coming into contact



### T70766 Tube Cutter

- Cuts up to 1/4" (6mm) from the end of tube
- Extra wide wheels keep cutter from spiralling
- Includes extra wheel under pivoting reamer blade
- Cuts tubing up to 1-1/8" (28.6mm) O.D.



### Ratcheting Tube Cutter

- Easily operates in narrow space with simple one-hand operation
- Cuts stainless steel, wall conduit, copper, aluminum

Model	Size
T70767	6 - 23mm
T70768	8 - 28mm
T70769	12 - 35mm

### T70774 Replacement Blades Set

- High carbon stainless steel with Molybdenum and Vanadium blades

T70774



### T75759 Double Flaring Tool and Tube Cutter (Metric)

- Double flares soft copper, aluminum and brass tubes
- Easy-to-use flaring bar works with 4.75mm, 5mm, 6mm, 1/4", 8mm, 10mm and 1/2" O.D. tubing
- Includes 7pc adaptors, pivoting reamer blade for tube end cleaning and extra cutting blade
- Tube cutter cuts from 1/8" to 1-1/8" O.D. tubes
- Blowcase for parts organization and convenient storage



### T14400 4m (13ft) Pipe Cleaner

- Fully flexible plated spring steel probe with turning handle
- Easily clears out washing machine hoses, kitchen drain pipes and all types of tubes



T14400



T14401

### T14401 7.5m (25ft) Drain And Trap Cleaner

- Flat spring steel "snake"
- Revolving coil spring point



# Lubrication Tools and Accessories





### T70301 Reversible 3-Jaw Oil Filter Wrench

- Easily removes spin-on type oil filters in confined spaces
- Serrated legs wrap around oil filter
- Capacity: 75-120mm (3" to 4-3/4")



### T70303 Universal 3-Jaw Filter Wrench

- 3-Jaw design completely adjustable to fit virtually any car or light truck
- Heat-treated carbon steel, black oxide finish
- Jaw capacity 63-99mm (2-1/2" to 3-7/8")



### T70306 Reversible 3-Jaw Oil Filter Wrench

- Special reversible jaw design to fit most cars and light trucks
- Chrome and black oxide finish
- Capacity: 64-102mm (2-1/2" to 4")



### T70308 Reversible Oil Filter Wrench

- Securely grips oil filters from 2-3/8" - 4"(60-100mm)
- Spring loaded reversible cam action design allows easy installation or removal of oil filters
- Use with a 3/8" Dr. wrench



### Swivel Handle Oil Filter Wrench

- 90-degree swivel to access filters in confined areas
- Blackened wide band resists corrosion and prevents the filter from being crushed
- Dimples on band and vinyl handle ensure a positive grip
- Ideal for removing most spin-on type oil filters



Model	Size
<b>T70310</b>	2-15/16" to 3-3/4"
<b>T70311</b>	4" to 4-3/8"
<b>T70317</b>	4-3/4" to 5-3/4"
<b>T70320</b>	2-7/8" to 3-1/4"
<b>T70321</b>	3-1/2" to 3-7/8"

### Heavy Duty Oil Filter Wrench

- Sturdy wide steel band with automatic clamping action
- Vinyl-coated handle for maximum torque and comfort
- Ideal for removing most spin-on type oil filters



Model	Fits Filters
<b>T70322</b>	2-7/8" to 3-1/8"
<b>T70323</b>	3-5/8" to 3-15/16"
<b>T70324</b>	2-1/4" to 2-3/4"





### T70326 Standard Oil Filter Wrench (3" to 3-3/4")

### T70328 Jumbo Oil Filter Wrench (4" to 4-3/8")

- Automatic clamping design
- Easy grip vinyl handle
- Ideal for removing most truck and tractor filters



### T70327 Jaw Grip Oil Filter Wrench

- Spring loaded for ease of use
- Short handle for maneuverability
- Fits filters: 2-3/4" to 4-1/4" (70-108mm)



### T70332 9" Oil Filter Pliers (60-90mm)

- Perfect for removing stubborn spin-on type oil filters
- Heavy duty laminated construction
- Serrated jaws with spring loaded adjustment
- Non-slip, cushion grip handles



### T70331 Oil Filter Pliers (60-115mm)

- Perfect for removing stubborn spin-on type oil filters
- Non-slip adjustable jaws with gripping teeth
- Non-slip, red vinyl handles



### T70333 10" Oil Filter Pliers (80-115mm)

- Perfect for removing larger spin-on oil type filters
- Heavy duty laminated construction
- Serrated jaws with spring loaded adjustment
- Non-slip, cushion grip handles



### T70423 Oil Filter Wrench Master Pliers

- Fits disposable car and truck filters with diameter of 2-1/8" to 4-5/8" (53-118mm)
- Non-slip, serrated jaws lock in position to remove stubborn oil filters
- Suitable for many other applications



### T70427 Strap Oil Filter Wrench

- Non-slip strap
- Universal application for automobiles, tractors and trucks



### T70426 Strap Oil Filter Wrench

- Extra large range fits most filters
- Four styles of non-slip straps
- Up to 6" diameter





### Chain Oil Filter Wrenches

- Chain style filter wrenches utilize a bicycle type chain for superb gripping action



T70417



T70418



T70425

### T70430 2pc Rubber Strap Wrench Set

- Durable, non-slip rubber strap for industrial strength and grip
- Flexible strap fits any shape & works easily in confined areas
- Versatile usage on automobiles, tractors, home applications and more
- 2-tone color handle w/ PVC coating for extra control



### T70424 Oil Filter Wrench

- Efficient space saving design allows access and operation in confined spaces
- Corrosion resistant, dimpled band adjusts easily via the knurled handle from 2-3/8" - 4.5" (60-110mm)



### T75871 14pc Cup Type Oil Filter Wrench Set

Includes:

T70401	74/76mm	15 flutes	2 step
T70402	76mm	14 flutes	1 step
T70403	93mm	15 flutes	1 step
T70404	73mm	14 flutes	1 step
T70405	65/67mm	14 flutes	2 step
T70406	68mm	14 flutes	1 step
T70407	80mm	15 flutes	1 step
T70409	90mm	15 flutes	1 step
T70410	80/82mm	15 flutes	2 step
T70411	93mm	36 flutes	1 step
T70412	75/77mm	15 flutes	2 step
T70413	65mm	14 flutes	1 step
T70414	76mm	30 flutes	1 step
T70415	100mm	15 flutes	1 step

and 1pcs adaptor - 1/2" Dr. (F) x 3/8" (M)

- Heat-treated, durable steel with black oxide finish to resist corrosion
- Specially designed for 1 or 2 step models, fitting various flute designs on Fram, AC, Casite, Lee, Hastings, Motorcraft, NAPA, Purolator, STP, Pure One, Wix, as well as some Japanese and European made filters
- Use with 3/8" Dr. ratchet
- Oil filter manufacturers reference table included



## T70416 Cup Type Oil Filter Wrench

- 88mm, 16 Flutes, 1 step
- Corrosion resistant, black oxide coated
- Designed specifically for Volvo Model S40, S70 & S80
- Use a 3/8" Dr. ratchet wrench for removal or installation



## T70420 Cup Type Oil Filter Wrench

- 64mm, 14 flutes, 1 step
- Corrosion resistant, black oxide coated
- Designed specifically for Toyota vehicles
- Use a 3/8" Dr. ratchet wrench for removal or installation



## T75872 3pc Oil Filter Cap Wrench Set

- Chrome Vanadium steel
- Use with 3/8" Dr. ratchet to remove and install oil filters for diesel engines

### Applications:

- 27mm - Mercedes Benz: aclass
- 32mm - Vauxhall/Opel : astra, corsa, zatira
- 36mm - Vauxhall/Opel : Omega di 16v, Vectra, BMW 16v,  
Ford : Mondeo 2.0d 16v dura torque engine,  
transit 2.5 & 2.0 dura torque diesel engine,  
Mercedes: 116mb engine vito cdi



## T75875 5pc Oil Filter Cap Wrench Set

- Chrome Vanadium steel
- Use with 3/8" Dr. ratchet to remove and install oil filters for diesel engines.

### Applications:

- 24mm - Cadillac 36
- 27mm - Mercedes Benz: aclass
- 32mm - Vauxhall/Opel: astra, corsa, zatira
- 36mm - Vauxhall/Opel: Omega di 16v, Vectra, BMW 16v,  
Ford : Mondeo 2.0d 16v dura torque engine,  
transit 2.5 & 2.0 dura torque diesel engine,  
Mercedes: 116mb engine vito cdi
- 38mm - Vauxhall/Vectra 2 L diesel engine







### Lever Type Grease Gun

- Chrome plated finish for long life
- Short stroke lever action for easy use
- Positive lock for easy filling
- Knurled thick wall barrel for secure grip
- Working pressure 4300 PSI

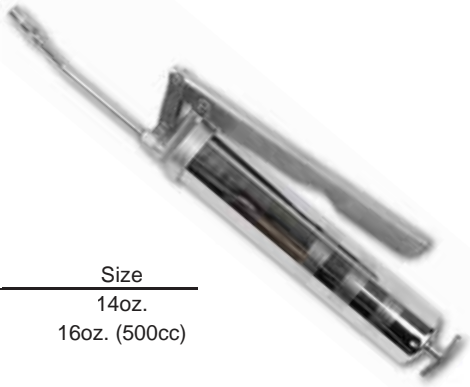

Model	Size
<b>T20016</b>	14oz.
<b>T20026</b>	16oz. (500cc)

### T20012 Lever Action Grease Gun

- Variable stroke lever action for easy use in tight places
- Heavy duty, die cast head, spring and handle for consistent priming
- 10,000 PSI maximum pressure
- 6" Extension pipe
- Uses standard 14oz. grease cartridges
- Loads 14oz. cartridge or bulk grease



### T20010 Pistol Grip Grease Gun

- Pistol grip action for easy one-handed operation
- Heavy duty die cast head, spring and handle for consistent priming
- 6,000 PSI maximum pressure
- Air bleeder valve eliminates air lock
- Loads 14oz. cartridge or bulk grease



### Mini Grease Gun

- Pistol grip action for easy one-handed operation
- 6,000 PSI maximum pressure
- Loads 3oz. grease cartridge



Model	Size
<b>T20013</b>	One-Way Mini Grease Gun
<b>T20014</b>	Two-Way Mini Grease Gun

### T20027 16oz. Pistol Grip Grease Gun (500cc)

- Pistol grip action for easy one-handed operation
- Heavy duty die cast head, spring and handle for consistent priming
- Air bleeder valve eliminates air lock
- Loads 16oz. cartridge or bulk grease



### T20011 Professional Grease Gun

- Variable stroke lever action for easy use in tight places
- Air bleeder valve eliminates air lock
- Heavy duty, die cast head, spring and handle for consistent priming
- 10,000 PSI maximum pressure
- 6" Extension pipe
- Loads 14oz. cartridge or bulk grease



**Heavy Duty Die Cast Head**





### T20015 Suction Gun

- Suitable for removals in transmissions, differentials, gear cases, lower units, crankcases, etc.
- Chrome plated, thick wall barrel, knurled for secure grip
- Zinc, die-cast head cap
- 12" Flexible suction hose
- 16oz. Capacity



### T20018 Suction Gun

- Perfect for transmissions, differentials, gear cases, lower units, crankcases, etc.
- Thick wall barrel construction, knurled for secure grip
- Cast aluminum T-handle
- Heavy duty die cast head cap
- 12" Flexible suction hose
- 14oz. Capacity



### T20017 Dual Transfer Pump

- No priming necessary
- Knurled thick wall barrel for secure grip
- Two-way vinyl hose for suction and discharge of fluids
- Durable check valve
- Heavy duty aluminum of container tube and plunger



### Flex Hose w/ Coupler

- For hand-operated grease guns only
- 1/8" NPT male thread double ends
- Working Pressure: 4,500PSI
- Burst Pressure: 12,000PSI



Model	Size
T20080	12" (305mm) Flex Hose w/ Coupler
T20081	18" (450mm) Flex Hose w/ Coupler

### T20020 Oiler Pistol Rigid (6oz.)

- Metal can with rigid spout and thumb operated lever action

### T20021 Oiler Pistol Flex (6oz.)

- Metal can with flexible spout and thumb operated lever action



T20020

T20021

### T20088 8pc Grease Fittings (SAE)

- 1/4" x 28 threads

### T20089 8pc Grease Fittings (Metric)

- 6mm x 28 threads
- Contents: 4pc straight, 2pc 45°, 2pc 90°





### T20085 4" Needle Nose Adaptor

- Dispenses a fine line of grease in hard-to-reach areas
- Use with hand grease guns only
- Excellent for farm equipment, 4WDs and recreational vehicles



### T20084 Grease Injector Needle

- Easily inserts under or through bearing seals
- Protective cover included
- Use with hand grease guns only



### T20098 360 Degree Grease Coupler

- 1/8" NPT female inlet
- Designed for cars, trucks and equipment with hard-to-reach fittings
- Great for front-wheel drive vehicles



### T20086 Grease Gun Coupler

- 1/8" NPT male thread
- Knurled body and mill flats for easy installation and removal
- Use with hand grease guns only



### T20087 Seal Off Dispenser

- Fits all standard grease gun hoses and extensions
- 1/8" NPT female thread
- Use with hand grease guns only



### Industrial Hose Reels

- Heavy duty steel construction for long life
- Use industrial and automotive applications
- Powder coated on drum, arm and bucket to prevent rust
- Wall, ceiling or floor mounted



Open Reel

Model	Inlet / Outlet		Max. Pressure (Psi/Bar)	Hose Capacity		Application
	(inch)			I.D. (inch)	Length (ft/m)	
<b>T21470</b>	3/8"		300 / 20	3/8"	50 / 15	Air, Water reel
<b>T21471</b>	1/2"		2000 / 138	1/2"	50 / 15	Oil reel
<b>T21472</b>	1/4"		5000 / 345	1/4"	50 / 15	Grease reel



Closed Reel

Model	Inlet / Outlet		Max. Pressure (Psi/Bar)	Hose Capacity		Application
	(inch)			I.D. (inch)	Length (ft/m)	
<b>T21475</b>	3/8"		300 / 20	3/8"	50 / 15	Air, Water reel
<b>T21476</b>	1/2"		2000 / 138	1/2"	50 / 15	Oil reel
<b>T21477</b>	1/4"		5000 / 345	1/4"	50 / 15	Grease reel





## Lever Action Drum Pumps



**T29400 Lever Action Drum Pump**

- Material: polypropylene and steel rod
- Application: water, alcohol, gasoline, diesel, kerosene, lubricant etc.
- 3.5 liter / 10 pumps



**T29401 Lever Action Drum Pump**

- Material: polypropylene, stainless steel rod
- Application: same as T29400, plus water based chemicals, acid and alkaline solutions
- 3.5 liter / 10 pumps



**T29402 Lever Action Drum Pump**

- Material: ryton and stainless steel rod, PTFE seal component
- Application: same as T29400, plus strong acid, strong alkaline solutions nitric acid etc.
- 3.5 liter / 10 pumps



**T29407 Plastic Rotary Pump**

- Suitable for aggressive chemicals
- Outlet can be freely adjusted from 0° to 360°
- Applicable liquids: acid, alkali, gasoline, diesel, machine oil, water, alcohol, thinner and other chemical liquids
- 20 liter / 72 rotations



**T29406 High Flow Pump**

- Versatile drum pump suitable for the transfer of low viscosity fluids such as gasoline, kerosene, diesel, machine oil, etc.
- Counterclockwise or clockwise for discharging or suctioning freely
- One liter per rotation and 100 liters per minute
- Vertical conveying distance 15m, horizontal conveying distance 50m
- 1 liter / 1 rotation





### T15100 Oil Drain Can

- Ideal for the recovery of oil and anti-freeze



### Portable Fuel Tanks

- Safety screw lock cap and flexible pouring spout



Model	Size
T15105	5 Liter
T15106	10 Liter

## Military & Outdoor Appliance

- Material: galvanized steel
- Accessory: Aluminum cap, Stored-inside spout, Aluminum venting screw

### Metal Safety Tank w/ Plastic Nozzle & Aluminum Cap

### Metal Safety Tank w/Plastic Nozzle & Aluminum Cap

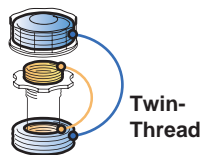

Twin-Thread

Vent Screw

Middle handle for one person  
Outside handles for two people

Vent Screw

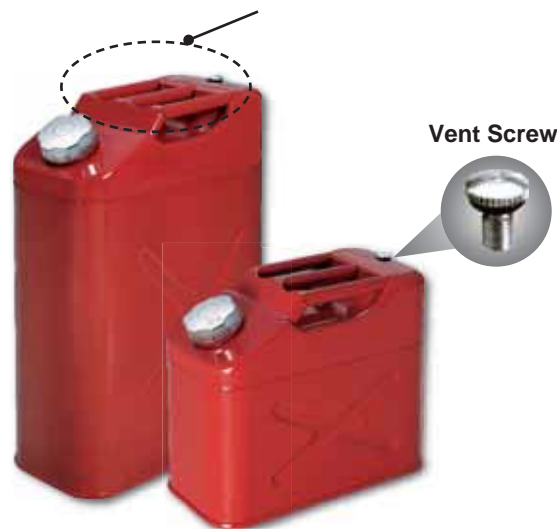

Model	Size
T15110	10 Liter
T15111	20 Liter

Model	Size
T15116	10 Liter
T15117	20 Liter





**Safety Wear**

**Peace of Mind**







### T25200 Safety Goggles

- Protects against flying particles from grinding, chipping and cutting operations
- Lightweight, soft frame mold
- High-impact, clear, polycarbonate lens
- Vertical and direct side vent provide maximum air flow
- Elastic band offers secure fit
- Meets CE EN 166B, ANSI Z87.1 and CSA Z94.3 standards



### T25202 Safety Goggles

- Protects against flying particles from grinding, chipping and cutting operations
- Lightweight, soft frame mold
- High-impact, clear, polycarbonate lens
- Vertical and direct side vent provide maximum air flow
- Elastic band offers secure fit
- Meets CE EN 166, ANSI Z87.1 and CSA Z94.3 standards



### T25201 Safety Eyewear

- Soft PVC frame
- High-impact, clear, polycarbonate lens
- 4 indirect vents on the bottom and top. Anti chemical and anti-impact
- Meets ANSI S3.19 and Csa Z94.3 standards



### T25203 Safety Eyewear

- Soft PVC frame
- High-impact, clear, polycarbonate lens
- Ergonomic shape with indirect ventilation for liquid splash protection
- Meets ANSI Z87.1 and Csa Z94.3 standards



### T25210 Safety Glasses

- One-piece lens provides maximum protection
- Scratch-resistant lens protects against UV radiation
- Direct side vents reduce heat buildup and fogging
- Meets CE EN 166 and ANSI Z87.1 standards



### T25212 Safety Goggles (Wide Angle)

- Durable, clear, polycarbonate wide-angle lens
- Indirect venting reduces fogging
- Elastic band offers secure fit
- Meets CE EN 166 and ANSI Z87.1 standards



### T25211 Safety Glasses

- Lightweight, durable polycarbonate lens
- Ratchet-action temples for adjustable fit
- Scratch-resistant lens protects against UV radiation
- Meets CE EN 166 and ANSI Z87.1 standards



### T73824 2pc Worker's Safety Set

- Flexible, soft fitting vinyl for great protection and comfort
- Mask vents to prevent fogging
- Dust mask filters dust and harmful airborne particles



### T25221 Welding Goggles (Lift Front)

- Soft, comfortable frame offers all round protection
- Indirect vents for positive ventilation
- Maximizes radiation protection while minimizing fogging of lenses
- Lift front design includes cover plate and impact plate
- Meets EN175 and ANSI Z87.1 standards



### T25220 Welding Goggles

- Soft, comfortable frame offers all round protection
- Indirect vents for positive ventilation
- Maximizes radiation protection while minimizing fogging of lenses
- Lift front design includes cover plate and impact plate
- Meets EN175 and ANSI Z87.1 standards



### T73825 Safety Goggles

- Flexible, soft fitting vinyl for great protection and comfort
- Mask vents to prevent fogging



### T25206 Welding Eye Mask (Lift Front)

- Soft PVC frame, ABS lens holder
- Six indirect vents in the frame for welding workplace
- Meets CE EN175 standards



### T20820 Welding Helmet

- Polypropylene impact resistant shell
- High strength nylon ratchet headgear
- Meets CE EN175 standards



### T20827 Welding Handshield

- Large, high impact resistant polypropylene shell for maximum coverage
- Inside handle for added protection
- Window size: 2" x 4-1/4"
- Meets EN 175 and ANSI Z87.1 standards





### T20824 Welding Helmet

- Combines the advantages of a full protection helmet and handle
- Window size: 2" x 4-1/4"



### T17701 Faceshield

- Meets CE EN166, CE EN 1731, ANSI Z87.1 standards



### T17700 Faceshield

- Nylon ratchet headgear with excellent working performance
- Meets CE EN166 standards



### T17705 Faceshield Headgear

- Nylon adjustable and insertion slot ratchet headgear
- Fit for 8" x 13-1/2" impact polycarbonate visor



### T17715 Faceshield Headgear (Metal Mesh)

- Metal mesh protects against splash, spray and flying particles
- Lightweight and comfortable
- Crown and faceshield assembly pivots up
- Meets CE EN 1731 standards



### T20802 Safety Helmet

- Safety helmet with high density polypropylene shell with vents
- Soft comfortable 4-point polyethylene harness with either slip or ratchet adjustment
- Meets CE EN397 and ANSI Z89.1 standards







### T20801 Safety Helmet

- Safety helmet with high density polypropylene shell
- Soft, comfortable, 4-point polyethylene harness with either slip or ratchet adjustment
- Meets ANSI Z89.1 standards



### T20800 Safety Helmet

- Safety helmet with high density polypropylene shell
- Soft, comfortable, 4-point polyethylene harness with either slip or ratchet adjustment
- Meets ANSI Z89.1 standards



### T20803 Hard Hat w/ Ratchet Suspension

- Equipped with browpads and 6-point ratchet suspension
- Trim profile with rain trough for protection against snow, rain and dirt
- Comfortable and snug fit for all-day wear
- Meets CE EN 397 and ANSI Z89.1 standards



### T17443 Disposable Ear Plugs

- Soft foam padded ear cushions for maximum comfort
- Bright colored ear plugs for high visibility
- Includes 40 disposable ear plugs
- Meets CE EN 352-2, SNR 36dB and ANSI S3.19, NRR 31dB



### T17440 Ear Band

- Handy and flexible PP neck string
- Comfortable sucker style silicone rubber plug



T17440



T17441

### T17441 Ear Band

- Innovative ear band design
- Adjustable sound-insulating ear plug
- Replaceable design



### T17400 Economy Earmuffs

- Adjustable head settings for proper fit
- Soft foam padded ear cushions for maximum comfort
- Meets CE EN 352-1, SNR 27dB and ANSI S3.19, NRR 14.71dB



### T17403 Earmuffs

- POM headband, ABS cup and soft PVC leather
- Adjustable slot on each side adjusts for a snug, comfortable fit
- 3-Position headband-head, neck or chin



### T17410 Compact Earmuffs

- Folds into compact size for minimal storage space
- Adjustable head settings for proper fit
- Soft foam padded ear cushions for maximum comfort
- Meets CE EN 352-1, SNR 30dB & ANSI S3.19, NRR 24.88dB standards



### T17411 Earmuffs

- Folds into compact size for minimal storage space
- Adjustable head settings for proper fit
- Soft foam padded ear cushions for maximum comfort
- Meets CE EN 352-1, SNR 30dB & ANSI S3.19, NRR 24.88dB standards



### T17420 Level Dependent Earmuffs

- Provides sound amplifying protection along with natural sound quality
- Adjustable stainless steel settings with padded head cushion
- Folds into compact size for minimal storage space
- Soft foam padded ear cushions for maximum comfort
- Requires 2 AA x 1.5V batteries (not included)
- Meets CE EN 352-1, SNR 27dB & ANSI S3.19, NRR 33dB standards



### T17423 Earmuffs

- Provides sound amplifying protection along with natural sound quality
- Includes FM stereo radio
- Separate volume and turning control
- Adjustable head settings for proper fit
- Folds into compact size for minimal storage
- Soft foam padded ear cushions for extra comfort
- Stainless steel headband with wide padded head cushion
- Requires 2 AA batteries (not included)
- Noise reduction rating: 30dB
- Meets EN352-1 & ANSI S3.19 standards



**T25021 Safety Respirator**

- Respirator with comfortable rubber facepiece
- ABS cartridge holder
- Reinforced adjustable elastic head strap
- Anti-particulate pre-filter

**T25024 Safety Respirator**

- Respirator with comfortable rubber filterable facepiece
- ABS cartridge holder
- Reinforced adjustable elastic head strap
- Anti-particulate pre-filter

**T25030 Anti-Dust Cartridge**

- Fits T25021 safety respirator
- Size: 70 x 34mm

**T25031 Anti-Organic Vapors Cartridge**

- Fits T25021 safety respirator
- Size: 70 x 34mm

**T25042 Anti-Paint Spray Cartridge**

- Fits T25024 safety respirator
- Size: 70 x 47mm

**T25040 Anti-Dust Cartridge**

- Fits T25024 safety respirator
- Size: 70 x 47mm

**T25041 Anti-Organic Vapors Cartridge**

- Fits T25024 safety respirator
- Size: 70 x 47mm

**T25043 Anti-Inorganic Vapors & Acid Gas Cartridge**

- Fits T25024 safety respirator
- Size: 70 x 47mm

**T25044 Anti-Acid Gas Cartridge**

- Fits T25024 safety respirator
- Size: 70 x 47mm

**T25045 Anti-Ammonia Cartridge**

- Fits T25024 safety respirator
- Size: 70 x 47mm







### T25000 Mask

- Comfortable PE frame design with changeable and washable polyester respirator
- Provides excellent filtration and low breathing resistance



### T25003 Mask

- Comfortable PE frame design with changeable and washable polyester respirator
- Provides excellent filtration and low breathing resistance



### T25011 Mask

- Polypropylene outer layer is very comfortable and fits the contours of the face
- Soft nose shape compatible with other PPE such as goggles or spectacles
- Suitable for protection against low toxic particulates



### T25013 Mask

- Polypropylene outer layer is very comfortable and fits the contours of the face
- Soft nose shape compatible with other PPE such as goggles or spectacles
- Suitable for protection against low toxic particulates



### T25014 Mask

- Polypropylene outer layer is very comfortable and fits the contours of the face
- Soft nose shape compatible with other PPE such as goggles or spectacles
- Suitable for protection against low toxic particulates



### T25015 Mask

- Polypropylene outer layer is very comfortable and fits the contours of the face
- Soft nose shape compatible with other PPE such as goggles or spectacles
- Suitable for protection against low toxic particulates



### T25006 Mask

- Protects against airborne particulates
- Suitable for dental procedures and other medical applications



### T25007 Mask

- Protects against airborne particulates
- Suitable for dental procedures and other medical applications



### T25010 Mask

- Soft nose shape design for snug fit
- Easy and steady to wear with glasses or safety goggles
- Reliable protection against air borne particulates
- Great for industrial and agricultural applications



### T25060 3pc Personal Safety Kit

- Contents:
  - 1 - Safety Masks
  - 1 - Ear Plugs (2pc/set)
  - 1 - Safety Goggles (PVC)



### T25061 7pc Personal Safety Kit

- Contents:
  - 3 - Safety Masks
  - 3 - Ear Plugs (2pc/set)
  - 1 - Safety Goggles (PVC)



### T25062 9pc Personal Safety Kit

- Contents:
  - 3 - Safety Masks
  - 3 - Ear Plugs (2pc/set)
  - 1 - Safety Goggles (PVC)
  - 1 - Safety Goggles (PC)
  - 1 - Working Gloves (2pc/set)





### Mechanic's Gloves

- Made of high-quality materials
- Flexible, durable synthetic palms for grip
- Spandex top for comfort, double-density fingers and thumb for added protection and a tailored elastic cuff for a firm, accurate fit



Model	Size
T20160	M
T20161	L
T20162	XL

Model	Size
T20163	M
T20164	L
T20165	XL



Magnetic Pad



Model	Size
T20166	M
T20167	L
T20168	XL

Model	Size
T20169	M
T20170	L
T20171	XL





# LED Flashlights





- T23975** USB Rechargeable 12-LED Flashlight (Red)
- T23976** USB Rechargeable 12-LED Flashlight (Blue)
- T23977** USB Rechargeable 12-LED Flashlight (Green)

- High performance, durable flashlight
- Compact, lightweight aluminum alloy construction
- 12 super bright 100,000-hour life LEDs
- 300mAH Ni-MH battery capacity
- Over 4 hours of continuous use
- Up to 15,000 peak beam candlepower, 14 lumens
- Use USB outlet to charge flashlight (USB - AC charger not included)



Charge by computer



### T23951 USB Rechargeable 12-LED Flashlight

- High performance, durable flashlight
- Compact, lightweight aluminum alloy construction
- 12 super bright 100,000-hour life LEDs
- 300mAH Ni-MH battery capacity
- Over 4 hours of continuous use
- Up to 15,000 peak beam candlepower, 14 lumens
- Includes AC and 12V Auto chargers



Charge by computer

24



12V Auto Charger



USB - AC Charger



Charge by AC Adaptor



Charge by Auto



## T24010 Rechargeable 14-LED Flashlight

- High performance, durable flashlight
- Compact, lightweight aluminum alloy construction
- 14 super bright 100,000-hour life LEDs
- 300mAH Ni-MH battery capacity
- Over 3 hours of continuous use
- Up to 15,000 peak beam candlepower, 45 lumens
- Includes a combo AC and USB Charger



Charge by Computer



USB - AC  
Charger



USB Cable



Charge by AC Adaptor

## T24011 Rechargeable 3-Watt LED Flashlight

- High performance, ultra bright flashlight
- Compact, lightweight aluminum alloy construction
- Lithium-ion 2200mAH battery capacity
- Over 15 hours of continuous use
- High intensity, ultra bright 3-watt 100,000-hour life LED, 120 lumens
- Includes a combo AC and USB Charger



USB - AC  
Charger



USB Cable



Pull to Extend for Charging





## T24012 Rechargeable 3-Watt Multi-Function LED Flashlight

Super-Bright  
3-Watt LED



- Versatile, high powered flashlight
- Compact, lightweight aluminum alloy construction
- Lithium-ion 2,200mAH battery capacity
- Over 24 hours of continuous use
- High intensity, ultra bright 3-watt 100,000-hour life LED, 123 lumens
- Three light intensity modes: 50%, 100% and strobe mode
- Includes a combo AC and USB Charger



Strobe Warning Light

Three Modes:  
50% Brightness,  
100% Brightness,  
Strobe



Pull to Extend for Charging



USB - AC  
Charger

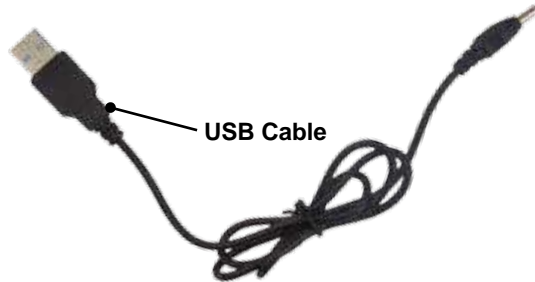

USB Cable



Charge by Computer

## T23929 12V Rechargeable 14-LED Auto Flashlight



- High performance, durable flashlight
- Compact, lightweight aluminum alloy construction
- 14 super bright 100,000-hour life LEDs
- Recharges in 12V DC socket
- 300mAH Ni-MH rechargeable battery
- Over 3 hours of continuous use
- Up to 15,000 peak beam candlepower, 45 lumens

On / Off



Auto Cigarette  
Lighter Inlet



## T19702 6-LED Flashlight with Magnetic Pickup

- 20" (500mm) Extendable retriever with flexible shaft
- Magnet lifts up to 3 lbs
- 6 super bright 100,000-hour life LEDs
- Over 8 hours of continuous use



4pc LR44  
Button-Cell  
Batteries Included 



Magnetic Tip



Pull and Release Head to Extend Pickup



Model	Color
<b>T23895</b>	Gray
<b>T23896</b>	Black
<b>T23897</b>	Red
<b>T23898</b>	Blue



Ultra Bright 6-LED Flashlight



Easily Access and Illuminate in Dark Confined Areas



### 6-LED Flashlight with Magnetic Pickup

- 20" (500mm) Extendable retriever with flexible shaft
- Magnet lifts up to 3 lbs
- 6 super bright 100,000-hour life LEDs
- Over 4 hours of continuous use



4pc LR44 Button-Cell Batteries Included 

Model	Color
<b>T19726</b>	Black
<b>T19727</b>	Red
<b>T19728</b>	Blue

Great for Graduation or Father's Day Promotions, Premiums or Special Presentations



### 5-LED Mini Flashlight with Magnetic Pickup

- 14-1/2" (265mm) Extendable retriever
- Magnet lifts up to 1 lb
- 5 super bright 100,000-hour life LEDs
- Over 5 hours of continuous uses

Model	Color
<b>T23890</b>	Black
<b>T23891</b>	Red
<b>T23892</b>	Blue
<b>T23893</b>	Gray



4pc LR44 Button-Cell Batteries Included 



### T19717 5-LED Mini Flashlight with Magnetic Pickup (8pc/Box)

- Packed with 8pc of red color flashlights in a display tray





## T23910 Heavy Duty Magnetic Pickup with 3-LED Flashlight

- Extends up to 27" (685mm)
- Strong, flexible shaft
- Heavy duty magnet lifts up to 10 lbs
- 3 super bright 100,000-hour life LEDs
- Over 6 hours of continuous use



4pc LR44  
Button-Cell  
Batteries Included 

## T23914 2-LED Mini Flashlight w/ Emergency Cell Phone Charger

- Compact, lightweight aluminum alloy construction
- 2 super bright 100,000-hour life LEDs
- Over 3 hours of continuous use
- Up to 15,000 peak beam candlepower, 7 lumens
- Emergency cell phone charger w/ 7 adaptors



1pc AA  
Battery Included 



- |                  |                          |
|------------------|--------------------------|
| 1. LG            | 5. Blackberry / Motorola |
| 2. Samsung       | 6. Nokia                 |
| 3. Sony Ericsson | 7. Nokia                 |
| 4. Macro USB     |                          |

- Contents:
  - 1 - 2-LED Mini Flashlight w/ Emergency Cell Phone Charger
  - 7 - Adaptors
  - 1 - AA Heavy Duty Energizer Battery





## T23956 5-LED Mini Flashlight and Screwdriver



Screwdriver Bits Stored in Handle



**Precision Bit Sizes:**  
Phillips: #0  
Slotted: 5/64" (2mm),  
1/8" (3mm)



4pc LR44 Button-Cell Batteries Included 



- Versatile, rugged flashlight / screwdriver combo
- Compact, lightweight aluminum alloy construction
- 5 super bright 100,000-hour life LEDs
- Combo batteries & bits pack stored in handle
- Over 2 hours of continuous use
- Up to 15,000 peak beam candlepower, 6 lumens
- Up to 10ft. beam range

## T23959 6-LED Flashlight and Screwdriver



Combo Pack Stores batteries & Screwdriver Bits



**Screwdriver Bit Sizes:**  
Phillips: #1, #2  
Slotted: 3/16" (5mm),  
1/4" (6mm)



3pc AAA Batteries Included 

- Versatile, rugged flashlight / screwdriver combo
- Compact, lightweight aluminum alloy construction
- 6 super bright 100,000-hour life LEDs
- Combo batteries & bits pack stored in handle
- Over 8 hours of continuous use
- Up to 15,000 peak beam candlepower, 15 lumens
- Up to 45ft. beam range

## T23997 1-LED Inspection Flashlight with Magnetic Pickup

Rotate Head to Turn Light On / Off

Pull to Extend Pickup

Push Button to Turn Light On / Off



4pc LR41 Button-Cell Batteries Included 

- Durable, aluminum alloy construction
- 1pc super bright 100,000-hour life white LED
- Over 2 hours of continuous use
- Up to 15,000 peak beam candlepower, 4 lumens
- Magnetic pickup lifts up to 1 lb
- Use with 4pc LR41 batteries

## T23921 8-LED Flashlight w/ Laser Pointer

- High performance, durable flashlight
- Compact, lightweight aluminum alloy construction
- High-range laser pointer encircled by super bright 8-LED flashlight for superior illumination
- Over 14 hours of continuous use
- Up to 15,000 peak beam candlepower, 15 lumens
- Up to 45ft. beam range, 300ft. w/ laser range

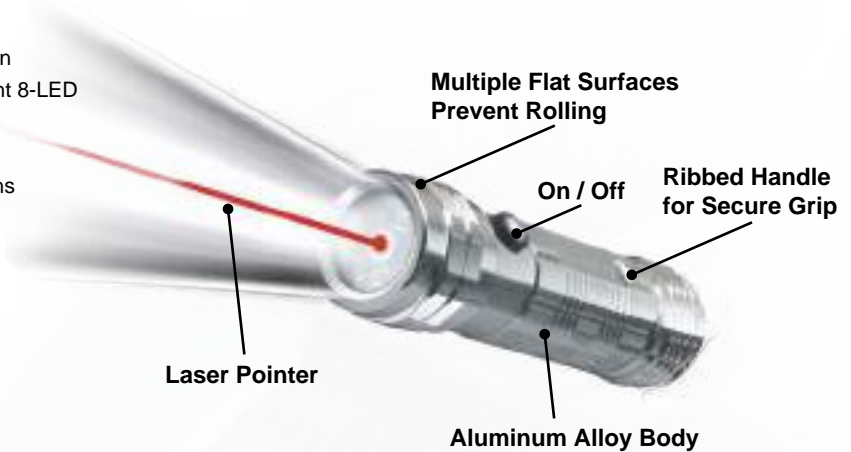

## T23968 9-LED Flashlight (8 White + 1 Green)

- High performance, durable flashlight
- Compact, lightweight aluminum alloy construction
- 8 super bright 100,000-hour life white LEDs
- Green LED cuts through mist and fog
- Over 14 hours of continuous use
- Up to 15,000 peak beam candlepower, 15 lumens
- Up to 45ft. beam range

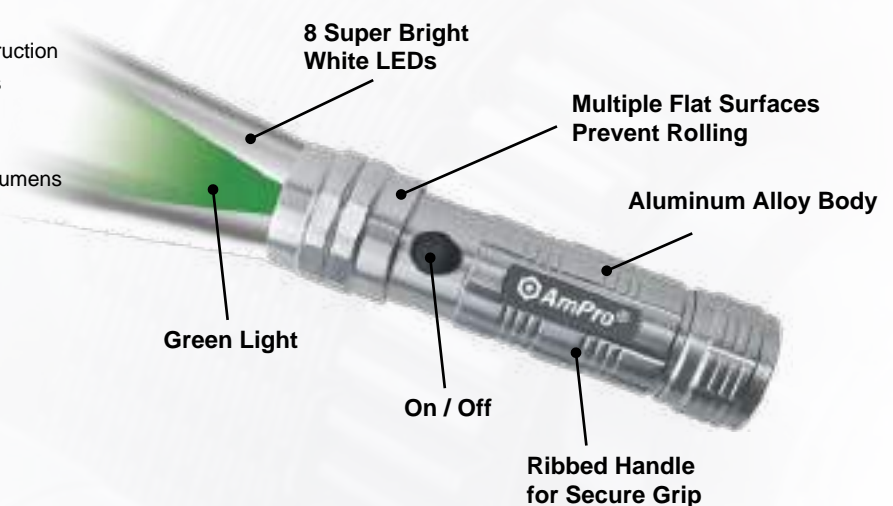

## T24000 2-in-1 Multi-Function LED Flashlight w/ Magnetic Base

- Versatile, high performance flashlight
- Compact, lightweight aluminum alloy construction
- Total 41 super bright 100,000-hour life LEDs
- 2 light modes: 17-LED flashlight, 24-LED work light
- Over 10 hours of continuous use
- Up to 15,000 peak beam candlepower, 18 lumens
- Up to 36ft. beam range



Attach magnetic base to a metal object for maintenance work





## T23985 2-in-1 Lantern / Flashlight

Flashlight Mode

Lantern Mode

Slide Handle to Switch from Flashlight to Lantern Mode

On / Off

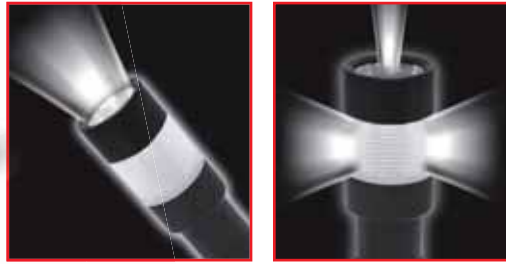

3pc AAA Batteries Included



## T23980 5 LED Clip-On Light

- 3 light modes: white, red, flash
- 5 extra bright LEDs
- Clip-on for hands-free illumination



2pc Extra CR 2032 Button-Cell Batteries Included



On / Off



## T23971 2-LED Head Lamp

- 2 light modes: white, flash
- Ultra bright LED
- Elastic head strap

1- Red LED



### To Replace Batteries:

1. Unscrew tailcap.
2. Replace with 3 new AAA batteries.

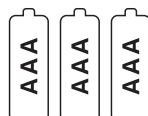

### 3-LED Light Modes:

1. Bright
2. Super Bright
3. 1-Red LED



3pc AAA Batteries Included



## Micro Miniture LED Flashlights

- Aluminum alloy construction
- Extra compact design
- Super bright 100,000-hour life LED
- Includes 4pc LR41 button cell batteries

**T23990 Red**

**T23991 Blue**

**T23992 Green**



## 12-LED Flashlight (9 White + 3 Color)

- Compact, lightweight aluminum alloy construction
- 12 super bright 100,000-hour life LEDs
- Color LEDs specially designed to serve a variety of applications

**T23993 Red LED - Enhances night vision**

**T23994 Blue LED - Shines through water and glass**

**T23995 Green LED - Cuts through mist and fog**



12-LED	45ft. Beam Distance	15 Lumens Output	14 Hours Battery Life
3pc AAA Batteries Included			



## T23996 1-LED Pen Style Flashlight

- Over 7 hours of continuous use
- Up to 15,000 peak beam candlepower, 4 lumens
- 1pc super bright 100,000-hour life LED
- Up to 14ft. beam range



1-LED	14ft. Beam Distance	4 Lumens Output	7 Hours Battery Life
-------	---------------------	-----------------	----------------------

## T23917 1-LED Pen Style Flashlight

- Over 50 hours of continuous use
- Up to 15,000 peak beam candlepower, 2 lumens
- Super bright 100,000-hour life LED
- Up to 13ft. beam range



1-LED	13ft. Beam Distance	2 Lumens Output	50 Hours Battery Life
-------	---------------------	-----------------	-----------------------

### T23913 3-LED Mini Flashlight

- High performance, durable flashlight
- Compact, lightweight aluminum alloy construction
- 3 super bright 100,000-hour life LEDs
- Over 6 hours of continuous use
- Up to 15,000 peak beam candlepower, 8 lumens
- Up to 13ft. beam range



1pc AA  
Battery Included





### T23919 3-LED Mini Flashlight

- High performance, durable flashlight
- Compact, lightweight aluminum alloy construction
- 3 super bright 100,000-hour life LEDs
- Over 5 hours of continuous use
- Up to 15,000 peak beam candlepower, 5 lumens
- Up to 13ft. beam range
- Includes key chain



4pc LR44  
Button-Cell  
Batteries Included





### T23909 6-LED Flashlight

- High performance, durable flashlight
- Compact, lightweight aluminum alloy construction
- 6 super bright 100,000-hour life LEDs
- Over 14 hours of continuous use
- Up to 15,000 peak beam candlepower, 19 lumens
- Up to 40ft. beam range



3pc AAA  
Batteries Included





## T23922 12-LED Flashlight

- High performance, durable flashlight
- Compact, lightweight aluminum alloy construction
- 12 super bright 100,000-hour life LEDs
- Over 15 hours of continuous use
- Up to 15,000 peak beam candlepower, 25 lumens
- Up to 50ft. beam range



## T23923 21-LED Flashlight

- High performance, durable flashlight
- Compact, lightweight aluminum alloy construction
- 21 super bright 100,000-hour life LEDs
- Over 13 hours of continuous use
- Up to 15,000 peak beam candlepower, 32 lumens
- Up to 50ft. beam range







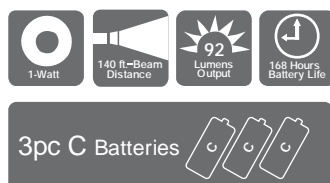



## T23967 Heavy Duty 1 Watt Flashlight

- Compact, professional grade, high performance flashlight
- Heavy duty aluminum alloy construction
- High intensity, ultra bright 1-watt 100,000-hour life LED, 92 lumens
- Over 168 hours of continuous use
- Up to 140ft. beam range
- Uses 3pc C-size batteries (Batteries not included)



## T23965 Heavy Duty 1 Watt & 38-LED Flashlight

- Professional grade, high performance flashlight
- Heavy duty aluminum alloy construction
- 1 Watt 100,000-hour life LED, 60 lumens
- 38-LED super bright 100,000-hour life LED, 40 lumens
- Uses 2pc D-size batteries (Batteries not included)





 1 Watt	 80ft. Beam Distance	 60 Lumens Output	 60 Hours Battery Life
 38-LED	 50ft. Beam Distance	 40 Lumens Output	 60 Hours Battery Life

2pc D Batteries 



## T23966 Heavy Duty 3 Watt Flashlight

- Full-size, professional grade, high performance flashlight
- Heavy duty aluminum alloy construction
- High intensity ultra bright 3-watt 100,000-hour life LED, 100 lumens
- Over 80 hours of continuous use
- Up to 145ft. beam range
- Uses 3pc D-size batteries (Batteries not included)

 3-Watt	 145ft. Beam Distance	 100 Lumens Output	 80 Hours Battery Life
---	--	---	---

3pc D Batteries 







# Garden Tools

Quality and Performance







### T58000 Dandelion Trowel

- Two-tone color, ergonomic handle
- Black epoxy finished blade



### T58001 Transplanter

- Two-tone color, ergonomic handle
- Black epoxy finished blade



### T58002 Transplanter

- Two-tone color, ergonomic handle
- Black epoxy finished blade



### T58003 Cultivator

- Two-tone color, ergonomic handle
- Black epoxy finished blade



### T58004 Weeder

- Two-tone color, ergonomic handle
- Black epoxy finished blade



### T58005 Spade Fork

- Two-tone color, ergonomic handle
- Black epoxy finished blade



### T58006 Spade Rake

- Two-tone color, ergonomic handle
- Black epoxy finished blade



### T58007 Garden Groove Cutter

- Two-tone color, ergonomic handle
- Black epoxy finished blade





### **T58200 19-1/4" (488mm) 15 Tines Adjustable Rake**

- Fifteen flexible round tines mounted in a heavy gauge pressed steel frame
- Zinc plated for corrosion protection
- Tubular steel handle with adjusting / locking lever and plastic grips
- Width: extends from 7" (175mm) to 22" (560mm)



### **T58201 48" (1220mm) 15 Tines Adjustable Rake**

- Fifteen flexible round tines mounted in a heavy gauge pressed steel frame
- Zinc plated for corrosion protection
- Tubular steel handle with adjusting/locking lever and plastic grips
- Width: Extends from 7" (175mm) to 22" (560mm)





### T58351 Anvil Pruner

- High carbon steel blade w/ non-stick coating
- Large safety switch is easy to work with one thumb
- Two-tone color PP w/ TPR handle



### T58352 Bypass Pruner

- High carbon steel blade w/ non-stick coating
- Large safety switch is easy to work with one thumb
- Two-tone color PP w/ TPR handle



### T58350 360-Degree Swivel Grass Shear

- Mid-carbon steel top blade w/ non-stick coating
- Mid-carbon steel bottom blade w/ black dyeing



### T58353 Piranha Grass Shears

- High carbon steel blade w/ non-stick coating
- Large safety switch is easy to work with one thumb
- Two-tone color PP w/ TPR handle



### T58430 26-1/2" Leverage Wavy Hedge Shears

- High carbon steel blade w/ non-stick coating
- Adjustable tension knob construction
- Two-tone color TPR handle



### T58431 22" Wavy Hedge Shears

- High carbon steel blade w/ non-stick coating
- Adjustable tension knob construction
- Two-tone color TPR handle







### T58400 Telescopic Bypass Lopper

- High carbon steel top blade and mid-carbon steel bottom blade
- Telescopic handles for adjustable lengths and multiple cutting positions



### T58401 Telescopic Bypass Lopper

- High carbon steel top blade and mid-carbon steel bottom blade
- Telescopic handles for adjustable lengths and multiple cutting positions
- Anti-slip stopper construction



1. Rotate handle grip counter-clockwise to loosen handle
2. Extend handle to desired length
3. Rotate the handle grip clockwise to fasten and make sure the handles are properly secured before application

### T58300 12pc Gardening Tool Set

- Contents:
  - 1 - Grass Shear: 336(L)mm
  - 1 - Bypass Pruner: 203(L)mm
  - 1 - Trimming Pruner: 216(L)mm
  - 1 - L Type Dibber: 337mm
  - 1 - Trowel: 270(L)mm
  - 1 - Spade-Rake: 305(L)mm
  - 1 - Weeding Knife w/ Double Blades: 194(L)mm
  - 1 - Weeder: 220(L)mm
  - 1 - 6 Teeth / 4 Position Wire Broom: 262~325mm
  - 1 - Plastic Sprayer: 280ml
  - 1 - Gloves w/ PVC Dot
  - 1 - Twist Tie Dispenser: 20m





### T58601 Metal Pulsating Sprinkler

- Large area sprinkler with full or part spray pattern
- Die cast metal head with brass tone finish



### T58604 Metal Impulse Sprinkler

- Large area sprinkler with full or part spray pattern
- Distance and density control
- Anti-backlash arm and screw diffuse adjustment
- Die cast metal head with brass tone finish



### T58602 Metal Spinning Fan Sprinkler

- Large area sprinkler with full or part spray pattern
- Die cast metal base



### T58603 Plastic 18-Hole Oscillating Sprinkler

- Brass jet spray construction
- Plastic base w/ heart arm



### T58860 4pc Brass Fitting Set

- Brass body construction



### T58800 4" Adjustable Nozzle

- Brass body construction





**T58822** Metal Brass Head Adjustable Trigger Nozzle w/ Adaptor



**T58820** Plastic Adjustable Trigger Nozzle w/ Adaptor



**T58824** Metal Adjustable Brass Head Front Trigger Nozzle w/ Adaptor



**T58821** Metal Trigger Nozzle w/ Protective Cap and Adaptor



**T58823** Metal 10-Pattern Front Trigger Nozzle w/ Adaptor



**T58840** Metal 9-Pattern Trigger Nozzle w/ Adaptor



**T58830** 18" Aluminum Shower Head Water Wand w/ Adaptor



**T58850** 5-1/2" Adjustable Brass Head Metal Trigger Hose Nozzle w/ Adaptor







**T58530 7.5m 3-Tube 5/8" Spray Hose**

**T58531 15m 3-Tube 5/8" Spray Hose**

- A flat shape hose with triple sprout
- Includes female tap adaptor and end cap



**T58500 15m PVC Garden Hose**

- Contents:
  - 1 - 1/2" x 15m Hose
  - 1 - Plastic 1/2" Hose Quick Connector
  - 1 - Plastic 1/2" Hose Quick Connector w/ Stop



# Air Compressors

## Air Tools & Accessories





### 1/2HP Mini Air Compressor

Model	A1644	A1645
Voltage	230 V	115 V
Frequency	50 Hz	60 Hz
Motor	0.75 KW	1/2 HP
Speed	1,750 rpm	1,750 rpm
Air Delivery	130 l/min	4.5 cfm at 50 PSI
Max. Pressure	3.5 bar	50 PSI
Certificate	CE	



### 1.0HP Direct Drive Air Compressor (6L, 2 Gallon)

Model	T81210	T81250
Voltage	230 V	115 V
Frequency	50 Hz	60 Hz
Motor	0.75 KW	1.5 HP
Speed	2,800 rpm	3,300 rpm
Tank	6 L	2 Gallon
Air Delivery	71 l/min at 40 PSI 51 l/min at 90 PSI	3.3 cfm at 40 PSI 2.4 cfm at 90 PSI
Max. Pressure	8 bar	115 PSI
Certificate	CE, GS, ENC, ROHS	CUL



### 2.5HP Direct Drive Air Compressor (25L, 6-1/2 Gallon)

Model	T81211	T81251
Voltage	230 V	115 V
Frequency	50 Hz	60 Hz
Motor	1.8 KW	2.5 HP
Speed	2,800 rpm	3,400 rpm
Tank	25 L	6.5 Gallon
Air Delivery	165 l/min at 40 PSI 125 l/min at 90 PSI	5.89 cfm at 40 PSI 4.6 cfm at 90 PSI
Max. Pressure	8 bar	115 PSI
Certificate	CE, GS, ENC, ROHS	CUS



### 3HP V-Type Direct Drive Air Compressor (50L, 13 Gallon)

Model	T81217	T81257
Voltage	230 V	115 V
Frequency	50 Hz	60 Hz
Motor	2.2 KW	3 HP
Speed	2,800 rpm	3,400 rpm
Tank	50 L	13 Gallon
Air Delivery	212 l/min to 40 PSI 184 l/min to 90 PSI	8.6 cfm to 40 PSI 7.6 cfm to 90 PSI
Max. Pressure	8 bar	115 PSI
Certificate	CE, GS, ENC, ROHS	ASME



## 2HP Belt Drive Air Compressor (32L, 8 Gallon)

Model	<b>T81220</b>	<b>T81260</b>
Voltage	230 V	115 V
Frequency	50 Hz	60 Hz
Motor	1.5 KW, 2 Pole Single Phase	2 HP, 2 Pole Single Phase
Speed	2,800 rpm	3,400 rpm
Tank	32 L	8.0 Gallon
Air Delivery	224 l/min at 40 PSI 180 l/min at 90 PSI	8.2 cfm at 40 PSI 6.6 cfm at 90 PSI
Max. Pressure	8 bar	115 PSI
Certificate	CE	ASME



## 3HP Belt Drive Air Compressor (50L, 13 Gallon)

Model	<b>T81222</b>	<b>T81262</b>
Voltage	230 V	115 V
Frequency	50 Hz	60 Hz
Motor	2.2 KW 2 Pole, Single Phase	3 HP 2 Pole, Single Phase
Speed	2,800 rpm	3,400 rpm
Tank	50 L	13 Gallon
Air Delivery	385 l/min at 40 PSI 320 l/min at 90 PSI	14.5 cfm at 40 PSI 12.3 cfm at 90 PSI
Max. Pressure	8 bar	115 PSI
Certificate	CE	ASME



## 3HP Belt Drive Air Compressor (50L, 13 Gallon)

Model	<b>T81221</b>	<b>T81261</b>
Voltage	230 V	115 V
Frequency	50 Hz	60 Hz
Motor	2.2 KW 2 Pole, Single Phase	3 HP, 2 Pole Single Phase
Speed	2,800 rpm	3,400 rpm
Tank	50 L	13 Gallon
Air Delivery	280 l/min at 40 PSI 220 l/min at 90 PSI	10.8 cfm at 40 PSI 8.0 cfm at 90 PSI
Max. Pressure	8 bar	115 PSI
Certificate	CE	ASME





### 5.5HP Belt Drive Air Compressor (32L, 8 Gallon)

Model	<b>T81230</b>	<b>T81270</b>
Displacement	163 ml	163 ml
Max. Power	4 KW / 3,600 rpm	4 KW / 3,600 rpm
Ignition System	CDI	CDI
Starting System	Manual	Manual
Recommended Power	3.4 KW / 3,600 rpm	3.4 KW / 3,600rpm
Rated Speed	3,600 rpm	3,600 rpm
Air Delivery	335 l/min at 40 PSI	12.5 cfm at 40 PSI
	250 l/min at 90 PSI	9.1 cfm at 90 PSI
Tank	32 L	8 Gallon
Max. Pressure	8 bar	115 PSI
Certificate	CE, EU	EPA, CARB, ASME



### 7.5HP Belt Drive Air Compressor (250L, 66 Gallon)

Model	<b>T81223</b>	<b>T81263</b>
Voltage	415 V	220 V
Frequency	50 Hz	60 Hz
Motor	5.5 KW	7.5 HP
	Three Phase	Three Phase
Speed	900 rpm	900 rpm
Tank	250 L	66 Gallon
Air Delivery	680 l/min at 40 PSI	24 cfm at 40 PSI
	566 l/min at 90 PSI	20 cfm at 90 PSI
Max. Pressure	8 bar	115 PSI
Certificate	CE	ASME



### 8.0HP Belt Drive Air Compressor (50L, 13 Gallon)

Model	<b>T81231</b>	<b>T81271</b>
Displacement	242 ml	242 ml
Max. Power	5.8 KW / 3,600 rpm	5.8KW / 3,600 rpm
Ignition System	CDI	CDI
Starting System	Manual	Manual
Recommended Power	5.1 KW / 3,600 rpm	5.1 KW / 3,600 rpm
Rated Speed	3,600 rpm	3,600rpm
Air Delivery	320 l/min at 40 PSI	22.5 cfm at 40 PSI
	250 l/min at 90 PSI	16.7 cfm at 90 PSI
Tank	50 L	13 Gallon
Max. Pressure	8 bar	115 PSI
Certificate	CE, EU	EPA, CARB, ASME

## 2.5HP Vertical Air Compressor (60L, 15 Gallon)

Model	<b>T81240</b>	<b>T81280</b>
Voltage	230 V	115 V
Frequency	50 Hz	60 Hz
Motor	1.8KW	2HP
Speed	2,800 rpm	3,300 rpm
Tank	60 L	15 Gallon
Air Delivery	170 l/min at 40 PSI	5.0 cfm at 40 PSI
	143 l/min at 90 PSI	4.0 cfm at 90 PSI
Max. Pressure	8.8 bar	125 PSI
Certificate	GS, CE, ENC, ROHS	CUL, ASME



## 5HP Belt Drive Vertical Air Compressor (100L, 27 Gallon)

Model	<b>T81241</b>	<b>T81281</b>
Voltage	230 V	115 V
Frequency	50 Hz	60 Hz
Motor	2.2 KW	3 HP
Speed	2,850 rpm	3,450 rpm
Tank	100 L	27 Gallon
Air Delivery	348 l/min at 40 PSI	13 cfm at 40 PSI
	260 l/min at 90 PSI	9.7 cfm at 90 PSI
Max. Pressure	8.8 bar	125 PSI
Certificate	CE	ASME



## 5.5HP Belt Drive Vertical Air Compressor (250L, 66 Gallon)

Model	<b>T81242</b>	<b>T81282</b>
Voltage	230 V	115 V
Frequency	50 Hz	60 Hz
Motor	4.0 KW	5.5 HP
Speed	2,850 rpm	3,450 rpm
Tank	250 L	66 Gallon
Air Delivery	410 l/min at 40 PSI	13.3 cfm at 40 PSI
	385 l/min at 90 PSI	11.6 cfm at 90 PSI
Max. Pressure	12.0 bar	165 PSI
Certificate	CE	ASME







### A4120 1/4" Dr. Professional Air Ratchet

- Compact head design for trim work, dash boards and smaller engines
- Reaches confined areas where impact wrenches can't reach
- Ball and needle bearing construction

Bolt Capacity	5/16" (8mm)
Free Speed	240 rpm
Max. Torque	18 ft/lb (24.4 N.m.)
Avg. Air Consumption	3 cfm (85 l/min)
Air Pressure	90 PSI
Air Inlet	1/4" NPT (PT)
Hose Size	3/8" ID



### A4128 3/8" Dr. Mini Air Ratchet

- 8-1/3" (212mm) Mini ratchet designed to fit into tight spaces
- Ball and needle bearing construction
- Rear exhaust outlet
- Composite handle reduces vibration

Bolt Capacity	3/8" (10mm)
Free Speed	160 rpm
Max. Torque	50 ft/lbs (67.8 N.m.)
Avg. Air Consumption	4.0 cfm (113 l/min)
Air Pressure	90 PSI
Air Inlet	1/4" NPT (PT)
Hose Size	3/8" ID



### A4142 1/2" Dr. Mini Air Ratchet

- 8-1/3" (220mm) Mini ratchet designed to fit into tight spaces
- Ideal tool for exhaust system and body shop repair work
- Ball retainer for positive socket retention
- Ball and needle bearing construction
- Composite handle reduces vibration

Bolt Capacity	1/2" (13mm)
Free Speed	160 rpm
Max. Torque	50 ft/lbs (67.8 N.m.)
Avg. Air Consumption	4.0 cfm (113 l/min)
Air Pressure	90 PSI
Air Inlet	1/4" NPT (PT)
Hose Size	3/8" ID



### A4131 3/8" Dr. Air Ratchet

- Ideal tool for exhaust system and body shop repair work
- Ball retainer for positive socket retention
- Ball and needle bearing construction
- Composite handle reduces vibration

Bolt Capacity	3/8" (10mm)
Free Speed	160 rpm
Max. Torque	50 ft/lbs (67.8 N.m.)
Avg. Air Consumption	4.0 cfm (113 l/min)
Air Pressure	90 PSI
Air Inlet	1/4" NPT (PT)
Hose Size	3/8" ID

## A4140 1/2" Dr. Air Ratchet

- Ideal tool for exhaust system and body shop repair work
- Ball retainer for positive socket retention
- Ball and needle bearing construction
- Composite handle reduces vibration

Bolt Capacity	1/2" (13mm)
Free Speed	160rpm
Max. Torque	50 ft/lbs (67.8 N.m.)
Avg. Air Consumption	4.0 cfm (113 l/min)
Air Pressure	90PSI
Air Inlet	1/4" NPT (PT)
Hose Size	3/8" ID



## A4144 1/2" Dr. High Torque Air Ratchet

- Heavy duty fiber composite body for performance and long life
- Composite handle reduces vibration
- Built-in swivel 360-degree exhaust design directs air away from work surface

Bolt Capacity	1/2" (13mm)
Free Speed	225 rpm
Max. Torque	100 ft/lbs (136 N.m.)
Avg. Air Consumption	4.0 cfm (113 l/min)
Air Pressure	90 PSI
Air Inlet	1/4" NPT (PT)
Hose Size	3/8" ID



## A4122 1/4" Dr. Stubby Air Ratchet

- 5" (120mm) Mini ratchet designed to fit into tight spaces
- Lever throttle for variable speed control
- Ball and needle bearing construction
- Rear exhaust outlet

Bolt Capacity	5/16" (8mm)
Free Speed	260 rpm
Max. Torque	20 ft/lbs (27 N.m.)
Avg. Air Consumption	3.0 cfm (85 l/min)
Air Pressure	90 PSI
Air Inlet	1/4" NPT (PT)
Hose Size	1/2" ID



## A4129 3/8" Dr. Stubby Air Ratchet

- 5" (120mm) Mini ratchet designed to fit into tight spaces
- Lever throttle for variable speed control
- Ball and needle bearing construction
- Rear exhaust outlet

Bolt Capacity	3/8" (10mm)
Free Speed	260 rpm
Max. Torque	20 ft/lbs (27 N.m.)
Avg. Air Consumption	3.0 cfm (85 l/min)
Air Pressure	90 PSI
Air Inlet	1/4" NPT (PT)
Hose Size	1/2" ID





(Bit not included)

### A4125 2-in-1 3/8" Dr. Stubby Air Ratchet & Bit Driver

- 5" (120mm) mini ratchet designed to fit into tight spaces
- Lever throttle for variable speed control
- Ball and needle bearing construction
- Rear exhaust outlet

Bolt Capacity	3/8" (10mm)
Free Speed	260 rpm
Max. Torque	20 ft/lbs (27 N.m.)
Avg. Air Consumption	3.0 cfm (85 l/min)
Air Pressure	90 PSI
Air Inlet	1/4" NPT (PT)
Hose Size	1/2" ID



### A4135 3/8" Dr. High Torque Air Ratchet

- Ideal tool for exhaust system
- Ball retainer for positive socket retention
- Ball and needle construction

Bolt Capacity	1-5/16" (33mm)
Free Speed	350 rpm
Max. Torque	74 ft/lbs (100 N.m.)
Avg. Air Consumption	8.825 cfm (250 l/min)
Air Pressure	90 PSI
Air Inlet	1/4" NPT (PT)
Hose Size	3/8" ID



### A4143 1/2" Dr. High Torque Air Ratchet

- Ideal tool for exhaust system
- Ball retainer for positive socket retention
- Ball and needle construction

Bolt Capacity	1-5/16" (33mm)
Free Speed	350 rpm
Max. Torque	74 ft/lbs (100 N.m.)
Avg. Air Consumption	8.825 cfm (250 l/min)
Air Pressure	90 PSI
Air Inlet	1/4" NPT (PT)
Hose Size	3/8" ID



## A3630 3/8" Dr. Butterfly Impact Wrench

- Ideal for small engine work in tight places
- Built-in regulator for complete speed control
- Air inlet swivels 360 degrees
- Single-handed forward and reverse power control

Bolt Capacity	7/16" (11mm)
Free Speed	10,000 rpm
Maximum Torque	75 ft/lbs (101.7 N.m.)
Avg. Air Consumption	4.0 cfm (113 l/min)
Recommended Air Pressure	90 PSI
Minimum Hose Size	3/8" ID



## A3638 3/8" Dr. Super Duty Impact Wrench

- Single hammer impact mechanism for removing and replacing bolts easily
- More torque, less vibration
- Pistol-grip design, compact and lightweight
- Built-in positive action regulator, handle exhaust

Bolt Capacity	7/16" (11mm)
Free Speed	10,000 rpm
Max. Torque	180 ft/lb (271 N.m.)
Avg. Air Consumption	2.5 cfm (70.8 l/min)
Air Pressure	90 PSI
Air Inlet	1/4" NPT (PT)
Hose Size	3/8" ID



## A3646 1/2" Dr. Lightweight Air Impact Wrench (Twin Hammer)

- Twin hammer mechanism for high torque performance
- Pistol grip design with non-slip sleeve in handle

Bolt Capacity	3/4" (19mm)
Free Speed	11,000 rpm
Max. Torque	400 ft/lbs (542 N.m.)
Avg. Air Consumption	3.0 cfm (85 l/min)
Air Pressure	90 PSI
Air Inlet	1/4" NPT (PT)
Hose Size	3/8" ID



## A3641 1/2" Dr. Air Impact Wrench (Rocking Dog)

- Ideal tool for general purpose tire and transmission assembly work
- Single-handed forward and reverse power control
- Durable rocking dog clutch design
- Built-in air regulator for positive speed and torque control
- Vinyl boot protects tool against damage

Bolt Capacity	5/8" (16mm)
Free Speed	7,000 rpm
Max. Torque	280 ft/lbs (380 N.m.)
Avg. Air Consumption	4.5 cfm (127 l/min)
Air Pressure	90 PSI
Air Inlet	1/4" NPT (PT)
Hose Size	3/8" ID





### A3649 1/2" Dr. Air Impact Wrench (Twin Hammer)

- Twin Hammer mechanism for high torque performance
- Super duty 1/2" impact wrench rated for industrial use
- Pistol grip design with non-slip sleeve in handle
- Rear exhaust directs air away from work surface

Bolt Capacity	3/4" (19mm)
Free speed	7,000 rpm
Max. Torque	460 ft/lbs (620 N.m.)
Avg. Air Consumption	6.0 cfm (170 l/min)
Air Pressure	90 PSI
Air Inlet	1/4" NPT (PT)
Hose Size	3/8" ID



### A3651 1/2" Dr. Air Impact Wrench (Twin Hammer)

- Twin Hammer mechanism for high torque performance
- Super duty 1/2" impact wrench rated for industrial use
- Pistol grip design with non-slip sleeve in handle
- Front exhaust outlet

Bolt Capacity	3/4" (19mm)
Free Speed	8,000 rpm
Max. Torque	460 ft/lbs (620 N.m.)
Avg. Air Consumption	4 cfm (113 l/min)
Air Pressure	90 PSI
Air Inlet	1/4" NPT (PT)
Hose Size	3/8" ID



### A3652 1/2" Dr. Extended Anvil Air Impact Wrench (Twin Hammer)

### A3655 1/2" Dr. Air Impact Wrench (Twin Hammer)

- Twin hammer mechanism for high power, speed, and durability
- Heavy duty to perform the toughest jobs with ease
- One-hand push button forward/reverse
- Adjustable power regulator
- Bottom exhaust directs air away from work area

Bolt Capacity	3/4" (19mm)
Free Speed	6,500 rpm
Max. Torque	600 ft/lbs (813.5 N.m.)
Avg. Air Consumption	4.4 cfm (125 l/min)
Air Pressure	90 PSI
Air Inlet	1/4" NPT (PT)
Hose Size	3/8" ID

## A3634 3/8" Dr. Lightweight Air Impact Wrench (Twin Hammer)

- Heavy duty fiber composite body for performance and long life
- Lightweight compact design
- Twin hammer mechanism for high torque performance
- Bottom exhaust directs air away from work surface

Bolt Capacity	1/2" (13mm)
Free Speed	10,000 rpm
Max. Torque	280 ft/lbs (380 N.m.)
Avg. Air Consumption	10.6 cfm (300 l/min)
Air Pressure	90 PSI
Air Inlet	1/4" NPT (PT)
Hose Size	3/8" ID



## A3639 1/2" Mini Air Impact Wrench (Twin Hammer)

- Heavy duty fiber composite body for performance and long life
- Lightweight compact design
- Twin hammer mechanism designed for high torque performance
- Bottom exhaust directs air away from work surface

Bolt Capacity	1/2" (13mm)
Free Speed	10,000 rpm
Max. Torque	320 ft/lbs (434 N.m.)
Avg. Air Consumption	10.6 cfm (300 l/min)
Air Pressure	90 PSI
Air Inlet	1/4" NPT (PT)
Hose Size	3/8" ID



## A3640 1/2" Dr. Air Impact Wrench (Twin Hammer)

- Heavy duty fiber composite body for performance and long life
- Lightweight compact design
- Twin hammer mechanism designed for high torque performance
- Bottom exhaust directs air away from work surface

Bolt Capacity	5/8" (16mm)
Free Speed	10,000 rpm
Max. Torque	1000 ft/lbs (1,356 N.m.)
Avg. Air Consumption	13 cfm (368 l/min)
Air Pressure	90 PSI
Air Inlet	1/4" NPT (PT)
Hose Size	3/8" ID







### A3659 3/4" Dr. Mini Air Impact Wrench (Twin Hammer)

- Heavy duty fiber composite body for performance and long life
- Lightweight design for added comfort
- Twin hammer mechanism design for high torque performance
- Bottom exhaust directs air away from work surface

Bolt Capacity	1" (26mm)
Free Speed	9,000 rpm
Max. Torque	1,000 ft/lbs (1,356 N.m.)
Avg. Air Consumption	13.7 cfm (388 l/min)
Air Pressure	90 PSI
Air Inlet	1/4" NPT (PT)
Hose Size	3/8" ID



### A3664 3/4" Dr. Air Impact Wrench (Twin Hammer)

- Durable twin hammer mechanism for engine teardowns and general maintenance
- High performance, lightweight and easy to operate
- Steel hammer case provides maximum protection
- Forward and reverse, adjustable torque control
- Front exhaust outlet

Bolt Capacity	1" (25mm)
Free Speed	6,500 rpm
Max. Torque	750 ft/lbs (1,016 N.m.)
Avg. Air Consumption	7.0 cfm (198 l/min)
Air Pressure	90PSI
Air Inlet	1/4" NPT (PT)
Hose Size	3/8" ID



### A3666 3/4" Dr. Heavy Duty Air Impact Wrench (Twin Hammer)

- Durable twin hammer mechanism for engine teardowns and general maintenance
- High performance, lightweight and easy to operate
- Steel hammer case provides maximum protection
- Forward and reverse, adjustable torque control
- Bottom exhaust directs air away from work surface

Bolt Capacity	1-1/4" (32mm)
Free Speed	4,000 rpm
Max. Torque	1,200 ft/lbs (1,627 N.m.)
Avg. Air Consumption	7.6 cfm (215 l/min)
Air Pressure	90 PSI
Air Inlet	1/4" NPT (PT)
Hose Size	3/8" ID

## A3670 3/4" Dr. Super Duty Air Impact Wrench (Twin Hammer)

- Durable twin hammer mechanism for engine teardowns and general maintenance
- High performance, lightweight and easy to operate
- Steel hammer case provides maximum protection
- Forward and reverse, adjustable torque control
- Bottom exhaust directs air away from work surface

Bolt Capacity	1-3/16" (30mm)
Free Speed	5,500 rpm
Max. Torque	1,100 ft/lbs (1,491 N.m.)
Avg. Air Consumption	9.5 cfm (269 l/min)
Air Pressure	90 PSI
Air Inlet	3/8" NPT (PT)
Hose Size	1/2" ID



## A3668 3/4" Dr. Heavy Duty Air Impact Wrench (Pin Clutch)

- Durable twin hammer mechanism for engine teardowns and general maintenance
- High performance, lightweight and easy to operate
- Steel hammer case provides maximum protection
- Forward and reverse, adjustable torque control
- Bottom exhaust directs air away from work surface

Bolt Capacity	1-1/4" (32mm)
Free Speed	4,000 rpm
Max. Torque	1,100 ft/lbs (1,493 N.m.)
Avg. Air Consumption	7.6 cfm (215 l/min)
Air Pressure	90 PSI
Air Inlet	1/4" NPT (PT)
Hose Size	3/8" ID



## A3675 1" Dr. Lightweight Air Impact Wrench (Pin Clutch)

- Compact and lightweight design provides durability and power for added performance
- Extended 6" anvil for hard-to-reach applications
- Handle exhaust directs air away from work surface
- Front exhaust outlet

Bolt Capacity	1-1/2" (38mm)
Free Speed	4,500 rpm
Max. Torque	1,300 ft/lbs (1,765 N.m.)
Avg. Air Consumption	14.5 cfm (411 l/min)
Air Pressure	90 PSI
Air Inlet	1/4" NPT (PT)
Hose Size	3/8" ID





### A3687 1" Dr. Super Duty Impact Wrench (Twin Hammer)

- Durable twin hammer impact mechanism
- Provides extra power without extra weight
- Exhaust outlet directs air away from operator for maximum safety
- Front exhaust outlet

Bolt Capacity	1-27/64" (36mm)
Free speed	4,000 rpm
Max. Torque	1,500 ft/lbs (2,033 N.m.)
Avg. Air Consumption	9.0 cfm (255 l/min)
Air Pressure	90 PSI
Air Inlet	1/2" NPT (PT)
Hose Size	3/4" ID



### A3676 1" Dr. Super Duty Impact Wrench (Twin Hammer)

- Durable twin hammer impact mechanism
- Provides extra power without extra weight
- Exhaust outlet directs air away from operator for maximum safety

Bolt Capacity	1-27/64" (36mm)
Free Speed	4,000 rpm
Max. Torque	1,500 ft/lbs (2,033 N.m.)
Avg. Air Consumption	9.0 cfm (255 l/min)
Air Pressure	90 PSI
Air Inlet	1/2" NPT (PT)
Hose Size	3/4" ID



### A3677 1" Dr. Super Duty Impact Wrench w/ 6" Anvil (Twin Hammer)

- Extended anvil wrench easily reaches into deep truck wheels
- Designed for high performance truck tire changing
- Handle exhaust directs air away from work surface
- Twin hammer impact mechanism

Bolt Capacity	1-27/64" (36mm)
Free Speed	4,000 rpm
Max. Torque	1,500 ft/lbs (2,033 N.m.)
Avg. Air Consumption	9.0 cfm (255 l/min)
Air Pressure	90 PSI
Air Inlet	1/2" NPT (PT)
Hose Size	3/4" ID



## A3678 1" Dr. Super Duty Impact Wrench w/ 6" Anvil (Twin Hammer)

- Durable twin hammer impact mechanism
- Side exhaust directs air away from work surface

Bolt Capacity	1-1/2" (38mm)
Free speed	4,000 rpm
Max. Torque	1,800 ft/lbs (2,440 N.m.)
Avg. Air Consumption	9.0 cfm (255 l/min)
Air Pressure	90 PSI
Air Inlet	1/2" NPT (PT)
Hose Size	3/4" ID



## A3682 1" Dr. Super Duty Impact Wrench

- Heavy duty twin hammer construction for greater power and durability
- Supported ring socket retainer
- Easy access reverse lever
- Ideal for heavy duty truck tire service work
- Bottom exhaust directs air away from work surface

Bolt Capacity	1-5/8" (41mm)
Free Speed	4,000 rpm
Max. Torque	1,800 ft/lbs (2440 N.m.)
Avg. Air Consumption	11 cfm (312 l/min)
Air Pressure	90 - 115 PSI
Air Inlet	1/2" NPT (PT)
Hose Size	1/2" ID



## A3681 1" Dr. Super Duty Impact Wrench w/ 8" Anvil

- Extended anvil wrench easily reaches into deep truck wheels
- Designed for high performance truck tire changing
- Bottom exhaust directs air away from work surface

Bolt Capacity	1-3/4" (45mm)
Free Speed	4,000 rpm
Max. Torque	1,800 ft/lbs (2,440 N.m.)
Avg. Air Consumption	12 cfm (340 l/min)
Air Pressure	90 - 115 PSI
Air Inlet	1/2" NPT (PT)
Hose Size	1/2" ID





### A3679 1" Dr. Super Duty Impact Wrench (Twin Hammer)

- Extended anvil wrench easily reaches into deep truck wheels
- Designed for high performance truck tire changing
- Handle exhaust directs air away from work surface

Bolt Capacity	1-1/2" (38mm)
Free Speed	4,000 rpm
Max. Torque	1,800 ft/lbs (2,440 N.m.)
Avg. Air Consumption	9.0 cfm (255 l/min)
Air Pressure	90 PSI
Air Inlet	1/2" NPT (PT)
Hose Size	3/4" ID



### A3685 1" Dr. Super Duty Impact Wrench (Twin Hammer)

- Twin hammer impact mechanism
- Provides extra power without extra weight
- Exhaust outlet directs air away from operator for maximum safety

Bolt Capacity	1-25/32" (45mm)
Free speed	3,000 rpm
Max. Torque	2,500 ft/lbs (3,388 N.m.)
Avg. Air Consumption	14.5 cfm (410 l/min)
Air Pressure	90 PSI
Air Inlet	1/2" NPT (PT)
Hose Size	3/4" ID



### A3686 1" Dr. Super Duty Impact Wrench w/8" Anvil (Twin Hammer)

- Extended anvil wrench easily reaches into deep truck wheels
- Designed for high performance truck tire changing
- Exhaust outlet directs air away from operator for maximum safety
- Twin hammer impact mechanism

Bolt Capacity	1-25/32" (45mm)
Free Speed	3,000 rpm
Max. Torque	2,500 ft/lbs (3,388 N.m.)
Avg. Air Consumption	14.5 cfm (410 l/min)
Air Pressure:	90 PSI
Air Inlet	1/2" NPT (PT)
Hose Size	3/4" ID



### A3691 1-1/2" Dr. Super Duty Impact Wrench (Twin Hammer)

- Provides extra power without extra weight
- Exhaust outlet directs air away from operator for maximum safety
- Twin hammer impact mechanism

Bolt Capacity	2" (50mm)
Free Speed	3,000 rpm
Max. Torque	3,000 ft/lbs (4,066 N.m.)
Avg. Air Consumption	16 cfm (453 l/min)
Air Pressure	90 PSI
Air Inlet	1/2" NPT (PT)
Hose Size	3/4" ID



### A3693 1-1/2" Dr. Super Duty Impact Wrench w/ 8" Anvil (Twin Hammer)

- Extended anvil wrench easily reaches into deep truck wheels
- Designed for high performance truck tire changing
- Exhaust outlet directs air away from operator for maximum safety
- Twin hammer impact mechanism

Bolt Capacity	2" (50mm)
Free Speed	3,000 rpm
Max. Torque	3,000 ft/lbs (4,066 N.m.)
Avg. Air Consumption	16 cfm (453 l/min)
Air Pressure	90 PSI
Air Inlet	1/2" NPT (PT)
Hose Size	3/4" ID







### A3014 Mini Air Angle Die Grinder

- Compact design with 90° angled head for easy access
- Capable of using carbide burrs and other attachments for polishing, porting and light metal removal
- Composite handle reduces vibration
- Lever throttle for feathering control

Collet Size	1/4" (6mm)
Free Speed	18,000 rpm
Avg. Air Consumption	3.0 cfm (85 l/min)
Air Pressure	90 PSI
Air Inlet	1/4" NPT (PT)
Hose Size	3/8" ID



### A3015 Air Angle Die Grinder

- Ideal for high speed grinding and polishing
- Finishes dies and metal molds, smooths and shapes sheet metal and cast iron, weld finishes and other high speed polishing applications
- Lever throttle for feathering control

Collet Size	1/4" (6mm)
Free Speed	18,000 rpm
Avg. Air Consumption	3.0 cfm (80 l/min)
Air Pressure	90 PSI
Air Inlet	1/4" NPT (PT)
Hose Size	3/8" ID



### A3017 Gearless Air Angle Die Grinder

- Heavy duty fiber composite body for performance and durability
- Unique gearless mechanism for longer tool life
- Accurately grinds, smooths and finishes
- Rear exhaust directs air away from work surface
- Lever throttle for feathering control

Collet Size	1/4" (6mm)
Free Speed	25,000 rpm
Avg. Air Consumption	4.5 cfm (127 l/min)
Air Pressure	90 PSI
Air Inlet	1/4" NPT (PT)
Hose Size	3/8" ID



### A3019 1HP Air Angle Die Grinder (Extreme Duty)

- Powerful, heavy duty 90° angle head construction
- Ideal for heavy welding, grinding, porting and polishing applications
- Lever throttle for feathering control
- Rear exhaust directs air away from work surface

Collet Size	1/4" (6mm)
Free Speed	12,000 rpm
Avg. Air Consumption	4.5 cfm (127 l/min)
Air Pressure	90 PSI
Air Inlet	1/4" NPT (PT)
Hose Size	3/8" ID

## A3016 Offset Air Angle Die Grinder

- 115-Degree offset design works in confined areas
- Finishes dies and metal molds, smooths and shapes sheet metal and cast iron, weld finishes and other high speed polishing applications
- Lever throttle for feathering control

Collet Size	1/4" (6mm)
Free Speed	18,000 rpm
Avg. Air Consumption	3.0 cfm (85 l/min)
Air Pressure	90 PSI
Air Inlet	1/4" NPT (PT)
Hose Size	3/8" ID



## A3028 Gearless Angle Head Die Grinder and 2" Angle Sander

- Accurately grinds, smooths and finishes rough areas when space is limited
- Perfect for touch-up and production sanding
- Unique gearless mechanism for longer tool life
- Rear exhaust directs air away from work surface

Collet Size	1/4" (6mm)
Free Speed	25,000 rpm
Avg. Air Consumption	4 - 6 cfm (170 l/min)
Air Pressure	90 PSI
Air Inlet	1/4" NPT (PT)
Hose Size	3/8" ID



## A3026 1/4" Mini Die Grinder

- Grinds, smooths and finishes rough areas when space is limited
- Ball bearing construction for longer tool life
- Rear exhaust directs air away from work surface
- Throttle lever enables positive speed control

Collet Size	1/4" (6mm)
Free Speed	25,000 rpm
Avg. Air Consumption	4.0 cfm (113 l/min)
Air Pressure	90 PSI
Air Inlet	1/4" NPT (PT)
Hose Size	3/8" ID



## A3020 Mini Air Die Grinder

- Ideal for light welding, grinding, porting and polishing applications
- High precision tool with spindle centricity less than 0.05mm
- Ergonomic cushioned grip handle
- Lever throttle for feathering control

Collet Size	1/4" (6mm)
Free Speed	25,000 rpm
Avg. Air Consumption	2.1 cfm (60 l/min)
Air Pressure	90 PSI
Air Inlet	1/4" NPT (PT)
Hose Size	3/8" ID





### A3033 Air Die Grinder

- Ideal for many automotive and industrial high speed grinding applications
- Cleans dies, rotors and brake pad mounts
- Can use with 1/4" (6mm) or 1/8" (3mm) grinding accessories
- Ergonomic cushioned grip
- Lever throttle for feathering control

Collet Size	1/4" (6mm)
Free Speed	22,000 rpm
Avg. Air Consumption	3.0 cfm (85 l/min)
Air Pressure	90 PSI
Air Inlet	1/4" NPT (PT)
Hose Size	3/8" ID



### A3034 Air Die Grinder (Industrial Grade)

- Ideal for heavy duty automotive and industrial high speed grinding applications
- Cleans dies, rotors and brake pad mounts
- Ergonomic cushioned grip

Collet Size	1/4" (6mm)
Free Speed	20,000 rpm
Avg. Air Consumption	9.8 cfm (280 l/min)
Air Pressure	90 PSI
Air Inlet	1/4" NPT (PT)
Hose Size	3/8" ID



### A3035 1HP Air Gearless Angle Die Grinder (Extreme Duty)

- Compact and lightweight
- Lever throttle for feathering control
- Rear exhaust directs air away from work surface

Collet Size	1/4" (6mm)
Free Speed	20,000 rpm
Avg. Air Consumption	4.5 cfm (127 l/min)
Air Pressure	90 PSI
Air Inlet	1/4" NPT (PT)
Hose Size	3/8" ID



### A3037 Extended Air Die Grinder

- High speed grinding and polishing in hard-to-reach areas
- Extended reach of 6"
- Use with 1/4" (6mm) or 1/8" (3mm) grinding accessories
- Ergonomic cushioned grip
- Lever throttle for feathering control

Collet Size	1/4" (6mm)
Free Speed	22,000 rpm
Avg. Air Consumption	3.0 cfm (85 l/min)
Air Pressure	90 PSI
Air Inlet	1/4" NPT (PT)
Hose Size	3/8" ID



### A3038 Extended Air Die Grinder (Extreme Duty)

- High speed grinding and polishing in hard-to-reach areas
- Ergonomic cushioned grip

Collet Size	1/4" (6mm)
Free Speed	30,000 rpm
Avg. Air Consumption	7.0 cfm (200 l/min)
Air Pressure	90 PSI
Air Inlet	1/4" NPT (PT)
Hose Size	3/8" ID

### A6313 Air Die Grinder Kit

- Cleans, deburs, blends and grinds metal fabrication, maintenance, production, and tool and die applications
- Includes five 1/4" and five 1/8" grinding stones, collet spanners, 1/8" collect insert and a plastic case
- Composite handle reduces vibration and insulates the operator from cold housing
- Ball bearing construction for long life
- Lever throttle for feathering control

Collet Size	1/4" (6mm), 1/8" (3mm)
Free Speed	22,000 rpm
Avg. Air Consumption	3.0 cfm (85 l/min)
Air Pressure	90 PSI
Air Inlet	1/4" NPT (PT)
Hose Size	3/8" ID

### A6314 Mini Air Angle Die Grinder Kit

- Grinds, deburs, polishes and smooths rough areas
- Ball bearing construction for advanced durability
- Rear exhaust directs air away from work surface
- Lever throttle for feathering control
- Includes an assortment of grinding stones, disc pad, extra collet and collet spanners

Collet Size	1/4" (6mm), 1/8" (3mm)
Free Speed	20,000 rpm
Avg. Air Consumption	2.1 cfm (60 l/min)
Backing Pad	3" (75mm)
Air Pressure	90 PSI
Air Inlet	1/4" NPT (PT)
Hose Size	3/8" ID

### A3001 Mini Air Micro Die Grinder

- Grinds, deburs, polishes and smooths rough areas
- Ideal for tight spots
- Designed for high speed porting and finishing of small parts

Collet Size	1/8" (3mm)
Free Speed	65,000 rpm
Avg. Air Consumption	2.65 cfm (75 l/min)
Air Pressure	90 PSI
Air Inlet	1/4" NPT (PT)
Hose Size	3/8" ID

### A3000 Mini Air Micro Die Grinder

- Collet Size: 3/32" (2.4mm)





### A3002 Precision Air Micro Die Grinder

- Grinds, deburs and smooths rough areas
- Ball bearing construction for advanced durability
- Rear exhaust directs air away from work surface
- Lightweight and easy to use
- Built-in silencer for quiet operation

Collet Size	1/8" (3mm)
Free Speed	54,000 rpm
Avg. Air Consumption	0.85 cfm (24 l/min)
Air Pressure	90 PSI
Air Inlet	1/4" NPT (PT)
Hose Size	3/8" ID



### A3003 Precision Air Micro Die Grinder

- 110° Angle head design
- Ideal for tight spots
- Designed for high speed porting and finishing of small parts
- Blow molded case for easy storage and transportation

Collet Size	1/8" (3mm)
Free Speed	70,000 rpm
Avg. Air Consumption	1.0 cfm (28.3 l/min)
Air Pressure	90 PSI
Air Inlet	1/4" NPT (PT)
Hose Size	3/8" ID



### A3039 Industrial Straight Air Grinder

- Heavy duty, double-row ball bearings ensure long life and smooth operation
- Self-locking throttle lever prevents accidental operation
- Rear exhaust directs air away from work surface

Grind Size	φ75 x φ9.5 x 13mm
Free Speed	13,500 rpm
Avg. Air Consumption	8.12 cfm (230 l/min)
Air Pressure	90 PSI
Air Inlet	1/4" NPT (PT)
Hose Size	3/8" ID



### A3070 7" Air Angle Grinder

- Ideal for both light and heavy duty applications
- Automatic throttle release
- Ball bearing balanced construction for vibration-free performance

Wheel Size	7" (175mm)
Spindle Thread	5/8" - 11 (M14)
Max Speed	7,000 rpm
Avg. Air Consumption	32.8 cfm (929 l/min)
Air Pressure	90 PSI
Air Inlet	3/8" NPT (PT)
Hose Size	1/2" ID

## Heavy Duty Air Grinder

- Lightweight and compact design
- Self-locking lever throttle prevents accidental start-ups
- Ideally suited to the automotive aftermarket and heavy duty industrial markets

**A3040**
**A3041**
**A3042**

Model	A3040	A3041	A3042
Wheel Size	4" (100mm)	4-1/2" (113mm)	5" (125mm)
Free Speed	11,000 rpm	11,000 rpm	11,000 rpm
Avg. Air Consumption	6.0 cfm (170 l/min)	6.0 cfm (170 l/min)	6.0 cfm (170 l/min)
Air Pressure	90 PSI	90 PSI	90 PSI
Air Inlet	1/4" NPT (PT)	1/4" NPT (PT)	1/4" NPT (PT)
Hose Size	3/8" ID	3/8" ID	3/8" ID

## A3075 7" Heavy Duty Vertical Air Grinder

- Double idler planetary gear system
- Ball bearing balanced construction for vibration-free performance
- Dual-handle design offers maximum operator control

Wheel Size	7" (175mm)
Spindle Thread	5/8" - 11
Free Speed	7,000 rpm
Avg. Air Consumption	36 cfm (1,019 l/min)
Air Pressure	90 PSI
Air Inlet	1/2" NPT (PT)
Hose Size	1/2" ID

\* Pad not included



## A3090 9" Heavy Duty Vertical Air Grinder

- Double idler planetary gear system
- Ball bearing construction for vibration-free performance
- Dual-handle design offers maximum operator control

Wheel Size	9" (225mm)
Spindle Thread	5/8" - 11
Free Speed	6,000 rpm
Avg. Air Consumption	36 cfm (1,019 l/min)
Air Pressure	90 PSI
Air Inlet	1/2" NPT (PT)
Hose Size	1/2" ID

\* Pad not included







### A4210 Delta Sander (Non-Vacuum)

- Compact design and comfortable grip
- Heavy duty construction for durable smooth operation
- Ideal for all types of surface sanding, polishing and scrubbing
- High powered, non-vacuum design

Orbital Stroke	1/8" (3.2mm)
Pad Size	100mm
Free Speed	10,000 rpm
Avg. Air Consumption	1.8 cfm (51 l/min)
Air Pressure	90 PSI
Air Inlet	1/4" NPT (PT)
Hose Size	3/8" ID
Noise Level	80 dBA



### A4211 Delta Sander (Central Vacuum)

- Compact design and comfortable grip
- Heavy duty construction for durable smooth operation
- Ideal for all types of surface sanding, polishing and scrubbing
- High powered, central vacuum design

Orbital Stroke	1/8" (3.2mm)
Pad Size	100mm
Free Speed	10,000 rpm
Avg. Air Consumption	1.8 cfm (51 l/min)
Air Pressure	90 PSI
Air Inlet	1/4" NPT (PT)
Hose Size	3/8" ID
Noise Level	80 dBA



### A4212 Delta Sander (Self-Vacuum)

- Compact design and comfortable grip
- Heavy duty construction for durable smooth operation
- Ideal for all types of surface sanding, polishing and scrubbing
- High powered, self-vacuum design

Orbital Stroke	1/8" (3.2mm)
Pad Size	100mm
Free Speed	10,000 rpm
Avg. Air Consumption	1.8 cfm (51 l/min)
Air Pressure	90 PSI
Air Inlet	1/4" NPT (PT)
Hose Size	3/8" ID
Noise Level	80 dBA



### A4244 Heavy Duty Jitterbug Sander (Central Vacuum)

- Smooth, reliable and powerful
- Long lasting durability with low maintenance
- For all types of surface preparation and rapid removal of material from large areas
- High powered, central vacuum design

Orbital Stroke	1/8" (3.2mm)
Pad Size	100 x 180mm
Free Speed	8,500 rpm
Avg. Air Consumption	1.65 cfm (47 l/min)
Air Pressure	90 PSI
Air Inlet	1/4" NPT (PT)
Hose Size	3/8" ID

### A4263 6" Palm Orbital Sander (Non-Vacuum)

- Lightweight and compact design for minimum operator fatigue
- Powerful and rapid removal of heavy materials, pre-paint preparation, feather edging and finish sanding
- Composite housing with palm grip
- High powered, non-vacuum design

Orbital Stroke	1/5" (5mm)
Pad Size	6" (150mm)
Free Speed	11,000 rpm
Avg. Air Consumption	1.5 cfm (42.5 l/min)
Air Pressure	90 PSI
Air Inlet	1/4" NPT (PT)
Hose Size	3/8" ID
Noise Level	80 dBA



### A4265 6" Palm Orbital Sander (Non-Vacuum)

- Orbital action ensures final swirl-free finish
- Lightweight, vibration-free performance
- Balanced ball bearing construction
- Contoured palm-grip handle for one-hand operation
- Variable speed throttle lever for positive speed control
- High powered, non-vacuum design

Orbital Stroke	1/5" (5mm)
Free Speed	9,000 - 10,000 rpm
Avg. Air Consumption	6.5 cfm (184 l/min)
Air Pressure	90 PSI
Pad Size	6" (150mm)
Air Inlet	1/4" NPT (PT)
Hose Size	3/8" ID
Noise Level	80 dBA



### A4264 6" Palm Orbital Sander (Self-Vacuum)

- Removes heavy material and body filler on large, flat surfaces leaving a swirl-free finish
- Vibration-free performance
- High powered, self-vacuum design

Orbital Stroke	1/5" (5mm)
Pad Size	6" (150mm)
Free Speed	11,000 rpm
Avg. Air Consumption	2.4 cfm (68 l/min)
Air Pressure	90 PSI
Air Inlet	1/4" NPT (PT)
Hose Size	3/8" ID
Noise Level	80 dBA





### A4266 6" Palm Orbital Sander (Central Vacuum)

- Removes heavy material and body filler on large, flat surfaces leaving a swirl-free finish
- Vibration-free performance
- High powered, central vacuum design

Orbital Stroke	1/5" (5mm)
Pad Size	6" (150mm)
Free Speed	11,000 rpm
Avg. Air Consumption	2.4 cfm (68 l/min)
Air Pressure	90 PSI
Air Inlet	1/4" NPT (PT)
Hose Size	3/8" ID
Noise Level	80 dBA



### A4269 6" Random Orbital Sander (Central Vacuum)

- Large orbit for removing heavy material with swirl-free finish
- Durable, lightweight, composite housing design
- High powered, central vacuum engineering

Orbital Stroke	3/8" (10mm)
Pad Size	6" (150mm)
Free Speed	9,000 rpm
Avg. Air Consumption	3.1 cfm (88 l/min)
Air Pressure	90 PSI
Air Inlet	1/4" NPT (PT)
Hose Size	3/8" ID
Noise Level	80 dBA



### A4261 6" Heavy Duty Orbital Sander

- Balanced ball bearing construction for vibration-free performance
- Automatic release throttle lever with positive action
- Built-in regulator for positive speed control

Pad Size	6" (150mm)
Spindle/Thread	5/16" - 24
Free Speed	10,000 rpm
Avg. Air Consumption	6.5 cfm (184 l/min)
Air Pressure	90 PSI
Air Inlet	1/4" NPT (PT)
Hose Size	3/8" ID



### A4224 3" Micro Air Orbital Sander

- Adjustable speed regulator to match speed to job
- Silenced exhaust directs air away from workspace
- 2 Finger throttle and comfortable rubber handle

Pad Size	3" (75mm)
Spindle/Thread	M6 * P1.0mm
Free Speed	15,000 rpm
Avg. Air Consumption	3.6 cfm (102 l/min)
Air Pressure	90 PSI
Air Inlet	1/4" NPT (PT)
Hose Size	3/8" ID



## A4243 Orbital "Jitterbug" Sander

- Heavy duty balanced ball bearing construction
- Automatic release throttle lever
- Locking abrasive clamp for positive sand paper retention
- Constant 3/16" stroke for a smooth, fine finish

Orbital Stroke	3/16" (5mm)
Pad Size	3-2/3" x 6-3/4" (92 x 171mm)
Free Speed	8,000 rpm
Avg. Air Consumption	4.0 cfm (113 l/min)
Air Pressure	90 PSI
Air Inlet	1/4" NPT (PT)
Hose Size	3/8" ID



## A4249 Heavy Duty Straight Line Air Sander

- Synchronized dual action pistons for balanced & smooth operation
- Long length pad for precise leveling
- Quick-action paper clamps
- Automatic release trigger with positive stop action

Pad Size	2-3/4" x 17-1/2" (70 x 455mm)
Stroke Length	1" (25mm)
Stroke per Min.	2,100 spm
Avg. Air Consumption	8.0 cfm (227 l/min)
Air Pressure	90 PSI
Air Inlet	1/4" NPT (PT)
Hose Size	3/8" ID



## A4270 7" Horizontal Air Angle Sander

- Built-in air regulator for positive speed adjustment
- Hardened and ground spiral bevelled gears for low vibration
- Side hand mounts on either side
- Lever throttle for positive speed control
- Excellent for heavy rust removal, metal sanding and shaping of contoured filler patches

Pad Size	7" (175mm)
Spindle / Thread Size	5/8" - 11
Free Speed	4,500 rpm
Avg. Air Consumption	12.0 cfm (340 l/min)
Air Pressure	90 PSI
Air Inlet	1/4" NPT (PT)
Hose Size	3/8" ID



## A4271 7" Air Heavy Duty Angle Sander

- Ideal for both light and heavy duty applications
- Automatic throttle release
- Ball bearing construction for long life

Wheel Size	7" (175mm)
Spindle Thread	5/8" - 11
Free Speed	4,500 rpm
Avg. Air Consumption	19.7 cfm (558 l/min)
Air Pressure	90 PSI
Air Inlet	3/8" NPT (PT)
Hose Size	3/8" ID





### A4231 Wet Air Sander (3" or 4" Pad)

- Angle of polish: 12° - 20°
- Grinder pressure: 1 - 3 kg/c
- Lever throttle for feathering control
- Sufficient water supply is required

Spindle Thread	5/8" - 11(M14)
Max. Speed	5,000 rpm
Avg. Air Consumption	8.2 cfm (232 l/min)
Air Pressure	90 PSI
Air Inlet	1/4" NPT (PT)
Hose Size	3/8" ID



### A4252 Air High Speed Sander

- Deluxe smooth handle for comfortable operation
- Excellent for a variety of surface conditioning operations such as paint removal, light touch-up work, rust removal, etc.

Grinding Wheel	5" (125mm)
Free Speed	16,000 rpm
Avg. Air Consumption	5.0 cfm (142 l/min)
Air Pressure	90 PSI
Air Inlet	1/4" NPT (PT)
Hose Size	3/8" ID



### A4291 Heavy Duty Air Belt Sander

- Ideal for finishing different shapes of surfaces
- Lightweight balanced tool to make fine finishing
- Lever throttle for positive speed control
- Rear exhaust directs air away from work surface

Size of Belt	10 * 330mm
Free Speed	16,000 rpm
Avg. Air Consumption	8.0 cfm (227 l/min))
Air Pressure	90 PSI
Air Inlet	1/4" NPT (PT)
Hose Size	3/8" ID



### A4292 Heavy Duty Air Belt Sander

- Ideal for irregular angles/shapes on car bodywork
- Rear exhaust directs air away from work surface
- Cushioned grip for added control and comfort

Size of Belt	20 * 520mm
Free Speed	16,000 rpm
Avg. Air Consumption	9.0 cfm (255 l/min)
Air Pressure	90 PSI
Air Inlet	1/4" NPT (PT)
Hose Size	3/8" ID



### A4071 7" Heavy Duty Horizontal Air Angle Polisher

- Ideal for heavy duty buffering
- Side hand mounts on either side

Wheel Size	7" (175mm)
Spindle Thread	5/8" - 11
Free Speed	2,500 rpm
Avg. Air Consumption	19.7 cfm (558 l/min)
Air Pressure	90 PSI
Air Inlet	1/4" NPT (PT)
Hose Size	1/2" ID



### A4065 3" Micro Air Polisher

- Adjustable speed regulator to match speed to job
- Silenced exhaust directs air away from workspace
- 2 Finger throttle and comfortable rubber handle

Pad Size	3" (75mm)
Spindle/Thread	M6 * P1.0mm
Free Speed	2,500 rpm
Avg. Air Consumption	3.6 cfm (102 l/min)
Air Pressure	90 PSI
Air Inlet	1/4" NPT (PT)
Hose Size	3/8" ID







### Adjustable Clutch Air Screwdriver

- Straight type
- Hanger handle
- Lightweight body
- Quick change bit retainer
- Rear exhaustion & low noise design



**A4401**

**A4400**

	A4401	A4400
Bolt Size Capacity	3 - 4mm	4.0mm
5s Torque Increase	2.3 ft/lbs (3.0 N.m.)	2.3 ft/lbs (3.0 N.m.)
Free Speed	1,250 rpm	1,700 rpm
Avg. Air Consumption	2.0 cfm ( 57 l/min)	2.0 cfm ( 57 l/min)
Air Pressure	90 PSI	90 PSI
Air Inlet	1/4" NPT (PT)	1/4" NPT (PT)
Hose Size	1/4" ID	1/4" ID

### Adjustable Clutch Air Screwdriver

- 90° Angle head design
- Hanger handle
- Lightweight body
- Quick change bit retainer
- Rear exhaustion & low noise design



**A4410**

**A4411**

	A4410	A4411
Bolt Size Capacity	5 - 6mm	3 - 4mm
5s Torque Increase	3.7 ft/lbs (5.0 N.m.)	2.3 ft/lbs (3.0 N.m.)
Free Speed	1,650 rpm	1,250 rpm
Avg. Air Consumption	3.0 cfm (85 l/min)	2.0 cfm (57 l/min)
Air Pressure	90 PSI	90 PSI
Air Inlet	1/4" NPT (PT)	1/4" NPT (PT)
Hose Size	1/4" ID	1/4" ID

### A4408 Adjustable Clutch Air Screwdriver

- Straight type
- External adjustable clutch mechanism
- Lightweight body
- Quick change bit retainer
- Rear exhaustion & low noise design



Square Drive	1/8 - 13/64" (3 - 5mm)
Min. Torque	1.8 ft/lbs (2.5 N.m.)
Max. Torque	5.9 ft/lbs (8 N.m.)
Free Speed	1,800 rpm
Avg. Air Consumption	4.42 cfm (125 l/min)
Air Pressure	90 PSI
Air Inlet	1/4" NPT (PT)
Hose Size	1/4" ID

## A4427 Pistol Grip Adjustable Clutch Air Screwdriver

- Pistol grip design
- External adjustable clutch mechanism
- Quick change bit retainer

Square Drive	1/8 - 13/64" (3 - 5mm)
Min. Torque	1.8 ft/lbs (2.5 N.m.)
Max. Torque	6.6 ft/lbs (9 N.m.)
Free Speed	1,800 rpm
Avg. Air Consumption	4.42 cfm (125 l/min)
Air Pressure	90 PSI
Air Inlet	1/4" NPT (PT)
Hose Size	1/4" ID



## A4455 Impact Air Screwdriver (Twin Hammer)

- Twin hammer and high frequent impact mechanism for removing and replacing screws easily
- Rear exhaust & low noise engineering

Bolt Size Capacity	8 - 9mm
5s Increase Torque	185 ft/lbs (250 N.m.)
Free Speed	5,500 rpm
Avg. Air Consumption	4.42 cfm (57 l/min)
Air Pressure	90 PSI
Air Inlet	1/4" NPT (PT)
Hose Size	1/4" ID



## A4456 Impact Air Screwdriver (Twin Hammer)

- Twin hammer and high frequent impact mechanism for removing and replacing screws easily
- Rear exhaust & low noise engineering

Bolt Size Capacity	4 - 6mm
5s Torque Increase	15 ft/lbs (20 N.m.)
Free Speed	9,000 rpm
Avg. Air Consumption	2.0 cfm (57 l/min)
Air Pressure	90 PSI
Air Inlet	1/4" NPT (PT)
Hose Size	1/4" ID



## A4476 Pistol Grip Air Screwdriver

- Non-pin design for high torque and low counteraction
- Rear exhaust directs air away from work surface
- Pistol grip design with non-slip rubber handle

Bolt Size Capacity	4 - 6mm
5s Torque Increase	15 ft/lbs (20 N.m.)
Free Speed	9,000 rpm
Avg. Air Consumption	2.0 cfm (57 l/min)
Air Pressure	90 PSI
Air Inlet	1/4" NPT (PT)
Hose Size	1/4" ID





### A2439 3/8" Straight Drill w/ Keyless Chuck

- In-line drill designed for low speed/high torque applications, such as drilling, sanding and polishing
- Quick-lock, keyless chuck for easy replacement
- Level throttle for positive speed control
- Cushioned grip

Drill Capacity	3/8" (10mm)
Spindle/Thread Size	3/8" - 24
Free Speed	2,600 rpm
Avg. Air Consumption	3.0 cfm (85 l/min)
Air Pressure	90 PSI
Air Inlet	1/4" NPT (PT)
Hose Size	3/8" ID



### A2425 1/4" Mini Reversible Air Drill w/ Keyless Chuck

- Ideal for heavy duty drilling, engine work and other auto body applications
- Handle exhaust directs air away from work surface
- Pistol grip design with non-slip rubber handle
- Keyless chuck construction for easy drill replacement

Drill Capacity	3/8" (10mm)
Spindle/Thread Size	3/8" - 24
Free Speed	2,800 rpm
Avg. Air Consumption	4.0 cfm (113 l/min)
Air Pressure	90 PSI
Air Inlet	1/4" NPT (PT)
Hose Size	3/8" ID



### A2428 3/8" Reversible Air Drill w/ keyless Chuck

- Ideal for heavy duty drilling, engine work and other auto body applications
- Handle exhaust directs air away from work surface
- Positive action trigger for variable speed control
- Keyless chuck construction for easy drill replacement

Drill Capacity	3/8" (10mm)
Spindle/Thread Size	3/8" - 24
Free Speed	2,000 rpm
Avg. Air Consumption	4.0 cfm (113 l/min)
Air Pressure	90 PSI
Air Inlet	1/4" NPT (PT)
Hose Size	3/8" ID



### A2443 1/2" Reversible Air Drill w/ keyless Chuck

- Ideal for heavy duty drilling, engine work and other auto body applications
- Handle exhaust directs air away from work surface
- Positive action trigger for variable speed control
- Side handle for extra control and comfort
- Keyless chuck construction for easy drill replacement

Drill Capacity	1/2" (13mm)
Spindle/Thread Size	1/2" - 20
Free Speed	450 rpm
Avg. Air Consumption	4.0 cfm (113 l/min)
Air Pressure	90 PSI
Air Inlet	1/4" NPT (PT)
Hose Size	3/8" ID



## A2432 3/8" Air Angle Head Drill

- Compact design for easy access
- Lever throttle for positive speed control
- Rear exhaust keeps air away from work area
- Forward/Reverse control locks in both positions
- Lightweight for fatigue-free handling

Drill Capacity	3/8" (10mm)
Free Speed	1,800 rpm
Avg. Air Consumption	4.0 cfm (113 l/min)
Air Pressure	90 PSI
Air Inlet	1/4" NPT (PT)
Hose Size	3/8" ID



## A2451 Industrial Air Spot Drill

- Adjustable depth stop which allows you to drill out just the spot weld and not the panel beneath
- Drills out the entire spot weld, eliminating the need for grinding
- Pistol grip design with non-slip rubber handle

Drill Capacity	5/16" (8mm)
Spindle/Thread Size	3/8" - 24
Free Speed	1,800 rpm
Avg. Air Consumption	5.0 cfm (142 l/min)
Air Pressure	90 PSI
Air Inlet	1/4" NPT (PT)
Hose Size	3/8" ID



## A2452 Industrial Air Spot Drill

- Adjustable depth stop which allows you to drill out just the spot weld and not the panel beneath
- Drills out the entire spot weld, eliminating the need for grinding
- Pistol grip design with non-slip rubber handle

Drill Capacity	5/16" (8mm)
Spindle/Thread Size	3/8" - 24
Free Speed	1,600 rpm
Avg. Air Consumption	6.0 cfm (170 l/min)
Air Pressure	90 PSI
Air Inlet	1/4" NPT (PT)
Hose Size	3/8" ID



## A3130 Palm Grip Air Hammer w/ 6 Tips

- Ideal for small engine work in tight places
- Ergonomic arc design
- Rubber head reduces friction on surface for smooth operation

Bore Size	1-7/16" (37mm)
Blow per Min.	1,000 bpm
Stroke Length	1/5" (5mm)
Avg. Air Consumption	4.0 cfm (113 l/min)
Air Pressure	30 - 125 PSI
Air Inlet	1/4" NPT (PT)
Hose Size	3/8" ID





### A3101 Professional Air Hammer w/ 5 Chisels

- Includes five industrial grade chisels
- Ideal for cutting applications, exhaust systems and general repair work
- Quick change spring retainer for added safety

Bore Size	3/4" (19mm)
Chisel Shank	3/8" (10mm)
Blow per Min.	3,200 bpm
Stroke Length	2-5/8" (66mm)
Avg. Air Consumption	4.0 cfm (113 l/min)
Air Pressure	90 PSI
Air Inlet	1/4" NPT (PT)
Hose Size	3/8" ID



### A3112 190mm Heavy Duty Air Hammer

- Ideal for cutting applications, exhaust systems and general repair work
- Heat-treated piston and cylinder for durability
- Trigger control for speed and power
- Quick change spring retainer for added safety
- Pistol grip design with non-slip rubber handle

Bore Size	3/4" (19mm)
Chisel Shank	10.3mm
Blow per Min.	3,200 bpm
Stroke Length	2-5/8" (66mm)
Avg. Air Consumption	3.7 cfm (105 l/min)
Air Pressure	90 PSI
Air Inlet	1/4" NPT (PT)
Hose Size	3/8" ID



### A3104 250mm Heavy Duty Air Hammer

- Ideal for cutting applications, exhaust systems and general repair work
- Heat-treated piston and cylinder for durability
- Trigger control for speed and power
- Quick change spring retainer for added safety
- Pistol grip design with non-slip rubber handle

Bore Size	3/4" (19mm)
Chisel Shank	10.3mm
Blow Per Min.	2,100 bpm
Stroke Length	3-5/8" (89mm)
Avg. Air Consumption	3.3 cfm (93 l/min)
Air Pressure	90 PSI
Air Inlet	1/4" NPT (PT)
Hose Size	3/8" ID

## A3121 Industrial Air Riveting Hammer

- Powerful air hammer provides hard hitting blows required to drive 1/8" to 1/4" steel rivets used in industrial assembly applications
- Ideal for a wide variety of heavier hammering, chipping, cutting and scraping applications
- Pistol grip design with non-slip rubber handle

Bore Size	3/4" (19mm)
Chisel Shank	12.7mm
Blow per Min.	2,200 bpm
Stroke Length	2-11/16" (68mm)
Avg. Air Consumption	7.0 cfm (198 l/min)
Air Pressure	90 PSI
Air Inlet	1/4" NPT (PT)
Hose Size	3/8" ID



## A3155 Mini Air Chipping Hammer (Hex Type)

- Powerful hard hitting industrial chipping hammers
- Offers the perfect balance of service life and performance
- Outside teasing throttle
- Drop forged, open handle design
- Heat treated, hardened steel piston and cylinder for long life

Bore Size	11.8mm
Chisel Length	220mm
Blow per Min.	3,600 bpm
Stroke Length	2-5/8" (66mm)
Avg. Air Consumption	4.0 cfm (113 l/min)
Air Pressure	90 PSI
Air Inlet	1/4" NPT (PT)
Hose Size	3/8" ID



## Industrial Air Chipping Hammers (Hex Type)

- Powerful hard hitting industrial chipping hammers
- Offers the perfect balance of service life and performance
- Outside teasing throttle
- Drop forged, open handle design
- Heat treated, hardened steel piston and cylinder for long life



	A3156	A3157	A3158	A3159
Bore Size	14.5mm	14.5mm	14.5mm	14.5mm
Chisel Length	250mm	250mm	250mm	250mm
Blow per Min.	2,500 bpm	2,300 bpm	2,000 bpm	1,600 bpm
Stroke Length	1" (25mm)	2" (50mm)	3" (76mm)	4" (100mm)
Avg. Air Consumption	10 cfm (283 l/min)	20 cfm (566 l/min)	22 cfm (623 l/min)	24 cfm (680 l/min)
Air Pressure	90 PSI	90 PSI	90 PSI	90 PSI
Air Inlet	3/8" NPT (PT)	3/8" NPT (PT)	3/8" NPT (PT)	3/8" NPT (PT)
Hose Size	1/2" ID	1/2" ID	1/2" ID	1/2" ID





### A4302 Single Piston Air Scaler w/ Handle

- Removes rust, paint and cement from steel
- Piston scalers can be used in confined areas

Piston Dia.	30 x 24 x 75mm
Blow per Min.	8,000 bpm
Stroke Length	15/16" (24mm)
Avg. Air Consumption	8.5 cfm (241 l/min)
Air Pressure	90 PSI
Air Inlet	1/4" NPT (PT)
Hose Size	3/8" ID



### A4301 Triple Piston Air Scaler

- Removes rust, paint and cement from steel
- Piston scalers can be used in areas that A4302 scalers can't fit

Piston Dia.	27 x 21 x 69mm
Blow per Min.	3,000 bpm
Stroke Length	7/8" (22.5mm)
Avg. Air Consumption	11.5 cfm (326 l/min)
Air Pressure	90 PSI
Air Inlet	1/4" NPT (PT)
Hose Size	3/8" ID



### A4312 Industrial Air Flux Chisel

- Ideal for scaling rust removal
- Comes complete with flux chisel

Piston Dia.	11 x 25 x 50mm
Blow per Min.	4,000 bpm
Stroke Length	7/8" (22.5mm)
Avg. Air Consumption	11.4 cfm (323 l/min)
Air Pressure	90 PSI
Air Inlet	1/4" NPT (PT)
Hose Size	3/8" ID



### A4314 Industrial Air Flux Scaler w/ Chisel & Needle

- Ideal for scaling rust removal
- Includes needle scaler attachment with high tension steel needles
- Comes complete with flux chisel

Piston Dia.	11 x 25 x 50mm
Blow per Min.	4,000 bpm
Stroke Length	7/8" (22.5mm)
Avg. Air Consumption	11.4 cfm (323 l/min)
Air Pressure	90 PSI
Air Inlet	1/4" NPT (PT)
Hose Size	3/8" ID

## A4316 Industrial Air Flux Chisel

- Powerful, heavy duty industrial flux chipper
- Lightweight, compact design allows maximum operator control and access to jobs in hard-to-reach areas
- Lever throttle control
- Easy to use ball type chisel retainer allows for quick, easy bit changes
- Converts into needle scaler
- Ideal for chipping operations including removal of slag, scale, welds and masonry

Piston Dia.	22 x 19 x 59mm
Blow per Min.	4,000 bpm
Stroke Length	1-5/16" (33mm)
Avg. Air Consumption	8.8 cfm (249 l/min)
Air Pressure	90 PSI
Air Inlet	1/4" NPT (PT)
Hose Size	3/8" ID



## A4313 Industrial Air Flux Scaler

- Powerful hammer suitable for a wide variety of applications
- Powerful motor and easy to control throttle

Piston Dia.	11 x 25 x 50mm
Blow per Min.	4,000 bpm
Stroke Length	7/8" (22.5mm)
Avg. Air Consumption	11.4 cfm (323 l/min)
Air Pressure	90 PSI
Air Inlet	1/4" NPT (PT)
Number of Needles	Ø3 x 19pc
Hose Size	3/8" ID



## A4315 Heavy Duty Straight Air Needle Scaler

- Powerful, heavy duty industrial needle scaler
- Lightweight design
- Lever throttle control
- Excellent for paint, rust, dirt or weld scale removal from irregular and curved surfaces or hard-to-access areas

Piston Dia.	20 x 17 x 47mm
Blow per Min.	4,000 bpm
Stroke Length	1-1/16" (27mm)
Avg. Air Consumption	8.8 cfm (249 l/min)
Air Pressure	90 PSI
Air Inlet	1/4" NPT (PT)
Number of Needles	Ø3 x 12pc
Hose Size	3/8" ID



## A4321 Pistol Grip Air Needle Scaler

- Powerful hammer suitable for a wide variety of applications
- Powerful motor and easy to control throttle
- Pistol grip design with non-slip rubber covered handle

Piston Dia.	23.5 x 20 x 73 (mm)
Blow per Min.	3,700 bpm
Air Consumption	10 cfm (283 l/min)
Air Pressure	90 PSI
Air Inlet	1/4" NPT (PT)
Numbers of Needles	Ø2 x 29pc, Ø3 x 19pc
Hose Size	3/8" ID





### A2308 Air Nibbler

- Lever throttle for positive speed control
- Cuts metal and plastic sheets
- Cuts up to 16 gauge mild steel
- Adjustable die guide for forward, backward, right or left cutting
- Ergonomic cushioned grip

Max. Cutting	16 gauge (1.2mm)
Stroke per Min.	2,600 spm
Avg. Air Consumption	3.0 cfm (85 l/min)
Air Pressure	90 PSI
Air Inlet	1/4" NPT (PT)
Hose Size	3/8" ID



### A2307 Heavy Duty Air Nibbler

- Lever throttle for positive speed control
- Cuts metal and plastic sheets
- Cutting capacity up to 18 gauge mild steel
- Adjustable die guide for forward, backward, right or left cutting

Max. Cutting Capacity	16 gauge (1.2mm)
Stroke per Min.	2,100 rpm
Avg. Air Consumption	4.0 cfm (113 l/min)
Air Pressure	90 PSI
Air Inlet	1/4" NPT (PT)
Hose Size	3/8" ID



### A2303 Utility Air Cut-Off Tool

- 3" Cutter is ideal for a wide range of cutting applications
- Ergonomic cushioned grip
- Lever throttle for feathering control

Max. Cutting Capacity	3/4" (19mm)
Wheel Dia.	3" (75mm)
Free Speed	21,000 rpm
Avg. Air Consumption	3.0 cfm (85 l/min)
Air Pressure	90 PSI
Air Inlet	1/4" NPT (PT)
Hose Size	3/8" ID



### A2311 Professional Air Body Saw

- Ideal for body shop repair, muffler and exhaust work
- Cuts all types of aluminum, plastic, fiberglass and sheet metal
- Cuts intricate shapes and tight radial curves

Max. Cutting Size	16 gauge (1.2mm)
Stroke Length	10mm
Stroke per Min.	9,000 bpm
Avg. Air Consumption	4.0 cfm (113 l/min)
Air Pressure	90 PSI
Air Inlet	1/4" NPT (PT)
Hose Size	3/8" ID



## A2319 2-in-1 Air Saw & File w/ Hose

- 2-in-1 Function designed
- Cuts all types of aluminum, plastic, fiberglass, and sheet metal
- Cuts intricate shapes and tight radial curves
- Cushioned grip for added control and comfort

Max. Cutting Size	14 gauge (1.6mm)
Stroke Length	10mm
Stroke per Min.	5,000 bpm
Avg. Air Consumption	4.0 cfm (113 l/min)
Air Pressure	90 PSI
Air Inlet	1/4" NPT (PT)
Hose Size	3/8" ID



## A2305 Air Knife w/ Blade

- As a sealant cutter, cuts around bonded and encapsulated glass
- Cleans and smooths moldings after glass removal
- Teasing throttle and regulator provide easy speed control
- Flexible blade mount can be positioned in 12 different ways (at 30° increments)
- Rear exhaust directs air away from work surface

Blow per Min.	20,000 rpm
Avg. Air Consumption	7.0 cfm (198 l/min)
Air Pressure	90 PSI
Air Inlet	1/4" NPT (PT)
Hose Size	3/8" ID



## A2321 Pistol Grip Air Metal Shear

- Ideal for cutting, trimming and shearing tin, plastic, aluminum and other metals up to 18 gauge
- Universal cutter for all applications such as various sheet metal fabricating, cutting vehicle body panels and other cutting needs
- Variable cutting speed control for precision work and use in close quarters

Max. Capacity Size	16 gauge (1.2mm)
Free Speed	2,200 rpm
Avg. Air Consumption	6.5 cfm (184 l/min)
Air Pressure	90 PSI
Air Inlet	1/4" NPT (PT)
Hose Size	3/8" ID



## A3750 Air Shear

- Durable construction delivers long hours of cutting power
- Lightweight and easy to operate
- Unique safety lock accidental start-up
- Forged blades for easy cuts

Air Consumption	8 - 10 bar
Cutting Power	0 - 25 m/m
Working Pressure	2.8 cfm (80 l/min)
Air Pressure	90 PSI
Air Inlet	1/4" NPT (PT)
Hose Size	3/8" ID





### A2304 Heavy Duty Air File

- Heavy duty construction for strength and durability
- Excellent for light deburring and finishing work

Stroke Length	5/16" (8mm)
Free Speed	3,700 rpm
Avg. Air Consumption	6.0 cfm (170 l/min)
Air Pressure	90 PSI
Air Inlet	1/4" NPT (PT)
Hose Size	3/8" ID



### A2325 Heavy Duty Air File

- Heavy duty construction for strength and durability
- Excellent for light deburring and finishing work

Blows per Min.	2,500 bpm
Stroke Length	1.2mm
Avg. Air Consumption	3.5 cfm (100 l/min)
Air Pressure	90 PSI
Air Inlet	1/4" NPT (PT)
Hose Size	3/8" ID



### A2302 Air Punch & Flange Tool

- Performs hole punching and panel crimping
- Rotating head for convenient use
- Every pull of the lever delivers a single punch or a single flange crimp with precision control
- Forms an offset crimped edge on sheet metals for no-bump lap welds
- Cuts metal fabrication time in half

Capacity	14 gauge (1.6mm)
Punch	5mm
Flange Width	12mm
Avg. Air Consumption	4.0 cfm (113 l/min)
Air Pressure	90 PSI
Air Inlet	1/4" NPT (PT)
Hose Size	3/8" ID



### A2309 Pistol Grip Air Punch & Flange Tool

- Performs hole punching and panel crimping
- Rotating head for convenient use
- Every pull of the lever delivers a single punch or a single flange crimp with precision control
- Forms an offset crimped edge on sheet metals for no-bump lap welds
- Pistol grip design with non-slip rubber handle

Capacity	14 gauge (1.6mm)
Punch	5.5mm
Flange Width	12mm
Avg. Air Consumption	4.0 cfm (113 l/min)
Air Pressure	90 PSI
Air Inlet	1/4" NPT (PT)
Hose Size	3/8" ID

### A3706 3/16" Hydraulic Air Riveter

- Ideal for aluminium and steel rivets up to 3/16"
- Supplied with four riveting nozzles and two spanners
- Trigger operated rivet with hardened steel jaw assembly and rivet shaft safety cap

Nose Pieces	3/32", 1/8", 5/32", 3/16" (2.4, 3.2, 4.0, 4.8mm)
Avg. Air Consumption	4.0 cfm (113 l/min)
Air Pressure	90 PSI
Traction Power	1,940 lbs (8,629n)
Air Inlet	1/4" NPT (PT)
Hose Size	3/8" ID



### A3708 3/16" Hydraulic Air Riveter w/ Handle

- Lightweight and ergonomically designed
- Can be suspended or hand-held
- Heavy duty fiber composite body for performance and long life
- Bi-directional 360° rotation air hose universal joint
- Safety valve automatically releases pressure when pressure exceeds 110 PSI to protect operator and tool

Work Capacity	For Setting Standard Blind Rivets 2.4 - 4.8mm (3/32" - 3/16") in All Materials
Stroke	3/4" (19mm)
Working Air Pressure	85 - 90 PSI
Traction Power	2,400 lbs (10,675n)
Nose Pieces	3/32", 1/8", 5/32", 3/16" (2.4, 3.2, 4.0, 4.8mm)
Air Inlet	1/4" NPT (PT)
Hose Size	3/8" ID



### A3709 1/4" Heavy Duty Hydraulic Air Riveter w/ Handle

- Lightweight and ergonomically designed
- Can be suspended or hand-held
- Heavy duty fiber composite body for durability and long life
- Bi-directional 360° rotation air hose universal joint
- Safety valve, automatically releases pressure when the pressure is over the set 110 PSI to protect from the operator and tool

Work Capacity	For Setting Standard Blind Rivets 4.8 - 6.4mm (3/16" - 1/4") in All Materials
Stroke	19/32" (15mm)
Working Air Pressure	85 - 95 PSI
Traction Power	2,400 lbs (10,675n)
Nose Pieces	3/16", 7/32", 1/4" (4.8, 5.6, 6.4mm)
Air Inlet	1/4" NPT (PT)
Hose Size	3/8" ID







### A6033 HVLP Air Spray Gun

- High volume, low pressure for increased efficiency
- Environmental regulations compliant

Spray Pattern	5" - 6" (125 - 150mm)
Air Pressure	29 PSI
Needle Nozzle	0.8mm, 1.0mm, 1.2mm
Cup Capacity	125cc
Avg. Air Consumption	4.3 cfm (122 l/min)
Fluid Inlet	1/4" NPS
Air Inlet	1/4" NPS
Hose Size	3/8" ID

- Optional needle / nozzle assemblies  
A6033-A (0.8mm), A6033-B (1.0mm), A6033-C (1.2mm)



### A6035 HVLP Touch Up Air Spray Gun

- Ideal for shading and spotting
- High volume, low pressure for efficiency
- Very low over spray and fine atomization
- Chrome with anodized air cap
- Stainless steel needle and fluid tip

Spray Pattern	5" - 6" (125 - 150mm)
Air Pressure	29 PSI
Needle Nozzle	1.0mm
Cup Capacity	250cc
Avg. Air Consumption	4.3 cfm (122 l/min)
Fluid Inlet	1/4" NPS
Air Inlet	1/4" NPS
Hose Size	3/8" ID

- Optional needle / nozzle assemblies  
A6035-A (0.8mm), A6035-B (1.0mm), A6035-C (1.2mm)



### A6022 Mini HVLP Air Spray Gun

- High volume, low pressure for increased efficiency
- Stainless steel needle and fluid tip
- Very low over spray and fine atomization
- Manufactured with high tolerance CNC machined parts

Spray Pattern	4" - 5" (100 - 125mm)
Air Pressure	29 PSI
Needle Nozzle	1.0mm
Cup Capacity	125cc
Avg. Air Consumption	2.5 cfm (45 l/min)
Fluid Inlet	M14 * 1.0
Air Inlet	1/4" NPS
Hose Size	3/8" ID

- Optional needle / nozzle assemblies  
A6022-A (0.8mm), A6022-B (1.0mm), A6022-C (1.2mm)

## A6023 HVLP Air Spray Gun

- High volume, low pressure for greater efficiency
- Very low over spray and fine atomization
- Chrome with anodized air cap
- Gravity feed action for less air and better control over atomization and fluid output

Spray Pattern	6" - 8" (150 - 200mm)
Air Pressure	29 PSI
Needle Nozzle	1.4mm
Cup Capacity	600cc
Avg. Air Consumption	8.0 cfm (227 l/min)
Fluid Inlet	M16 * 1.5
Air Inlet	1/4" NPS
Hose Size	3/8" ID

- Optional needle / nozzle assemblies  
**A6023-A** (1.4mm), **A6023-B** (1.7mm), **A6023-C** (2.0mm)



## A6058 HVLP Air Spray Gun

- Designed for automotive and production applications
- Use with acrylics, enamels, lacquers, primers, rimers, shellacs, stains and varnishes
- Stainless steel needle and fluid nozzle
- 1 qt. heavy duty aluminum siphon feed cup

Spray Pattern	6" - 8" (150 - 200mm)
Air Pressure	29 PSI
Needle Nozzle	1.3mm, 1.4mm, 1.5mm, 1.8mm, 2.0mm, 2.5mm
Cup Capacity	1000cc
Avg. Air Consumption	6.2 cfm (176 l/min)
Fluid Inlet	3/8" NPS
Air Inlet	1/4" NPS
Hose Size	3/8" ID

- Optional needle / nozzle assemblies  
**A6058-A** (1.3mm), **A6058-B** (1.4mm), **A6058-C** (1.5mm)  
**A6058-D** (1.8mm), **A6058-E** (2.0mm), **A6058-F** (2.5mm)



## A6025 HVLP Gravity Feed Air Spray Gun w/ Regulator

- High volume, low pressure for increased efficiency
- Regulator with pressure gauge
- Environmental regulations compliant

Spray Pattern	8" - 10" (200 - 250mm)
Air Pressure	29 - 50 PSI
Needle Nozzle	1.3, 1.5, 1.7, 1.9, 2.2mm
Cup Capacity	20 oz. (600cc)
Avg. Air Consumption	6 - 8 cfm (227 l/min)
Fluid Inlet	M16 x 1.5P
Air Inlet	1/4" NPS
Hose Size	1/4" ID

- Optional needle / nozzle assemblies:  
**A6025-A** (1.3mm), **A6025-B** (1.5mm),  
**A6025-C** (1.7mm), **A6025-D** (1.9mm),  
**A6025-E** (2.2mm), and also **A6025-G** (20oz. cup)





### A6029 Mini Touch-Up HVLP Spray Gun w/ Regulator

- High volume, low pressure for increased efficiency
- Regulator with pressure gauge
- Environmental regulations compliant

Spray Pattern	3" - 4" (75 - 100mm)
Air Pressure	29 - 43 PSI
Needle Nozzle	0.8, 1.0, 1.2mm
Cup Capacity	7 oz. (200cc)
Avg. Air Consumption	2.5 - 2.7 cfm (77 l/min)
Fluid Inlet	M14 x 1.0
Air Inlet	1/4" NPS
Hose Size	1/4" ID

Optional needle / nozzle assemblies:

A6029-A (0.8mm), A6029-B (1.0mm), A6029-C (1.2mm)



### A6050 Production Air Spray Gun

- Designed for automotive and production applications
- Use with acrylics, enamels, lacquers, primers, rimers, shellacs, stains and varnishes
- Stainless steel needle and fluid nozzle
- 1 qt. heavy duty aluminum siphon feed cup

Spray Pattern	8" - 10" (200 - 250mm)
Air Pressure	50 - 70 PSI
Tip Nozzle	1.8mm
Cup Capacity	1000cc
Avg. Air Consumption	8.5 - 12 cfm (340 l/min)
Fluid Inlet	3/8" NPS
Air Inlet	1/4" NPS
Hose Size	3/8" ID



### A6059 Production Spray Gun

- Designed for automotive and production applications
- Use with acrylics, enamels, lacquers, primers, rimers, shellacs, stains and varnishes
- Stainless steel needle and fluid nozzle
- 1 qt. heavy duty aluminum siphon feed cup

Spray Pattern	4" - 5" (100 - 125mm)
Air Pressure	60 PSI
Needle Nozzle	1.5mm, 1.8mm, 2.2mm
Cup Capacity	1000cc
Avg. Air Consumption	12.3 cfm (348 l/min)
Fluid Inlet	3/8" NPS
Air Inlet	1/4" NPS
Hose Size	3/8" ID

Optional needle / nozzle assemblies

A6059-A (1.5mm), A6059-B (1.8mm), A6059-C (2.2mm)



## A6034 3pc LVLP Spray Gun Set

- Low volume, low pressure
- Operating Pressure: 15 - 45 PSI
- Spray Pattern: 7" - 11"
- Precision machined air cap set
- Both guns feature a 1 Liter aluminum paint cup
- Contents: (Color Coded)
  - 1 - Paint Gun with 1.3mm Needle & Nozzle Set (Red)
  - 1 - Paint Gun with 1.7mm Needle & Nozzle Set (Blue)
  - 1 - Locking Pressure Regulator

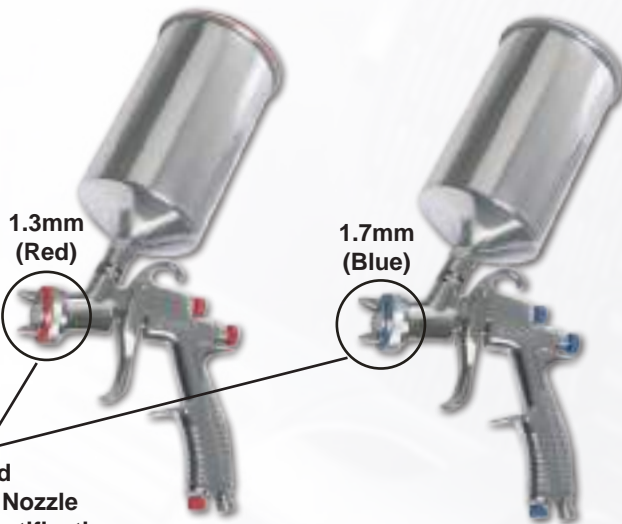

## A6072 2 Quart Pressure Pot w/ HVLP Spray Gun

- Designed for automotive and production applications
- Use with acrylics, enamels, lacquers, primers, rimers, shellacs, stains and varnishes
- Stainless steel needle and fluid nozzle
- 2 qt. heavy duty aluminum siphon feed cup
- Air cap is made of brass for long life
- Regulator with pressure gauge

Spray Pattern Spray Length	6" - 8"
Air Pressure	29 PSI
Needle Nozzle	1.0mm
Cup Capacity	2000cc
Avg. Air Consumption	6.2 cfm (176 l/min)
Fluid Inlet	1/4" NPS
Air Inlet	1/4" NPS
Hose Size	3/8" ID



### A1604 Air Brush Kit

- Double-action trigger air-paint control
- Precisely machined fine nozzle
- Great for artwork design painting

Fluid Nozzle	0.3mm
Working Pressure	15 - 30 PSI
Cup Capacity	22cc & 50cc
Cup Fix	Detachable



### A1605 Air Brush Kit

- Double-action trigger air-paint control
- Precisely machined fine nozzle
- Great for artwork design painting

Fluid Nozzle	0.3mm
Working Pressure	15 - 30 PSI
Cup Capacity	5cc
Cup Fix	Back Stop Screw



### A1606 Air Brush Kit

- Double-action trigger air-paint control
- Precisely machined fine nozzle
- Great for artwork design painting

Fluid Nozzle	0.3mm
Working Pressure	5 - 30 PSI
Cup Capacity	90cc



### A1607 Air Brush Kit

- Double-action trigger air-paint control
- Precisely machined fine nozzle
- Great for artwork design painting

Fluid Nozzle	0.3mm
Working Pressure	15 - 30 PSI
Cup Capacity of Cup	2cc, 5cc, 13cc



### A1643 Oilless Diaphragm Air Compressor

- Ideal for artwork design painting
- Powerful, heavy duty construction
- Capacity: 1/6 HP

Air Displacement	240V / 50Hz, 0.75 cfm (21 l/min)
Connection	1/8" ID
Max. Pressure	50 PSI (3.5 kgs)

## A6225 Air Stapler

- Lightweight design for fatigue-free operation
- Rear exhaust directs air away from work surface
- Steel top cap can be used as a hammer
- Hardened one piece piston

Dimension	48 x 163 x 242mm
Required Pressure	60 - 100 PSI (4 - 7 bar)
Max. Pressure	120 PSI (8.3 bar)
Nail Capacity	200pcs



## A3910 1-1/4" (32mm) Brad Nailer

- One piece drive blade for extended life
- Tool-free quick release
- Tool-free depth control to freely set nail depth
- Tool-free adjustable exhaust

Dimension	272 x 248 x 60mm
Required Pressure	60 - 100 PSI (4 - 7 bar)
Max. Pressure	120 PSI (8.3 bar)
Nail Capacity	100pcs



## A3911 2" (51mm) Brad Nailer

- One piece drive blade for extended life
- Tool-free quick release
- Tool-free depth control to freely set nail depth
- Tool-free adjustable exhaust

Dimension	272 x 256 x 60mm
Required Pressure	60 - 100 PSI (4 - 7 bar)
Max. Pressure	120 PSI (8.3 bar)
Nail Capacity	100pcs







### A3915 2-1/2" (63mm) Finish Nailer

- Lightweight & well balanced for easy operating
- Superior power with hardened one piece piston for professional application
- Adjustable knob for either sequential or contact firing
- Tool-free depth of drive adjustment for exact setting of nail head
- Tool-free jam release mechanism designed not to lock line on sight
- PTFE seal o-ring protects the piston from wear
- Multi-directional exhaust port directs air away from operator and work surface

Dimension	316 x 76 x 292mm
Required Pressure	60 - 100 PSI (4 - 7 bar)
Max. Pressure	120 PSI (8.3 bar)
Nail Capacity	100pcs



### A3916 2-1/2" (63mm) Angle Finish Nailer

- One piece drive blade for extended life
- Tool-free quick release
- Tool-free depth control to freely set nail depth
- Tool-free adjustable exhaust
- Strong, lightweight plastic magazine

Dimension	272 x 256 x 60mm
Required Pressure	60 - 100 PSI (4 - 7 bar)
Max. Pressure	120 PSI (8.3 bar)
Nail Capacity	100pcs



### A3922 3-1/2" (89mm) Magnesium Framing Nailer

- Lightweight & well balanced for easy operating
- Superior power with hardened one piece piston for professional application
- Open nose design for easy jammed nail extraction
- Tool free depth of drive adjustment for flush or countersunk drives into varying material
- Hardened claw tip reduces wear and limits slippage when driving at a slanted angle
- Rubber padding at the end of the magazine and both sides of the main body protect from personal injury

Dimension	156 x 356 x 486mm
Required Pressure	70 - 110 PSI (5 - 7.5 bar)
Max. Pressure	120 PSI (8.3 bar)
Nail Capacity	2 x 40pcs



### A3923 1-3/4" (44mm) Magnesium Roofing Nailer

- Ideal for roofing, underlaying, wall sheathing, framing and recreational decks
- Strong, lightweight magnesium frame
- Use with standard 15° wire-collated roofing nails
- Steel contact safety with dual carbide inserts for less wear
- Soft grip for comfort and control
- Adjustable knob for sequential or contact firing
- Adjustable tool-free exhaust diffuser

Dimension	120 x 286 x 306mm
Required Pressure	70 - 110 PSI (5 - 7.5 bar)
Max. Pressure	120 PSI (8.3 bar)
Nail Capacity	120pcs



### A3930 Flooring Cleat

- Shoots both L & T type flooring nails
- Lightweight die cast aluminum body for less fatigue
- Non-marring base allows driving of fasteners close to wall
- Shoot gauge 16 cleats, 1-1/2" - 2"

Dimension	80 x 432 x 540mm
Required Pressure	80 - 100 PSI (5.5 - 7 bar)
Max. Pressure	120 PSI (8.3 bar)
Nail Capacity	120pcs



### A3738 Air Dent Puller

- Ideal for home, auto, boat or workshop applications
- Air blower for workbenches, tools and more

Slide Hammer Weighr	3-1/2" lb (7.7kg)
Pad Size	115mm & 155mm
Air Pressure	90 PSI
Air Inlet	1/4" NPT (PT)
Hose Size	3/8" ID





### Air Grease Gun

- Heavy duty cast aluminum body for maximum performance and longer service life
- 3-Way grease loading cartridge, suction filling and bulk
- Bleeder valve purges unwanted air
- Pistol grip design with non-slip rubber covered handle
- Designed to penetrate the most stubborn grease fittings
- Single shot design(Only for A3722,A3723)
- Continuous shot design(Only for A3721)

Model	A3721	A3722	A3723
Standard Cartridge	14 oz. (400cc)	14 oz. (400cc)	16 oz. (500cc)
Air Pressure	3,600 PSI	3,600 PSI	3,600 PSI
Pour	288cc/min	2cc	2cc
Air Inlet	1/4" NPT (PT)	1/4" NPT (PT)	1/4" NPT (PT)
Hose Size	3/8" ID	3/8" ID	3/8" ID



### Lightweight Air Grease Gun

- Heavy duty fiber composite body for performance and long life
- 3-Way grease loading cartridge, suction filling and bulk
- Bleeder valve purges unwanted air
- Non-slip knurled handle for secure grip
- Single shot design

Model	A3724	A3725
Standard Cartridge	14 oz. (400cc)	16 oz. (500cc)
Pour	2cc	2cc
Air Pressure	3600 PSI	3800 PSI
Air Inlet	1/4" NPT (PT)	1/4" NPT (PT)
Hose Size	3/8" ID	3/8" ID



### A3715 Air Caulking Gun

- Great for the automotive workshop
- Accepts standard size 50.8 x 210mm cartridges

Operating Pressure.	2.5 - 5.1 bar
Size of tube	Ø50.8 x 210mm
Capacity of Cartridge	310 ml
Air Inlet	1/4" NPT (PT)
Hose Size	3/8" ID



### A3716 Air Undercoating Gun

- Easy to use
- Fits 1 liter canister

Air Consumption	4.0 cfm
Working Pressure	70 - 90 PSI
Air Inlet Size	1/4" NPT (PT)
Hose Size Minimum	3/8" ID



**A3735 Air Engraving Pen**

- Great for nonferrous metals, glass, ceramic, plastic, etc.
- Long lasting carbide tip
- Variable speed regulator for precise control

Vibration	2.5 m/s <sup>2</sup>
Avg. Air Consumption	1.0 cfm (28 l/min)
Air Pressure	90 PSI
Air Inlet	1/4" NPT (PT)
Hose Size	3/8" ID

**A2322 Air Stripping Tool**

- Easily removes marks from plastic plates or painted surface
- Removes quickly without damaging the surface
- Special 90mm x 15mm rubber is included

Chuck Size	3/8" (10mm)
Spindle Tread	5/16" - 24
Free Speed	2,600 rpm
Avg. Air Consumption	3.1 cfm (88 l/min)
Air Pressure	90 PSI
Air Inlet	1/4" NPT (PT)
Hose Size	3/8" ID

**A3700 Air Tire Buffer**

- High power, heavy duty construction for easy and effective tire buffering

Drill Capacity	7/16" (11mm)
Spindle/Thread Size	3/8" - 24
Free Speed	2,600 rpm
Avg. Air Consumption	3.1 cfm (88 l/min)
Air Pressure	90 PSI
Air Inlet	1/4" NPT (PT)
Hose Size	3/8" ID

**A3714 Gravity Feed Air Sand Blaster**

- Compact, portable design with large capacity
- Gravity feed offers uninterrupted and consistent material flow for high operating efficiency
- Pistol grip for easy and comfortable control

Nozzle Size	2-15/16" L x 7/32" Dia.
Case Capacity	18 oz. (514cc)
Avg. Air Consumption	7 cfm (198 l/min)
Air Pressure	90 PSI
Air Inlet	1/4" NPT (PT)
Hose Size	3/8" ID





### A2650 1/4" Air Filter-Regulator

- Filter keeps water, dirt and other particles from entering air line
- Regulator for precise air pressure control
- Improves spray painting performance

Max. Input Pressure	215 PSI
Max. Output Pressure	7 - 142 PSI
Operating Temp Range	5 - 60°C
Filter Element	5 u
Max. Flow	1,750 l/min
Drain Capacity	80 ml
Air Inlet	1/4" NPT (PT)



### A2654 3/8" Air Filter-Regulator

- Filter keeps water, dirt and other particles from entering air line
- Regulator for precise air pressure control
- Improves spray painting performance

Max. Input Pressure	215 PSI
Max. Output Pressure	7 - 150 PSI
Operating Temp Range	5 - 60°C
Filter Element	5 u
Max. Flow	2,500 l/min
Drain Capacity	80 ml
Air Inlet	3/8" NPT (PT)



### A2664 3/8" Air Filter-Regulator & Lubricator

- Features filter, regulator and lubricator to ensure protection from moisture, rust and friction
- Filter for corrosion prevention and removal of abrasive particles for longer service life
- Regulator for accurate airflow control
- Adjustable lubricator for increased durability

Max. Input Pressure	215 PSI
Max. Output Pressure	7 - 150PSI
Operating Temp Range	5 - 60°C
Filter Element	5 u
Max. Flow	2,500 l/min
Drain Capacity	80 ml
Air Inlet	3/8" NPT (PT)
Oil Capacity	125ml



### A1438 Air Regulator w/ Gauge (0-60 PSI)

- Includes a 0-60 PSI pressure gauge
- Provides fine air control for spray gun and air tools
- Regulate constant level of air pressure

### A1440 Air Regulator w/ Gauge (0-160 PSI)

- Includes a 0-160 PSI pressure gauge

## Pocket Air Blow Gun

- Pen size fits easily in pocket
- Highly adjustable air flow at the turn of the nozzle
- Plug end is designed for use with quick couplers

**A1461** Pocket Air Blow Gun (Milton-Type Plug End)

**A1462** Pocket Air Blow Gun (Aro-Type Plug End)

**A1463** Pocket Air Blow Gun (German-Type Plug End)

Operating Pressure	60 - 90 PSI
Avg. Air Consumption	5.0 cfm (142 l/min)
Air Pressure	90 PSI
Hose Size	1/4" ID



## A1432 Lever Type Blow Gun w / Tip

- Suitable for cleaning liquid, swarf or dust during manufacture or assembly
- Compact and versatile blow gun with both safety nozzle and rubber tip nozzle

Working Pressure	60 - 120 PSI
Avg. Air Consumption	4.3 cfm (122 l/min)
Air Pressure	90 PSI
Air Inlet	1/4" NPT(PT)
Hose Size	1/4" ID



## A1480 4" Air Blow Gun

- Easily cleans and removes dust from equipment
- Nylon body with trigger
- Comfortable lever control and insulated handle
- Angled nozzle easily gets into tight places

Operating Pressure	75 - 120 PSI
Avg. Air Consumption	6.9 cfm (195 l/min)
Air Pressure	90 PSI
Air Inlet	1/4" NPT (PT)
Hose Size	1/4" ID



## A1458 4" Adjustable Air Blow Gun

- Easily cleans and removes dust from equipment
- Nylon body with trigger
- Comfortable lever control and insulated handle
- Adjustable air flow control

Operating Pressure	75 - 120 PSI
Avg. Air Consumption	6.9 cfm (195 l/min)
Air Pressure	90 PSI
Air Inlet	1/4" NPT (PT)
Hose Size	1/4" ID







### A1485 Safety Tip Air Blow Gun

- Easily cleans and removes dust from equipment
- Nylon body with trigger
- Comfortable lever control and insulated handle
- Meets O.S.H.A. requirements

Operating Pressure	75 - 120 PSI
Avg. Air Consumption	4.8 cfm (136 l/min)
Air Pressure	90 PSI
Air Inlet	1/4" NPT (PT)
Hose Size	1/4" ID



### A1484 3-in-1 Air Blow Gun

- Ideal for air blow gun, air tip, and tire inflator chuck
- Comfortable lever control and insulated handle

Operating Pressure	75 - 120 PSI
Avg. Air Consumption	6.9 cfm (195 l/min)
Air Pressure	90 PSI
Air Inlet	1/4" NPT (PT)
Hose Size	1/4" ID



### A1481 13" Air Blow Gun

- Easily cleans and removes dust from equipment
- Nylon body with trigger
- Comfortable lever control and insulated handle
- Angled nozzle easily gets into tight places

Operating Pressure	75 - 120 PSI
Avg. Air Consumption	6.9 cfm (195 l/min)
Air Pressure	90 PSI
Air Inlet	1/4" NPT (PT)
Hose Size	1/4" ID



### A1495 Adjustable Tip Air Blow Gun

- Removes waste, cut powder, cut trash, and water drop
- Good for cleaning, cooling, and drying air
- Aluminum die-casting body
- 2-Way duster

Operating Pressure	75 - 120 PSI
Avg. Air Consumption	5.8 cfm (164 l/min)
Air Pressure	90 PSI
Air Inlet	1/4" NPT (PT)
Hose Size	1/4" ID



### A1465 Air Blow Gun Kit

- Includes most popular air blow gun tips for use in every place
- Includes:
 

1 - Blow gun	1 - Brass tip
1 - Safty tip	1 - Adj. tip
1 - Rubber tip	1 - Air screen tip
1 - Safety booster tip	1 - 3" Nylon tip

Working Pressure	60 - 120 PSI
Avg. Air Consumption	4.3 cfm (122 l/min)
Air Pressure	90 PSI
Air Inlet	1/4" NPT (PT)
Hose Size	1/4" ID



### A1486 Short Nozzle Siphone Spray Set

- 4" short nozzle tube for general cleaning operation
- Siphone nozzle sprays solvents, soap solutions for cleaning machinery, walls and painting for base coating

Operating Pressure	75 - 120 PSI
Avg. Air Consumption	6.9 cfm (195 l/min)
Air Pressure	90 PSI
Air Inlet	1/4" NPT (PT)
Hose Size	1/4" ID



### A1437 Safety Air Blow Gun w/ Extended Nozzle

- Extended nozzle with safety restricted air flow tip
- Produces side vent shield of air that confines material being blown, keeping it away from face
- Trigger regulated air flow





### Air Female Coupler (Brass) - Milton Type

Female



Model	Size
A2540	1/4"
A2541	3/8"
A2542	1/2"

### Air Male Coupler (Brass) - Milton Type

Male



Model	Size
A2543	1/4"
A2544	3/8"
A2545	1/2"

### Air Female Connector (Brass) - Milton Type

Female



Model	Size
A2546	1/4" (2pc / Set)
A2547	3/8" (2pc / Set)
A2548	1/2" (2pc / Set)

### Air Male Connector (Brass) - Milton Type

Male



Model	Size
A2549	1/4" (2pc / Set)
A2550	3/8" (2pc / Set)
A2551	1/2" (2pc / Set)

### Air Hose Coupler (Brass) - Milton Type



Model	Size
A2552	1/4"
A2553	5/16"
A2554	3/8"
A2555	1/2"

### Air Hose Connector (Brass) - Milton Type



Model	Size
A2559	1/4" (2pc / Set)
A2560	5/16" (2pc / Set)
A2561	3/8" (2pc / Set)
A2562	1/2" (2pc / Set)



### A2570 5pc Air Coupler Set (Brass) - Milton Type

- Contents:
  - 1pc 1/4" Female Air Coupler
  - 1pc 1/4" Female Connector
  - 3pc 1/4" Male Connector

## Air Female Coupler (Brass) - German Type



Female

Model	Size
<b>A6510</b>	1/4"
<b>A6511</b>	3/8"
<b>A6512</b>	1/2"

## Air Male Coupler (Brass) - German Type



Male

Model	Size
<b>A6513</b>	1/4"
<b>A6514</b>	3/8"
<b>A6515</b>	1/2"

## Air Female Connector (Brass) - German Type



Female

Model	Size
<b>A6516</b>	1/4" (2pc / Set)
<b>A6517</b>	3/8" (2pc / Set)
<b>A6518</b>	1/2" (2pc / Set)

## Air Male Connector (Brass) - German Type



Male

Model	Size
<b>A6519</b>	1/4" (2pc / Set)
<b>A6520</b>	3/8" (2pc / Set)
<b>A6521</b>	1/2" (2pc / Set)

## Air Hose Coupler (Brass) - German Type



Model	Size
<b>A6522</b>	1/4"
<b>A6523</b>	5/16"
<b>A6524</b>	3/8"
<b>A6525</b>	1/2"

## Air Hose Connector (Brass) - German Type



Model	Size
<b>A6529</b>	1/4" (2pc / Set)
<b>A6530</b>	5/16" (2pc / Set)
<b>A6531</b>	3/8" (2pc / Set)
<b>A6532</b>	1/2" (2pc / Set)

## **A2571** 5pc Air Coupler Set (Brass) - German Type

- Contents:
  - 1pc 1/4" Female Air Coupler
  - 1pc 1/4" Female Connector
  - 3pc 1/4" Male Connector







### Air Female Coupler (Brass) - Aro Type



Female

Model	Size
A6550	1/4"
A6551	3/8"
A6552	1/2"

### Air Male Coupler (Brass) - Aro Type



Male

Model	Size
A6553	1/4"
A6554	3/8"
A6555	1/2"

### Air Female Connector (Brass) - Aro Type



Female

Model	Size
A6556	1/4" (2pc / Set)
A6557	3/8" (2pc / Set)
A6558	1/2" (2pc / Set)

### Air Male Connector (Brass) - Aro Type



Male

Model	Size
A6559	1/4" (2pc / Set)
A6560	3/8" (2pc / Set)
A6561	1/2" (2pc / Set)

### Air Hose Coupler (Brass) - Aro Type



Model	Size
A6562	1/4"
A6563	5/16"
A6564	3/8"
A6565	1/2"

### Air Hose Connector (Brass) - Aro Type



Model	Size
A6569	1/4" (2pc / Set)
A6570	5/16" (2pc / Set)
A6571	3/8" (2pc / Set)
A6572	1/2" (2pc / Set)



### A2572 5pc Air Coupler Set (Brass)- Aro Type

- Contents:
  - 1pc 1/4" Female Air Coupler
  - 1pc 1/4" Female Connector
  - 3pc 1/4" Male Connector

## Air Female Coupler (Steel) - Nitto Type

Female



Model	Size
<b>A2510</b>	1/4"
<b>A2511</b>	3/8"
<b>A2512</b>	1/2"

## Air Male Coupler (Steel) - Nitto Type

Male



Model	Size
<b>A2513</b>	1/4"
<b>A2514</b>	3/8"
<b>A2515</b>	1/2"

## Air Female Connector (Steel) - Nitto Type

Female



Model	Size
<b>A2516</b>	1/4" (2pc / Set)
<b>A2517</b>	3/8" (2pc / Set)
<b>A2518</b>	1/2" (2pc / Set)

## Air Male Connector (Steel) - Nitto Type

Male



Model	Size
<b>A2519</b>	1/4" (2pc / Set)
<b>A2520</b>	3/8" (2pc / Set)
<b>A2521</b>	1/2" (2pc / Set)

## Air Hose Coupler (Steel) - Nitto Type



Model	Size
<b>A2522</b>	5/16"
<b>A2523</b>	3/8"
<b>A2524</b>	1/2"

## Air Hose Connector (Steel) - Nitto Type



Model	Size
<b>A2528</b>	5/16" (2pc / Set)
<b>A2529</b>	3/8" (2pc / Set)
<b>A2530</b>	1/2" (2pc / Set)

## Air Hose Coupler (Steel) - Nitto Type



Model	Size
<b>A2525</b>	5mm x 8mm
<b>A2526</b>	6.5mm x 10mm
<b>A2527</b>	8mm x 12mm

## Air Hose Connector (Steel) - Nitto Type



Model	Size
<b>A2531</b>	5mm x 8mm (2pc / Set)
<b>A2532</b>	6.5mm x 10mm (2pc / Set)
<b>A2533</b>	8mm x 12mm (2pc / Set)



### A2573 Air Coupler Set (Steel) - Nitto Type

- Contents:
  - 1pc 1/4" Female Air Coupler
  - 1pc 1/4" Female Connector
  - 3pc 1/4" Male Connector



### A2508 1/4" Air Swivel Connector

- Keeps air line straight without kinking
- 360° Rotation at both points for complete tool maneuverability



### A1464 18pc Air Tool Accessory Kit (German Type)

### A1460 18pc Air Tool Accessory Kit (Milton Type)

- Complete kit for professional or home use
- Includes most popular air tool accessories
- Corrosion resistant brass couplers & connectors



A1464

A1460

### A2509 1/4" Air Swivel Connector

- Keeps air line straight without kinking
- 360° Rotation at both points for complete tool maneuverability



### Air Hose Repair Connector (Brass)



Splicer

Model	Size
A6533	1/4"
A6534	5/16"
A6535	3/8"
A6536	1/2"

### A1001 3" Cutoff Wheel Set

### A1002 50pc 3" Cutoff Wheels

- Use with utility cut-off tools
- 3" (75mm) Diameter, 1/16" thickness
- 3/8" Arbor hole fits all brands of air cut-off tools
- Great for cutting sheet metal, metal hardware and fasteners



### A1705 9pc 2" Air Sanding Pad Set

- Use with angle head die grinder/sanders
- Includes 6pc 2" sanding disc pads and 3pc 2" surface conditioning disc pads
- Ideal for paint and body shops



### A1101 10pc Grinding Stone Set

- Use with air die grinders
- Shaped to suit all grinding applications



### A1426 Air Regulator

- Standard 1/4" male and 1/4" female fittings
- Knurled grip for precise airflow adjustment
- Corrosion resistant brass construction
- Increases / decreases air pressure as desired



### A1428 Oil & Water Separator

- Separates water from compressed air
- Includes drain valve for periodic draining
- 150 PSI Maximum in-line pressure
- Removes water and oil condensates
- Provides uniform spray painting results



### A1429 In-Line Air Mini Oiler

- Lubricates air tools to ensure durability
- Attaches between tool and air hose to lubricate tool during use
- Not to be used for spray painting tools



### A1435 Air Tire Chuck

- Corrosion resistant, durable brass construction
- Angled head with rubber gasket for easy access and leak-free seating on type valves
- 1/4" Female



### A1430 Tire Inflator w/ Gauge

- 10-120 lbs pressure gauge with easy-to-read scale and 2 lbs increments
- 12" heavy duty rubber air hose, 1/4" female
- Cast aluminum alloy body with heavy duty valve to resist corrosion



### A1436 Dual Head Air Tire Chuck

- Corrosion resistant brass tube
- Angled dual head
- Rubber gasket ensures airtight seal
- 1/4" Female



### A1431 Air Tire Inflator with Gauge

- Makes accurate inflation pressure simple and fast
- Well-balanced pistol grip for easy handling
- Ideal for automotive tires, farm equipment tires, bicycle tires and most other inflatables







### A1706 2" Air Sanding Pad Adaptor w/ Shank

- Grinds, smoothes and finishes rough areas
- Flexible disc holders are made of reinforced rubber
- Can use with both sanding discs and conditioning discs
- Maximum 30,000 rpm
- Includes 6mm (1/4") shank
- For use with A3028



### A1441 PTFE Seal Tape (1/2" x 260")

- Adds extra seal at threaded joints



### A1407 Jitterbug Sander Pad

- Use with A4244 or A4243 jitterbug sanders



### A1401 Straight Line Sander Pad

- Use with A4249 straight line sanders



### Polyurethane (PU) Coiled Hose (Braided)

- Polyurethane resin nylon braided hose
- Brass swivel end fittings with plastic protection guard
- 200 PSI maximum working pressure

**A3326** 1/4" x 25Ft PU Air Hose

**A3327** 1/4" x 50Ft PU Air Hose

**A3331** 3/8" x 25Ft PU Air Hose

**A3332** 3/8" x 50Ft PU Air Hose



### PVC Air Hose

- Double strand polyester braiding
- 1/4" Solid brass fittings
- 300 PSI maximum working pressure

**A3533** 3/8" x 25Ft (7.6m) PVC Air Hose

**A3534** 3/8" x 50Ft (15m) PVC Air Hose

**Nylon Recoil Air Hose**

- 1/4" brass end fittings
- Self-retracting nylon hose
- Chemical and corrosion resistant
- 200 PSI maximum air pressure
- Use with all air tools and related equipment

**A3221** 1/4" 25Ft Nylon Recoil Air Hose**A3222** 1/4" 50Ft Nylon Recoil Air Hose**Rubber Air Hose**

- 3/8" ID hose with 1/4" brass fittings
- Up to 250 PSI working pressure
- Resists oil, kink, abrasion, weather and ozone

**A3531** 25Ft (7.6m) 3/8" Rubber Air Hose**A3532** 50Ft (15m) 3/8" Rubber Air Hose**Whip Air Hose**

- Tough, flexible rubber hose that won't kink or crack
- Use between air tool and coupling
- Reinforced braiding for durability
- Up to 250 PSI working pressure
- Resists oil, kink, abrasion, weather and ozone

**A3347** 1/4" x 2Ft (600mm) Whip Air Hose**A3350** 3/8" x 2Ft (600mm) Whip Air Hose**A1414** 12" Air Grease Gun Flexible Hose w/ Coupler

- Ideal for lubricating machine, vehicle, farm and garden-equipment
- Heavy-duty flexible hose reaches confined spaces
- Use with air-powered grease guns





### A1412 Quick Change Retainer Spring

- Use with AmPro AR3101 Professional Air Hammer
- Safety chisel holding device
- Heavy duty spring with remover lever



### A1418 3/8" Keyless Drill Chuck

### A1419 1/2" Keyless Drill Chuck

- High quality chuck constructed for fast and easy bit changing without use of wrench
- Use with 3/8" and 1/2" air drills



### A1424 5pc Saw Blade set (24 Teeth)

### A1425 5pc Saw Blade set (32 Teeth)

- Use with air body saws
- High grade bi-metal blades



### A1702 5pc Air Chisel Set

- Use with air hammers
- Chrome Molybdenum steel
- Standard 0.401" shank
- Contents: Weld Buster, Cold Chisel, Tapered Punch, and Round Nose Panel



## Air Tool Repair Kits



AmPro offers comprehensive repair kits and replacement parts facilities. Repair kits consist of popular wear and tear items.

### Repair Kits:

To order repair kits: Suffix "K" to the model number. For example, the repair kit for model #A2302 is #A2302K. Repair Kits may be purchased at AmPro Service Centers, or authorized AmPro dealers.

### Replacement Parts:

To order replacement parts: Refer to the exploded tool diagram which accompanies each airtool. Each part has an index number. For example model #A2302 and index #1 refers to part #A2302-01. Replacement parts maybe purchased at AmPro Service Centers.





# Power Tools & Power Accessories





**T80252 24V Cordless 1/2" Dr. Impact Wrench**

- Maximum torque: 350ft.lbs (480Nm)
- Working torque: 300ft.lbs (420Nm)
- Ergonomic soft grip for comfort
- Metal front housing for prolonged service life
- Forward-Reverse power control
- Heavy-duty 24V battery pack
- 4pc CRV sockets included



Voltage	24V
Battery	2,400mAh Ni-Mh
Speed	2,300rpm
Chuck	13mm
Charging Time	1Hour
Max. Torque Force	480Nm

**T80506 18V Li-Ion Cordless Drill**

- 13mm Keyless chuck with auto lock
- 24-Torque settings drill mode
- 2-Speed gearbox for various speed control
- Ergonomic cushion grip
- Built-in LED work light
- LCD battery indicator



Voltage	18V
Battery	1,500mAh Li-ion
Speed	0-350rpm / 0-1,250rpm
Torque Force	23-25Nm
Charging Time	1Hour

**T80550 18V Cordless Drill**

- 10mm Keyless chuck for quick and easy bit changing
- Two speed gear box for drilling with variable speed up to 1,200rpm
- Hammer function
- Integrated LED flashlight for drilling in dark places
- Ergonomic, cushioned grip handle for comfort



Voltage	18V
Battery	1,500mAh Ni-Mh
Speed	0-400rpm / 0-1,200rpm
Chuck	10mm
Charging Time	1Hour

**T80549 18V Cordless Circular Saw**

- High performance motor for efficient cutting
- Keyless bevel angle and cutting depth adjustment
- Spindle lock for easy blade replacement
- Ergonomic cushioned grip



Voltage	18V
Battery	1,500mAh Ni-Mh
Speed	3,400rpm
Blade Size	136mm
Charging Time	1Hour

**T80548 18V Cordless Jig Saw**

- High performance motor for efficient cutting
- Pendulum function
- Cushioned grip for maximum comfort



Voltage	18V
Battery	1,500mAh Ni-Mh
Speed	3,000rpm
Cutting Capacity	
Steel	8mm
Wood	80mm
Charging Time	1Hour

**T80552 18V Cordless Reciprocating Saw**

- High performance reciprocating mechanism provides optimized power to weight ratio
- Variable speed trigger for quick controlled
- Lock-off switch ensures safety operating
- Lever-action keyless blade clamp for quick and easy blade replacement
- Pivoting shoe with open top for high stability and blade visibility during the cut
- Anti-slip cushioned grip for comfort



Voltage	18V
Battery	1,500mAh Ni-Mh
Speed	0-3,000rpm
Charging Time	1Hour





### T80540 18V Cordless Angle Grinder

- Aluminum gear housing for performance & durability
- Spindle lock for easy disc replacement
- High performance motor for efficient cutting
- Multi-position handle for convenience
- Slim body design ensures a secure grip at all times



Voltage	18V
Battery	2,400mAh Ni-Mh
Speed	7,000rpm
Disc Size	115mm



### T80555 18V Cordless Planer

- Lock-off button for safety operating
- Micro depth adjustment for precise control
- Precision machined aluminum base for planing accuracy



Voltage	18V
Battery	2,400mAh Ni-Mh
Speed	13,000rpm
Planing Width	82mm
Planing Depth	1mm
Charging Time	1Hour



### T80551 18V Cordless Delta Sander

- Velcro sanding base
- Ergonomic cushioned grip for comfort



Voltage	18V
Battery	1,500mAh Ni-Mh
Speed	9,000rpm
Charging Time	1Hour

**T80545 12V Cordless Orbital Buffer**

- Small and lightweight design
- Cushioned grip handle for maximum comfort



Voltage	12V
Battery	1,300mAh Ni-Mh
Speed	3,500rpm
Chassis Diameter	240mm

**T80510 7.2V Li-ion Cordless Mini Grinder**

- Small and lightweight design
- Cushioned grip for maximum comfort



Voltage	7.2V
Battery	1,500mAh Li-ion
Speed	8,000-22,000rpm
Chuck Size	2.3-3.2mm

**T80385 Powerful 3HP Portable Electric Vacuum-Blower**

- Powerful 3HP electric 120Volt motor
- Works as a vacuum or blower
- Self contained permanent bag
- Quick clamp release for easy cleaning
- Portable & lightweight
- Combination Wall Mount and Portable Vacuum-Blower

Includes:

- 6' Suction Hose
- Shoulder Strap
- 2 - 20" Extension Tubes
- Wall Mounted Vacuum Bracket
- Wall Mounted Attachment Holder
- 8 - Miscellaneous Attachments





**T80275 18V Cordless Grease Gun**

- Cordless - no more cord tangling
- Heavy duty motor generates up to 10,000 PSI pressure
- Continuous grease flow volume: 75 grams (2.65oz.) per minute
- Heavy duty high pressure hose equipped with a two-end spring jacket
- Extra long 42" (106cm) professional-grade flex hose for hard-to-reach places
- 3-Way loading:  
cartridge, suction & filler pump
- Shoulder strap to reduce operator fatigue
- 14.5oz. Capacity reservoir tube



Voltage	18V
Battery	1,500mAh Ni-Mh
Flow Rate	75g/min
Charging Time	1Hour
Max. Operating Pressure	10,000PSI
Grease Reservoir	14.5oz.
Long Flex Hose	106cm

**T80808 1050W Rotary Hammer**

- SDS Plus chuck for quick drill replacement
- Pneumatic hammer function
- Impact / drill / chisel function for various applications
- Cushioned grip for comfort



Voltage / Frequency	230V~50Hz
Power	1,050W
Speed	0-800rpm
Drilling Capacity	
Steel	13mm
Concrete	32mm
Wood	36mm
Chuck	13mm



**T80806 800W 3 Functions Electric Hammer**

- SDS Plus chuck for quick drill replacement
- Pneumatic hammer function
- Impact / drill / chisel function for various applications
- Cushioned grip for maximum comfort



Voltage / Frequency	230V~50Hz
Power	800W
Speed	0-1,000rpm
Drilling Capacity	
Steel	13mm
Concrete	26mm
Wood	30mm
Chuck	13mm

**T80801 1050W Impact Drill**

- 13mm Keyless chuck with auto-lock
- 360° Auxiliary handle with cover for advantage use
- Aluminum alloy gear housing for performance and durability
- Comfortable firm grip handle



Voltage / Frequency	230V~50Hz
Power	1,050W
Speed	0-3,000rpm
Drilling Capacity	
Steel	13mm
Concrete	20mm
Wood	30mm
Chuck	Keyless 13mm

**T80800 720W Impact Drill**

- 13mm Keyless chuck for quick and easy bit changing
- 360° Auxiliary handle with cover for advantage use
- Aluminum alloy gear housing ensures performance and durability
- Cushioned grip for maximum comfort



Voltage / Frequency	230V~50Hz / 120V~60Hz
Power	720W
Speed	0-2,700rpm
Drilling Capacity	
Steel	13mm
Concrete	16mm
Wood	25mm
Chuck	Keyless 13mm



**T80815 2200W Angle Grinder**

- Aluminum alloy gear housing for performance and durability
- Spindle lock for easy disc replacement
- Multi-position handle with cover for advantage use
- Safety large trigger switch for comfortable operation



Voltage / Frequency	230V~50Hz
Power	2200W
No-Load Speed	5,800rpm
Disc Size	230mm

**T80814 850W Angle Grinder**

- Aluminum alloy gear housing for performance and durability
- Spindle lock for easy disc replacement
- Multi-position handle with cover for advantage use
- Slim body design ensures secure grip



Voltage / Frequency	230V~50Hz
Power	850W
No-Load Speed	11,000rpm
Disc Size	125mm

**T80813 710W Angle Grinder**

- Aluminum alloy gear housing for performance and durability
- Spindle lock for easy disc replacement
- Multi-position handle with cover for advantage use
- Slim body design ensures secure grip



Voltage / Frequency	230V~50Hz / 120V~60Hz
Power	710W
No-Load Speed	10,500rpm
Disc Size	115mm

**T80835 650W Reciprocating Saw**

- 20mm Stroke length for superior cutting performance
- Quick-release blade changing system
- Lock-off switch for safe operation
- Ergonomic cushioned grip handle



Voltage / Frequency	230V~50Hz / 120V~60Hz
Power	650W
Speed	500-3,000rpm
Stroke Length	20mm

**T80832 710W Jig Saw**

- High performance motor for high efficiency cutting
- Pendulum function
- Cushioned grip for maximum comfort



Voltage / Frequency	230V~50Hz / 120V~60Hz
Power	710W
Speed	500-3,000rpm
Drilling Capacity	
Steel	8mm
Wood	80mm

**T80838 1350W Circular Saw**

- Laser light for precise and visible sawing
- Spindle lock for easy blade replacement
- Aluminum alloy footplate for performance and durability
- Adjustable bevel and depth lever
- Ergonomic cushioned grip



Voltage / Frequency	230V~50Hz / 120V~60Hz
Power	1350W
Speed	4,500rpm
Blade Size	185mm
Cutting Capacity	45° - 40mm 90° - 63mm

**Laser Light**





**T80938 1800W Wall Chaser**

- Equipped with a powerful 1800 Watt motor to run two 180mm diamond blades with no bogging
- Motor is protected by a smart electronic overload (No thermal switch to wait for: just release the switch and start again)
- Ergonomic handles allow a variety of holding positions for comfortable cutting
- Roller base for smooth action and precise control
- Various spacers to create channels up to 51mm in width and to a depth of up to 54mm
- Overload protection



Voltage	230V~50Hz / 120V~60Hz
No Load Speed	4,100rpm
Power Input	1800W
Max. Blades Diameter	180mm (7")
Channel Width	9~51mm (3/8"~2")
Max. Cutting Depth	15~54mm (9/16"~2-1/8")

**T80911 1700W 230mm Metal Cutting Circular Saw**

- Super-quick chip clearing with our unique bayonet-type blade cover latch
- Ergonomic handle shape and position with soft TRP grip for maximum comfort and fatigue-free operation
- High stability base with quick, tool-free depth adjustment including clearly marked scales
- High motor output for maximum torque to perform even the most challenging cuts
- Safety features include a lock-off switch and spark/chip containing design



Motors Available	230V~50Hz / 120V~60Hz
No-Load Speed	260rpm
Power	1700W
Bevels	0~45Degrees
Blade	230mm (9")
Arbor	30mm (1-3/16") or 25.4mm (1")
Cutting Capacity	Straight Cut: 84mm (3-3/16")
	45 Degree Bevel: 56mm (2-3/16")

**T80841 1900W 255mm Miter Saw**

- Transparent moveable guard for excellent visibility and operator safety
- Spindle lock for fast and easy blade replacement
- Large comfort switch and rubber D-handle for enhanced control and comfort
- Dust collecting bag ensures clean working environment



Voltage / Frequency	230V~50Hz	
Power	1900W	
Speed	4,500rpm	
Spindle Dia.	16mm	
Slide Cut Length	192mm	
Blade Size	255mm	
Miter / Bevel		
	0° - 90°: 91 x 305mm	0° - 45°: 91 x 205mm
	45° - 0°: 50 x 305mm	45° - 45°: 50 x 205mm

**T80842 1900W Miter Saw**

- Transparent moveable guard for excellent visibility and operator safety
- Spindle lock for fast and easy blade replacement
- Large comfort switch and rubber D handle for enhanced control and comfort
- Dust collecting bag ensures clean working environment



Voltage / Frequency	230V~50Hz / 120V~60Hz	
Power	1900W	
Speed	4,500rpm	
Blade Size	255mm	
Cutting Capacity		
	0° - 90°:	134 x 72mm, 160 x 46mm
	45° - 90°:	93 x 72mm, 112 x 41mm
	0° - 45°:	150 x 41mm
	45° - 45°:	100 x 41mm

**T80921 1600W 254mm Compound & Slide Compound Mitre Saw**

Motors Available	120V / 60Hz
No-Load Speed	3,500rpm (60Hz)
Power	1600W
Bevels	0 to 45°
Miters	0 to 45° Left and Right
Blade	254mm (10")
Arbor	30mm (1-3/16") or 25.4mm (1")
Base Dimensions	460 x 450mm
Slide Cutting Capacity	90 Degree Miter: 300mm x 60mm (11-13/16" x 2-3/8")
	45 Degree Miter: 212mm x 60mm (8-3/8" x 2-3/8")

**Standard Accessories:**

- Arbor lock bar
- M24/27 open-end wrench
- M13 combination wrench
- Vacuum port
- M10 combination wrench
- Vise

**T80827 900W Belt Sander**

- Quick release belt changing system
- Belt centering system adjustment
- Ergonomic cushioned handle



Voltage / Frequency	230V~50Hz
Power	900W
Speed	200-380 m/min
Sanding Pad Size	76 x 533mm

**T80825 200W Finish Sander**

- Lock-on button for continuous operation
- Integrated dust gangway and vacuum connector for dust extraction
- Dual cushioned grip for comfort



Voltage / Frequency	230V~50Hz
Power	200W
Speed	11,000rpm
Sanding Pad Size	90 x 187mm

**T80826 135W Mouse Sander**

- Rocker switch for continuous operation
- Quick fit sanding paper for faster sanding action
- Integrated dust gangway and vacuum connector for dust extraction
- Ergonomic soft trigger and grip



Voltage / Frequency	230V~50Hz
Power	135W
Speed	13,000rpm
Sanding Pad Size	140 x 140 x 80mm

**T80856 900W Electric Planer**

- Lock-off button for safe operation
- Micro depth adjustment for precise control
- Precision machined aluminum base for planing accuracy



Voltage / Frequency	230V~50Hz
Power	900W
Speed	17,000rpm
Planing Width	82mm
Planing Depth	2mm
Rabbeting Depth	15mm

**T80700 3pc Mini Power Tool Set**

- Mini, portable design
- High performance motor for high efficiency operation

**① 280W Planer:**

Voltage / Frequency	230V~50Hz / 120V~60Hz
Power	280W
No-Load Speed	18,000rpm
Planing Width	50mm
Planing Depth	0.6mm

**② 280W Belt Sander:**

Voltage / Frequency	230V~50Hz / 120V~60Hz
Power	280W
No-Load Speed	380m/min
Size	40 x 303mm

**③ 280W Router:**

Voltage/Frequency	230V~50Hz / 120V~60Hz
Power	280W
No-Load Speed	33,000rpm
Max Depth	15mm





**T80850 25W Electric Caulking Gun**

- Ergonomic, balanced design for maximum performance and comfort
- Lock-off button for safe operation
- Variable speed switch for working pressure control



Voltage / Frequency	230V~50Hz
Power	25W
Speed	60-300mm/min

**T80853 2000W Hot Air Gun**

- Variable heat settings from 60-650 degrees
- Three blower levels
- 2000W powerful motor
- LCD display



Voltage / Frequency	230V~50Hz
Power	2000W
Temperature	60-650 °C
Air Volumn	350 / 350 / 550L/min

**T21500 Hot Air Gun Kit (1500w)**

- Delivers powerful, heated airflow with temperature control
- Excellent for
  - Removing / stripping paint and varnish
  - Shrinking / softening adhesives
  - Molding / welding plastics
  - Heat shrink tubing
  - Thawing / drying parts
- Position 1: 750w, 300°C, 280L/min
- Position 2: 1500w, 500°C, 480L/min



**T80820 500W Electric Polisher**

- Slim body design ensures secure grip
- Aluminum alloy gear housing for performance and durability
- Spindle lock for easy disc replacement
- Big rear handle for advantage use
- Lock-on button for extended use
- Variable speed control system for facile operating



Voltage / Frequency	230V~50Hz
Power	500W
No-Load Speed	1,200-5,000rpm
Disc Size	125mm

**T80847 1500W Electric Router**

- Micro depth adjustment for precise control
- Spindle lock for easy bit replacement
- Aluminum base
- Comfortable firm grip handle



Voltage / Frequency	230V~50Hz
Power	1,500W
Speed	6,000-26,000rpm
Plunge Depth	0-50mm
Collet Size	12mm

**T80858 900W Electric Biscuit Jointer**

- Ergonomic easy-to-grip barrel design for maximum comfort
- Convenient thumb control power switch
- 6 Settings cutting depth adjustment wheel regulate biscuit sizes
- Spindle lock for easy blade replacement
- Dust collecting bag ensures clean working environment



Voltage / Frequency	230V~50Hz
Power	900W
Speed	12,000rpm
Blade Size	100mm





### T80922 550W Auto Feed Screwdriver

- Provides the quickset possible fastening for drywall screws
- Tool-free for removal of auto feed magazine and setting screw length
- Auto feed magazine can turn 180 degrees for work in tight spaces
- Thumb operated screw depth selector
- Easy to remove auto feed magazine for use as standard (reversible) screwdriver
- Excellent weight balance and superb ergonomic shape makes this tool easy to use single-handedly
- Belt clip for attaching to belt or holster



Voltage	230V~50Hz
Power Input	550W
No-Load Speed	0 ~ 4,000rpm
Maximum Torque	13.5N.m
Screw Length	15~55mm
Screw Outer Diameter	3~5mm
Quick Change Arbor	1/4"

#### Standard Accessories:

- Phillips bit #2 (25mm L)
- Standard screwdriver head
- 1/4" Magnetic connector
- Extension bit 150mm (L) No. 2 Phillips head
- Blow molded case
- \* Collated Screws not Included

### T80936 1200W Scouring Machine

- Versatile for removal of soft plaster surfaces; elastic protection on walls and floors; foam crests and adhesive remainders; asphalt and protective coatings for concrete; latex or oil paint on gypsum surface; and removal of impurity and contamination on concrete surfaces
- Superior at grinding off irregularities and protections on plaster flooring and roughing, cleaning and smoothing out irregularities of aged concrete
- Movable rubber base platform bends and swivels according to the surface, putting less strain on the operator's wrists
- Ergonomically designed to decrease user fatigue
- Side handle (able to attach to either side of the machine) improves handling of machine
- Dust free operation-attaches directly to standard vacuum hose
- All three types of abrasive materials: carbide cutter discs, diamond cup grinding heads and TC grinding heads are easily replaced when worn out



Voltage	230V~50Hz
Power Input	1,200W
No load Speed	2,800rpm
Milling Head	125mm
Milling Depth	1-6mm

#### Standard Accessories:

- Side handle
- T-wrench
- Pyramid-shaped cutter discs
- Plastic clip
- Wheel puller



### T80916 1100W Electric Beveler

- Quick and convenient solution for adding bevels and deburring
- Excellent for following curved shapes
- Variable speed for working with a variety of materials
- Uses standard triangle carbide inserts
- Quick and easy tool-free bevel depth setting



Voltage	230V~50Hz / 120V~60Hz
No Load Speed	3,000~6,000rpm (Variable Speed)
Power Input	1100W
Bevel Angle	45° (Optional 30°)
Maximum Bevel Height (45°)	6mm
Minimum Diameter for Inside Bevels	20mm



### T80943 550W Electric Drywall Sander

- 4m Hose with bayonet swivel connection
- Designed to work with a vacuum so there is less dust in the air, less sandpaper clogging and no after-cleanup needed
- Pivoting sanding head for swirl-free finish
- Adjustable speed tailored for best results on work surfaces
- Hook and loop backed sandpaper discs and backing pads take only seconds to change
- Less scaffolding is needed since it can access most ceilings just standing on the floor
- Excellent balance and lightweight for effortless operation



Voltage	230V~50Hz / 120V~60Hz
No Load Speed	650~1,600rpm
Full Load Speed	280~950rpm
Power Input	550Wt
Grinding Disc	Ø 225mm (8-7/8")
Length	154cm (61")







## Electric Mixer



- Combination of revolutionary ergonomic design, sturdy mechanics and torque feedback electronics
- Unique handle design results in perfect hand position with 15 degree tilt for fatigue-free operation
- Rubber grip for maximum comfort
- Torque feedback function maintains maximum torque at any speed
- Changing speed without leaving the handles is easy with the speed adjustor thumb wheel
- Mixes at maximum efficiency with any kind of material

Model No.	T80930	T80931
Power Input	1,100W	1,300W
Voltage	230V~50Hz / 120V~60Hz	
Output (N-m)	13.18	14.7
Number of Gears	1	2
No Load Speed	250~700	150~400 / 250~700
Protection	Double Insulation / Class 2	
Coupling Thread	M14-20	
Mixing Paddle Max. Diameter	120mm	140mm
Electronic Speed Control	√	√

\* Mixing paddle not included

### T25760 Paint Mixer (Medium)

- Ideal for stirring paint when using a power tool
- 400mm hexagonal shaft
- 80mm diameter head

### T25761 Paint Mixer (Large)

- Ideal for stirring paint when using a power tool
- 600mm hexagonal shaft
- 100mm diameter head

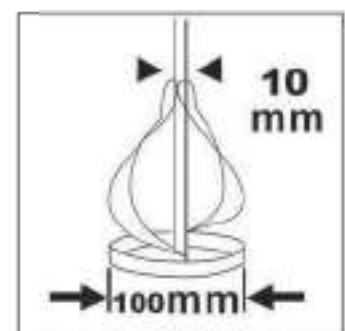
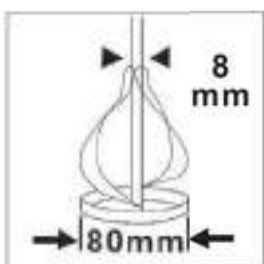



# Power Equipment







### T80900 1100w 19m Weldon Shank Auto-Reverse Tapping & Core Drill Machine

- Fully Mechanical tapping with automatic reversing controlled by crank motion
- Two-mode gear-box: one mode for auto-reverse tapping and one mode for annular cutters and twist drills
- Quick-release spindle for fast, tool-free switching of accessories

Motor	230V~50Hz / 120V~60Hz
Power	1100W
Annular Cutter Arbor	Set Screw Type, 19mm Weldon Shank
Annular Cutters	Dia. 35mm (1-3/8")
Taps	20mm (13/16")
Twist Drills	13mm (1/2")
Effective Stroke	150mm (6")
Magnetic Ashesion	15,000N (3,372 lb-f)
Drilling Mode No / Full Load	550 / 330 rpm
Tapping & Twist Drill Mode No / Full Load	150 / 90 rpm

#### Standard Accessories

- 5 Tap Collet Arbors in Sizes: M12, M14, M16, M18 & M20 (DIN 376 )
- Annular Cutter Arbor
- 3/4" (19mm) Weldon Shank
- 2.5mm L-Hex Key
- 4mm L-Hex Key
- Coolant Tank Kit
- Safety Chain

#### Optional Accessories

- Other Tap Collet Arbors



### T80903 1100W 1-Speed Magnetic Drilling Machine

Power Input	1100W	
No / Full Load RPM	620 / 350min	
Max. Capacity	Dia. x Depth of Cut	35mm x 50mm
	Dia. x Depth of Twist Drill Bit	13mm x 110mm
	Dia. x Depth of Taps	NA
Magnetic Ashesion	15,000N	

#### Standard Accessories:

- Wrench M8
- Hex Key M2.5
- Hex Key M4
- Chip Guard Kit
- Coolant Tank Kit
- Safety Chain

#### Optional Accessories:

- Chuck Adaptor
- 13mm Chuck & Key

**T80904 1800W 2-Speed Magnetic Drilling Machine**

Power Input	1800W	
No / Full Load	Speed 1	500 / 300rpm
	Speed 2	500 / 300rpm
Max. Capacity	Dia. x Depth of Cut	50mm x 75mm
	Dia. x Depth of Twist Drill Bit	16mm x 110mm
	Dia. x Depth of Taps	NA
Magnetic Adhesion	32,000N	

**Standard Accessories:**

- Wrench M8
- Hex Key M2.5
- Hex Key M4
- Chip Guard Kit
- Coolant Tank Kit
- Safety Chain

**Optional Accessories:**

- Chuck Adaptor
- 16mm Chuck & Key

**T80952 1100W Diamond Core Drilling Machine (Industrial Series)**

- Can drill at any angle from 0 to 45 degrees
- Can be anchored for use with up to 120mm bits
- High motor output for faster drilling
- Top quality sealed ball bearing construction for long tool life

Power Input	1100W
Voltage	230V~50Hz / 120V~60Hz
No Load Speed	1,000rpm
Capacity	Bit Diameter: 27mm (1") ~ 120mm (4-11/16")
	Effective Stroke: 350mm (13-13/16")
Angle	0°~45°
Arbor Thread	1-1/4"-7 UNC

**Standard Accessories:**

- Square Washer 3/8"
- Screw 3/8"x75mm
- Hex Nut 3/8"
- Driving Holder 3/8"
- Water Collector
- Wrench 14 x 17mm
- Wrench 27mm
- Wrench 32mm
- Anchor 3/8"







### T80386 1200W Wet / Dry Vacuum Dust Extractor

- Features integrated switching for tools up to 2200W without the need to turn the machine on or off manually
- 25 liter tank capacity
- High-output 1200W motor with high suction power ensures dust-free operation
- Long-life motor avoids over heating to even withstand the most challenging conditions
- Fully-automatic electromagnetic filter shaker for convenient, uninterrupted use
- Powerful electric blower function
- Optional pneumatic switching similar to the integrated switching above for electric tools



Power Input	1200W
Max. Airflow	4,000L/min (141.3CFM)
Max. Suction (Lift)	25 kPa (250 mbar) (100.4 inches of water)
Max. Dust Capacity	25L (6.6 gallons)
Max. Connected Power Tool	2200W
Weight	12.9kg (28.4 lbs)

### T80937 1400W Concrete Vibrator

- Light, dependable vibrator designed to remove bubbles from poured concrete
- Comfortable for the operator with the support strap
- Easy to use quickly under all conditions



Voltage	230V~50Hz / 120V~60Hz
No Load Speed	16,000rpm
Power Input	1400W
Vibration Rate	11,000B/min
Applicable Vibrator Shaft Types	AZ013, AZ014, AZ015 AZ017, AZ018, AZ019
Soft Start	With
Net Weight (Motor Head Only)	4.3kg (9.5 lbs)

**T80300 850W Digital Inverter Generator  
(230V, 50Hz)**

## • For Engine:

Engine Form	Single Cylinder, 4-Stroke, OHV, Gasline Engine
Displacement	53.5ml
Recommended Power	1.45kw
Ignition System	T.C.I
Starting System	Recoil Starter
Noise Standard	54~59db(A) / 7m
Fuel Type	Automotive Unlead Gasline
Fuel Tank Capacity	2.9L
Fuel Consumption	550g/Kw/H
Engine Oil Type	SAE10W30 (Above CC Grade)
Continuous Operating Hour	3.5hr

## • For Generator:

Phase	Single
Maximum Output	1.05KVA
Rated Output	0.85KVA
Rated Voltage	230V
Voltage Regulation	≤±0.5%
Rated Frquency	50Hz
Frequency Fluctation	≤±1Hz
Rated Currency	3.7A
Dc Output Voltage x Currency	12V 5A
Wave Distortion	≤2.5%

- GS, CE, EUII Certificate

**T80310 850W Digital Inverter Generator  
(120V, 60Hz)**

## • For Engine:

Engine Form	Single Cylinder, 4-Stroke, OHV, Gasline Engine
Displacement	53.5ml
Recommended Power	1.45kw
Ignition System	T.C.I
Starting System	Recoil Starter
Noise Standard	54~59db(A) / 7m
Fuel Type	Automotive Unlead Gasline
Fuel Tank Capacity	2.9L
Fuel Consumption	550g/Kw/H
Engine Oil Type	SAE10W30 (Above CC Grade)
Continuous Operating Hour	3.5hr

## • For Generator:

Phase	Single
Maximum Output	1.05KVA
Rated Output	0.85KVA
Rated Voltage	120v
Voltage Regulation	≤±0.5%
Rated Frquency	60Hz
Frequency Fluctation	≤±1Hz
Rated Currency	7.1A
Dc Output Voltage x Currency	12V 5A
Wave Distortion	≤2.5%

- C-ETL ,EPA, CARB Certificate

**T80301 1600W Digital Inverter Generator (230V, 50Hz)**

## • For Engine:

Engine Form	Single Cylinder, 4-Stroke, OHC. Gasline Engine
Displacement	105.6ml
Recommended Power	2.2kw
Ignition System	T.C.I
Starting System	Recoil Starter
Noise Stardard	54~59db(A) / 7m
Fuel Type	Automotive Unleaded Gasoline
Fuel Tank Capacity	0.45L
Fuel Consumption	550g/Kw/H
Engine Oil Type	SAE10W30 (Above CC Grade)
Continuous Operating Hour	3.5hr

## • For Generator:

Phase	Single
Maximum Output	1.8KVA
Rated Output	1.6KVA
Rated Voltage	230V
Voltage Regulation	≤±0.5%
Rated Frquency	50Hz
Frequency Fluctation	≤±1Hz
Rated Currency	7A
Dc Output Voltage x Currency	12V 8.3A
Wave Distortion	≤2.5%

- GS, CE, EU11 Certificate

**T80311 1600W Digital Inverter Generator (120V, 60Hz)**

## • For Engine:

Engine Form	Single Cylinder, 4-Stroke, OHC. Gasline Engine
Displacement	105.6ml
Recommended Power	2.2kw
Ignition System	T.C.I
Starting System	Recoil Starter
Noise Stardard	54~59db(A) / 7m
Fuel Type	Automotive Unleaded Gasoline
Fuel Tank Capacity	0.45L
Fuel Consumption	550g/Kw/H
Engine Oil Type	SAE10W30 (Above CC Grade)
Continuous Operating Hour	3.5hr

## • For Generator:

Phase	Single
Maximum Output	1.8KVA
Rated Output	1.6KVA
Rated Voltage	120V
Voltage Regulation	≤±0.5%
Rated Frquency	60Hz
Frequency Fluctation	≤±1Hz
Rated Currency	13.3A
Dc Output Voltage x Currency	12V 8.3A
Wave Distortion	≤2.5%

- C-ETL, EPA, CARB Certificate

**T80302 2400W Digital Inverter Generator (230V, 50Hz)**

## • For Engine:

Engine Form	Single Cylinder, 4-Stock, air-cooled. OHC. Gasline Engine
Displacement	171ml
Recommended Power	3.3kw
Ignition System	T.C.I
Starting System	Recoil Starter
Noise Stardard	63~72db(A) / 7m
Fuel Type	Automotive Unleaded Gasoline
Fuel Tank Capacity	4.8L
Fuel Consumption	500g/Kw/H
Engine Oil Type	SAE10W30 (Above CC Grade)
Continuous Operating Hour	3.3hr

## • For Generator:

Phase	Single
Maximum Output	2.9KVA
Rated Output	2.4KVA
Rated Voltage	230V
Voltage Regulation	≤±0.5%
Rated Frquency	50Hz
Frequency Fluctation	≤±1%
Rated Currency	10.4A
Dc Output Voltage x Currency	12V 8.3A
Wave Distortion	≤2.5%

- GS, CE, EUII Certificate

**T80312 2400W Digital Inverter Generator (120V, 60Hz)**

## • For Engine:

Engine Form	Single Cylinder, 4-Stock, air-cooled. OHC. Gasline Engine
Displacement	171ml
Recommended Power	3.3kw
Ignition System	T.C.I
Starting System	Recoil Starter
Noise Stardard	63~72db(A) / 7m
Fuel Type	Automotive Unleaded Gasoline
Fuel Tank Capacity	4.8L
Fuel Consumption	500g/Kw/H
Engine Oil Type	SAE10W30 (Above CC Grade)
Continuous Operating Hour	3.3hr

## • For Generator:

Phase	Single
Maximum Output	2.9KVA
Rated Output	2.4KVA
Rated Voltage	120V
Voltage Regulation	≤±0.5%
Rated Frquency	60Hz
Frequency Fluctation	≤±1%
Rated Currency	20.0A
Dc Output Voltage x Currency	12V 8.3A
Wave Distortion	≤2.5%

- C-ETL, EPA, CARB Certificate





### T80320 3000W Gasoline Generator (230V, 50Hz)

Engine Type	Air-Cooled Single-Cylinder 4-Stroke OHV
Displacement	196ml
Max.Power Output	4.8kw / 3,600rpm
Ignition System	Non-Contact Transistorized Magneto(TCI)
Starting System	Recoil / Electric
Recommend Power	4.0kw / 3,600rpm
Fuel Tank Capacity	15L
Fuel Consumption	1.13L/hr
Continuous Operating Hour	13hr
Oil Capacity	0.6L
Noise (7-Meter Away)	75dB
Rated Output Frequency	50Hz
Rated Output Voltage	230V
Rated Power Output	3.0KW

- GS, EUII Certificate

### T80334 3500W Gasoline Generator (120V, 60Hz)

Engine Type	Air-Cooled Single-Cylinder 4-Stroke OHV
Displacement	196ml
Max.Power Output	4.8kw / 3,600rpm
Ignition System	Non-Contact Transistorized Magneto(TCI)
Starting System	Recoil / Electric
Recommend Power	4.0kw / 3,600rpm
Fuel Tank Capacity	15L
Fuel Consumption	1.13L/hr
Continuous Operating Hour	13hr
Oil Capacity	0.6L
Noise (7-Meter Away)	75dB
Rated Output Frequency	60Hz
Rated Output Voltage	120V
Rated Power Output	3.5KW

- EPA Certificate

**T80321 6000W Gasoline Generator  
(230V, 50Hz)**

Engine Type	Air-Cooled Single-Cylinder 4-Stroke OHV
Displacement	389ml
Max.Power Output	9.5kw / 3,600rpm
Ignition System	Non-Contact Transistorized Magneto (TCI)
Starting System	Recoil / Electric
Recommend Power	8.2kw / 3,600rpm
Fuel Tank Capacity	25L
Fuel Consumption	2.7L/Hr
Continuous Operating Hour	9hr
Oil Capacity	1.1L
Noise (7-Meter Away)	74dB
Rated Output Frequency	50Hz
Rated Output Voltage	230V
Rated Power Output	6.0kw

- GS, EUII Certificate

**T80335 6500W Gasoline Generator  
(120V, 60Hz)**

Engine Type	Air-Cooled Single-Cylinder 4-Stroke OHV
Displacement	389ml
Max.Power Output	9.5kw / 3,600rpm
Ignition System	Non-Contact Transistorized Magneto (TCI)
Starting System	Recoil / Electric
Recommend Power	8.2kw / 3,600rpm
Fuel Tank Capacity	25L
Fuel Consumption	2.7L/Hr
Continuous Operating Hour	9hr
Oil Capacity	1.1L
Noise (7-Meter Away)	74dB
Rated Output Frequency	60Hz
Rated Output Voltage	120V
Rated Power Output	6.5kw

- EPA Certificate



### T80322 7000W Gasoline Generator (230V, 50Hz)

Engine Type	Air-Cooled Single-Cylinder 4-Stroke OHV
Displacement	389ml
Max. Power	11.8 Kw / 3,600 rpm
Ignition System	Non-Contact Transistorized Magneto (TCI)
Starting System	Recoil / Electric
Recommended Power	7kw / 3,600rpm
Fuel Tank Capacity	2.5L
Fuel Consumption	2.7L/hr
Continuous Operating Hour	8.5hr
Oil Capacity	1.1L
Noise (7-Meter Away)	75dB
Rated Frequency	50Hz
Rated Voltage	230V
Rated Output	7.0KW

- GS EU11 Certificate

### T80336 7500W Gasoline Generator (120V, 60Hz)

Engine Type	Air-Cooled Single-Cylinder 4-Stroke OHV
Displacement	389ml
Max. Power	11.8 Kw / 3,600 rpm
Ignition System	Non-Contact Transistorized Magneto (TCI)
Starting System	Recoil / Electric
Recommended Power	7kw / 3,600rpm
Fuel Tank Capacity	2.5L
Fuel Consumption	2.7L/hr
Continuous Operating Hour	8.5hr
Oil Capacity	1.1L
Noise (7-Meter Away)	75dB
Rated Frequency	60Hz
Rated Voltage	120V
Rated Output	7.5KW

- EPA Certificate

**T80325 140A Gasoline Welding Generator  
(230V, 50Hz)**

Engine Type	Single-Cylinder 4-Stroke, 25° inclined OHV air-cooled
Bore X Stroke	88mm x 64mm
Displacement	389ml
Max. Power Output	9.2kw / 3,600rpm
Compression Ratio	8.0 : 1
Ignition System	Non-contact Transistorized Magneto (TCI)
Start System	Recoil / Electric
Fuel Tank Capacity	17L
Spark Plug	F6RTC
Oil Capacity	1.1L
Phase	Single Phase
Rated Output Voltage	230V / 50Hz
Rated Power Output	2.0KW
Rated Voltage	26V
Rated Current	140A
Rated Output	3.64KW
Current Adjusting Range	50-190A
Rated Loading Continuity	50%
Welding Rod Diameter	2.0-5.0mm

- GS, EUII Certificate

**T80338 140A Gasoline Welding Generator  
(120V, 60Hz)**

Engine Type	Single-Cylinder 4-Stroke, 25° inclined OHV air-cooled
Bore X Stroke	88mm x 64mm
Displacement	389ml
Max. Power Output	9.2kw / 3,600rpm
Compression Ratio	8.0 : 1
Ignition System	Non-contact Transistorized Magneto (TCI)
Start System	Recoil / Electric
Fuel Tank Capacity	17L
Spark Plug	F6RTC
Oil Capacity	1.1L
Phase	Single Phase
Rated Output Voltage	120V / 60Hz
Rated Power Output	2.0KW
Rated Voltage	26V
Rated Current	140A
Rated Output	3.64KW
Current Adjusting Range	50-190A
Rated Loading Continuity	50%
Welding Rod Diameter	2.0-5.0mm

- EPA Certificate





### T80360 1-1/2" Two-Impeller Centrifugal Pump (Gasoline Engine)

Engine Type	Air-Cooled Single-Cylinder 4-Stroke 25° OHV
Displacement	163cc
Bore x Stroke	Ø68mm x 54mm
Max. Power	6.5Hp
Max. Torque	10N.m (2,500rpm)
Ignition System	Non-Contact Transistorized Ignition
Starting System	Recoil Hand Operated
Recommended Power	3.4kw / 3,600rpm
Fuel Tank Capacity	3.6L
Fuel Consumption	395g/kw.hr
Continuous Operating	3.5hrs (under 50% rated output)
Oil Capacity	0.6L
Outlet Size	Ø40mm (1-1/2")
Inlet Size	Ø40mm (1-1/2")
Max. Flow	12m³/h
Max. Head	75m
Max. Suction Head	7m
Max. Self-Priming Time	180s/4m
Speed	3,600rpm
Efficiency	38%
Noise (7-Meter Away)	85dB

- GS, CE Certificate

### T80361 2" Centrifugal Pump (Gasoline Engine )

Engine Type	Air-Cooled Single-Cylinder 4-Stroke 25°
Displacement	196cc
Bore x Stroke	Ø68mm x 54mm
Max. Power	6.5Hp
Max. Torque	11N.m (2,500rpm)
Ignition System	Non-Contact Transistorized Ignition
Starting System	Recoil Hand Operated
Recommended Power	4.0kw / 3,600rpm
Fuel Tank Capacity	3.6L
Fuel Consumption	395g/kw.hr
Continuous Operating	3.5hrs (under 50% rated output)
Oil Capacity	0.6L
Outlet Size	Ø50mm (2")
Inlet Size	Ø50mm (2")
Max. Flow	30m³/h
Max. Head	65m
Max. Suction Head	7m
Max. Self-Priming Time	180s/4m
Speed	3,600rpm
Efficiency	38%
Noise (7-Meter Away)	85dB

- GS, CE Certificate

**T80365 2" Centrifugal Pump (Gasoline Engine)**

Engine Type	Air-Cooled Single-Cylinder 4-Stroke OHV
Displacement	196cc
Bore x Stroke	Ø68mm x 54mm
Max. Power	6.5Hp
Max. Torque	10.5N.m (2,500rpm)
Ignition System	Non-Contact Transistorized Ignition
Starting System	Recoil Hand Operated
Recommended Power	4.0kw / 3,600rpm
Fuel Tank Capacity	3.8L
Fuel Consumption	395g/kw.hr
Continuous Operating	4Hr
Oil Capacity	0.6L
Outlet Size	Ø50mm (2")
Inlet Size	Ø50mm (2")
Max. Flow	25m <sup>3</sup> /h
Max. Head	26m
Max. Suction Head	6m
Max. Self-Priming Time	180s/m
Speed	3,600rpm
Efficiency	48%
Noise (7-Meter Away)	106dB

- GS, CE Certificate

**T80366 3" Centrifugal Pump (Gasoline Engine)**

Engine Type	Air-Cooled Single-Cylinder 4-Stroke OHV
Displacement	196cc
Bore x Stroke	Ø68mm x 54mm
Max. Power	6.5Hp
Max. Torque	10.5N.m (2,500rpm)
Ignition System	Non-Contact Transistorized Ignition
Starting System	Recoil Hand Operated
Recommended Power	4.0kw / 3,600rpm
Fuel Tank Capacity	3.8L
Fuel Consumption	395g/kw.hr
Continuous Operating	4Hr
Oil Capacity	0.6L
Outlet Size	Ø76.2mm (3")
Inlet Size	Ø76.2mm (3")
Max. Flow	48m <sup>3</sup> /h
Max. Head	30m
Max. Suction Head	6m
Max. Self-Priming Time	160s/m
Speed	3,600rpm
Efficiency	48%
Noise (7-Meter Away)	108dB

- GS, CE Certificate



### Electric Pressure Washer

- Four poles electric motor for overload protection
- 8m high-pressure hose
- Quick connect nozzles 0°, 15°, 40° and chemical nozzle
- Pressure adjustable
- Low pressure detergent injector
- Professional trigger gun with safety lock
- In-line water filter
- Electric wire with plug
- Pressure gauge
- Super strong plastic ABS machine shell



Model	<b>T81291</b>	<b>T81290</b>
Rated Pressure	1,450PSI / 100bar	1,250PSI / 86bar
Flow	3.3GPM / 12.5L/min.	1.2GPM / 4.5L/min.
Power	3.0KW 380V / 50Hz	2.2KW 230V / 50Hz
Speed	1,450rpm	1,450rpm

### Electric Pressure Washer

- Performance-approved electromotor with aluminium casing
- Commercial grade direct drive brass cylinder ceramic plungers radial direction pump
- 8m high-pressure hose
- Quick connect nozzles 0°, 15°, 40° and chemical nozzle
- Pressure adjustable
- Low pressure detergent injector
- Professional trigger gun with safety lock
- 10-inch pneumatic wheels
- In-line water filter
- Convenient hose and gun hook



Model	<b>T81302</b>	<b>T81303</b>
Rated Pressure	2,000PSI / 138bar	2,600PSI / 180bar
Flow	2.0GPM / 7.5L/min.	2.5GPM / 9.5L/min.
Power	4kw	5.5kw
Speed	1,450rpm	2,800rpm



### T81300 Electric Pressure Washer

- Performance-approved electromotor with aluminium casing
- 8m high-pressure hose
- Low pressure detergent injector
- Professional trigger gun with safety lock
- In-line water filter
- Electric wire with plug

Rated Pressure	1,450PSI / 100bar
Flow	1.6GPM / 6L/min.
Power	1.8KW
Speed	2,800rpm



### T81307 Electric Pressure Washer

- Performance-approved electricmotor with aluminium casing
- 8m high-pressure hose
- Pressure adjustable
- Low pressure detergent injector
- Professional trigger gun with safety lock
- In-line water filter
- Electric wire with plug
- Pressure gauge

Rated Pressure	1,550PSI / 106bar
Flow	1.6GPM / 6L/min.
Power	2.2KW
Speed	2,800rpm



### T81311 Gasoline Pressure Washer

- Performance-approved OHV engine with low oil protection
- 8m high-pressure hose
- Quick connect nozzles 0°, 25°, 40° and chemical nozzle
- Low pressure detergent injector
- Professional trigger gun with safety lock
- 10-inch pneumatic wheels
- In-line water filter
- Convenient hose and gun hook
- Thermal relief valve
- CE, EU II, EPA Approved

Rated Pressure	2,200PSI / 151bar
Flow	2.0GPM / 7.5L/min.
Power	5.5HP
Speed	3,400rpm





### T81310 Gasoline Pressure Washer

- Performance-approved OHV engine with low oil protection
- 8m high-pressure hose
- Quick connect nozzles 0°, 25°, 40° and chemical nozzle
- Low pressure detergent injector
- Professional trigger gun with safety lock
- 8, 10 or 12-inch pneumatic wheels
- In-line water filter
- Convenient hose and gun hook
- Thermal relief valve
- CE, EU11, EPA Approved

Rated Pressure	1,900PSI / 130bar
Flow	1.75GPM / 6.65L/min.
Power	5.5HP
Speed	3,400rpm



### T81312 Gasoline Pressure Washer

- Performance-approved OHV engine with low oil protection
- Commercial grade direct drive brass cylinder ceramic plungers radial direction pump
- 8m high-pressure hose
- Quick connect nozzles 0°, 15°, 25°, 40° and chemical nozzle
- Pressure adjustable
- Low pressure detergent injector
- Professional trigger gun with safety lock
- 10-inch pneumatic wheels
- In-line water filter
- Convenient hose and gun hook
- CE, EU11, EPA Approved

Rated Pressure	3,000PSI / 206bar
Flow	3.4GPM / 13L/min.
Power	13HP
Speed	3,400rpm



### T81313 Diesel Pressure Washer

- Performance-approved OHV engine
- Commercial grade direct drive brass cylinder ceramic plungers radial direction pump
- 8m high-pressure hose
- Quick connect nozzles 0°, 15°, 25°, 40° and chemical nozzle
- Pressure adjustable
- Low pressure detergent injector
- Professional trigger gun with safety lock
- 10-inch pneumatic wheels
- In-line water filter
- Convenient hose and gun hook
- CE, EPA Approved

Rated Pressure	3,000PSI / 206bar
Flow	2.1GPM / 8L/min.
Power	10HP
Speed	3,000rpm



## Cup Wire Brushes

- Brass Plated Steel

Model	Size (mm)	Dia.	Max. RPM
<b>T12839</b>	60	M14 x 2	12500
<b>T12840</b>	75	M14 x 2	12500
<b>T12841</b>	100	M14 x 2	8500
<b>T12842</b>	125	M14 x 2	6500
<b>T12843</b>	150	M14 x 2	6500



## Bevel Wire Wheel Brushes

- Brass Plated Steel

Model	Size (mm)	Dia.	Max. RPM
<b>T12885</b>	100	M14 x 2	12500
<b>T12886</b>	115	M14 x 2	12500



## Wire Wheel Brushes

- Brass Plated Steel

Model	Size (mm)	Dia. (mm)	Max. RPM
<b>T12910</b>	75	75 x 12.7	4500
<b>T12911</b>	100	100 x 12.7	4500
<b>T12907</b>	200	200 x 32	4500
<b>T12905</b>	125	125 x 20	8500
<b>T12906</b>	150	150 x 20	6500



## Cup Wire Brushes

- Brass Plated Steel

Model	Size (mm)	Dia. (mm)	Max. RPM
<b>T12849</b>	38	6	4500
<b>T12850</b>	50	6	4500
<b>T12851</b>	75	6	4500
<b>T12852</b>	80	6	4500
<b>T12854</b>	38	6	12000
<b>T12855</b>	50	6	12000
<b>T12856</b>	75	6	12000



## Extra Thick Wire Wheel Brushes

Model	Size (mm)	Dia. (mm)	Max. RPM
<b>T12923</b>	50	6	4500
<b>T12924</b>	75	6	4500
<b>T12925</b>	100	6	4500





### Wire Wheel Brushes

- Brass Plated Steel

Model	Size (mm)	Dia. (mm)	Max. RPM
<b>T12914</b>	38mm	6	4500
<b>T12915</b>	50mm	6	4500
<b>T12916</b>	75mm	6	4500
<b>T12917</b>	100mm	6	4500
<b>T12918</b>	38mm	6	20000
<b>T12919</b>	50mm	6	20000
<b>T12920</b>	75mm	6	20000
<b>T12921</b>	100mm	6	20000



### End Wire Brushes

- Brass Plated Steel

Model	Size (mm)	Dia. (mm)	Max. RPM
<b>T12946</b>	17	6	4500
<b>T12948</b>	24	6	4500
<b>T12950</b>	25	6	4500
<b>T12952</b>	30	6	4500
<b>T12945</b>	12	6	20000
<b>T12947</b>	17	6	20000
<b>T12949</b>	24	6	20000
<b>T12951</b>	25	6	20000
<b>T12953</b>	30	6	20000



### Twisted Cup Wire Brushes

Model	Size (mm)	Dia.	Max. RPM
<b>T12860</b>	65	M14 x 2	12500
<b>T12861</b>	80	M14 x 2	12500
<b>T12862</b>	100	M14 x 2	8500



### Twisted Wire Wheel Brushes

Model	Size (mm)	Dia.	Max. RPM
<b>T12929</b>	100	M14 x 2	12500
<b>T12930</b>	115	M14 x 2	12500
<b>T12931</b>	125	M14 x 2	11000



### Bevel Wire Wheel Brushes

Model	Size (mm)	Dia.	Max. RPM
<b>T12880</b>	100	M14 x 2	12500
<b>T12881</b>	115	M14 x 2	12500

## Silicon Carbide Bevel Brush

Model	Size (mm)	Dia.	Max. RPM
<b>T12895</b>	100	M14	12500



## Silicon Carbide Bevel Brush

Model	Size (mm)	Dia. (mm)	Max. RPM
<b>T12900</b>	100	6	12500



## Non-Woven Bevel Brush

Model	Size (mm)	Dia.	Max. RPM
<b>T12890</b>	100	M14	8500



## Nylon Cup Brushes

Model	Size (mm)	Dia. (mm)	Max. RPM
<b>T12870</b>	50	6	4500
<b>T12871</b>	75	6	4500



## Nylon Wheel Brushes

Model	Size (mm)	Dia. (mm)	Max. RPM
<b>T12940</b>	75	6	4500
<b>T12941</b>	100	6	4500



## T12960 4pc Wire Brush Set

- Contents:
  - 1 - 50mm Wheel Brush
  - 1 - 50mm Cup Brush
  - 1 - 24mm End Brush
  - 1 - Quick Connector







### High Speed Steel Drill Bits

- 9341 High speed drill
- Great for general drilling into wood, metal and plastic
- Speed helix penetrates 3 times faster
- 135 Degree split point tip for accurate starts without walking



Model	Size	Model	Size
T50040	1mm	T50108	5.8mm
T50044	1.2mm	T50110	6mm
T50050	1.5mm	T50112	6.2mm
T50060	2mm	T50115	6.5mm
T50064	2.2mm	T50120	7mm
T50070	2.5mm	T50125	7.5mm
T50076	2.8mm	T50130	8mm
T50080	3mm	T50135	8.5mm
T50082	3.2mm	T50140	9mm
T50087	3.7mm	T50145	9.5mm
T50088	3.8mm	T50150	10mm
T50090	4mm	T50155	10.5mm
T50092	4.2mm	T50160	11mm
T50095	4.5mm	T50165	11.5mm
T50098	4.8mm	T50170	12mm
T50100	5mm	T50175	12.5mm
T50102	5.2mm	T50180	13mm
T50105	5.5mm		

### Masonry Drill Bits

- Carbide tip provides up to 2 times longer life
- Innovative tip configuration reduces walking for improved accuracy



Model	Size	Model	Size
T50250	3mm	T50265	11mm
T50252	4mm	T50266	12mm
T50254	5mm	T50268	14mm
T50256	6mm	T50269	15mm
T50258	7mm	T50270	16mm
T50260	8mm	T50272	18mm
T50262	9mm	T50274	20mm
T50264	10mm		

### SDS Hammer Drill Bits

- 40 Cr steel drill
- Tungsten carbide tip



Model	Size	Model	Size	Model	Size
T50350	3 x 110mm	T50382	8 x 260mm	T50463	15 x 160mm
T50352	3.5 x 110mm	T50383	8 x 310mm	T50474	16 x 160mm
T50353	3.5 x 160mm	T50386	8 x 450mm	T50475	16 x 210mm
T50354	4 x 110mm	T50388	8 x 600mm	T50476	16 x 260mm
T50355	4 x 160mm	T50392	9 x 160mm	T50477	16 x 310mm
T50356	5 x 110mm	T50393	9 x 210mm	T50480	16 x 450mm
T50357	5 x 160mm	T50403	10 x 110mm	T50482	16 x 600mm
T50358	5 x 210mm	T50404	10 x 160mm	T50497	18 x 210mm
T50359	5.5 x 110mm	T50405	10 x 210mm	T50498	18 x 260mm
T50360	5.5 x 160mm	T50406	10 x 260mm	T50499	18 x 310mm
T50361	5.5 x 210mm	T50407	10 x 310mm	T50502	18 x 450mm
T50362	5.5 x 260mm	T50410	10 x 450mm	T50504	18 x 600mm
T50363	5.5 x 310mm	T50412	10 x 600mm	T50510	19 x 310mm
T50364	6 x 110mm	T50416	11 x 160mm	T50513	19 x 450mm
T50365	6 x 160mm	T50418	11 x 260mm	T50519	20 x 210mm
T50366	6 x 210mm	T50419	11 x 310mm	T50520	20 x 260mm
T50367	6 x 260mm	T50428	12 x 160mm	T50521	20 x 310mm
T50368	6 x 310mm	T50429	12 x 210mm	T50524	20 x 450mm
T50369	6 x 450mm	T50430	12 x 260mm	T50526	20 x 600mm
T50370	6.5 x 110mm	T50431	12 x 310mm	T50542	22 x 260mm
T50371	6.5 x 160mm	T50434	12 x 310mm	T50543	22 x 310mm
T50372	6.5 x 210mm	T50436	12 x 450mm	T50546	22 x 450mm
T50373	6.5 x 260mm	T50440	12 x 600mm	T50548	22 x 600mm
T50374	6.5 x 310mm	T50442	13 x 160mm	T50568	24 x 450mm
T50375	7 x 110mm	T50444	13 x 260mm	T50575	25 x 260mm
T50376	7 x 160mm	T50446	14 x 160mm	T50576	25 x 310mm
T50377	7 x 210mm	T50448	14 x 210mm	T50579	25 x 450mm
T50379	8 x 110mm	T50452	14 x 260mm	T50581	25 x 600mm
T50380	8 x 160mm	T50455	14 x 310mm		
T50381	8 x 210mm	T50458	14 x 450mm		
		T50460	14 x 600mm		

## SDS Chisel

- Heated-treated blade for extra toughness and strength
- Used in concrete, brick and other similar materials
- Blade made of 40 Cr

**T50850** 250mm SDS Chisel Point

**T50851** 22 x 250mm SDS Chisel

**T50852** 25 x 250mm SDS Gouge Chisel



## Wood Flat Drills

- 40 Cr steel
- Maximum life cutting corners for longer life in nails
- Heavy duty shank for superior durability



Model	Size	Length	Model	Size	Length
<b>T51000</b>	6mm	150mm	<b>T51012</b>	20mm	150mm
<b>T51001</b>	7mm	150mm	<b>T51013</b>	22mm	150mm
<b>T51002</b>	8mm	150mm	<b>T51015</b>	25mm	150mm
<b>T51003</b>	9mm	150mm	<b>T51016</b>	28mm	150mm
<b>T51004</b>	10mm	150mm	<b>T51017</b>	32mm	150mm
<b>T51005</b>	11mm	150mm	<b>T51030</b>	6mm	300mm
<b>T51006</b>	12mm	150mm	<b>T51031</b>	8mm	300mm
<b>T51008</b>	14mm	150mm	<b>T51032</b>	10mm	300mm
<b>T51009</b>	16mm	150mm	<b>T51033</b>	12mm	300mm
<b>T51010</b>	18mm	150mm	<b>T51034</b>	16mm	300mm

## Step Drill

- High quality M2 high speed steel material
- Titanium plated for long using life



Model	Size	Model	Size
<b>T51410</b>	4 - 12mm	<b>T51413</b>	6 - 20mm
<b>T51411</b>	4 - 20mm	<b>T51414</b>	6 - 30mm
<b>T51412</b>	6 - 18mm	<b>T51415</b>	8 - 35mm

## Zirconium High Speed Steel Drill Bit Sets



- Zirconium nitride coated for extra strength
- 135 Degree Heavy-duty split-point & grooved allows precise drilling
- Provides faster penetration with less force
- Ideal for industrial uses on metal, drywall, plastic & wood applications

**T17001** 14pc High Speed Steel Drill Bit Set (SAE)

1/16" (2pc), 5/64", 3/32", 7/64", 1/8" (2pc),  
9/64", 5/32", 3/16", 7/32", 1/4", 5/16", 3/8"

**T17002** 14pc High Speed Steel Drill Bit Set (Metric)

1.5 (2pc), 2, 2.5, 3, 3.2 (2pc), 3.5, 4, 5, 6, 6.5, 8, 10mm



### T50232 16pc High Speed Steel Drill Bit Set w/ Quick-Release Shank

- 9341 High speed steel
- Great for general drilling into wood, metal and plastic
- Standard hex shank fits all power bit quick change chucks
- Contents:  
1/16", 5/64", 3/32", 7/64", 1/8", 9/64", 5/32", 11/64", 3/16", 13/64", 7/32", 15/64", 1/4", 5/16", 3/8", 1/2"



### T50235 19pc High Speed Steel Drill Bit Set

- 9341 High speed steel
- Great for general drilling into wood, metal and plastic
- Speed helix penetrates 3 times faster
- 135 Degree split point tip for accurate starts without walking
- Contents:  
1, 1.5, 2, 2.5, 3, 3.5, 4, 4.5, 5, 5.5, 6, 6.5, 7, 7.5, 8, 8.5, 9, 9.5, 10mm



### T17008 29pc High Speed Steel Drill Bit Set

- Contents:  
1/16", 5/64", 3/32", 7/64", 1/8", 9/64", 5/32", 11/64", 3/16", 13/64", 7/32", 15/64", 1/4", 17/64", 9/32", 19/64", 5/16", 21/64", 11/32", 23/64", 3/8", 25/64", 13/32", 27/64", 7/16", 29/64", 15/32", 31/64", 1/2"



### T50340 5pc Masonry Drill Bit Set

- Carbide tip provides up to 2 times longer life
- Innovative tip configuration reduces walking for improved accuracy
- Contents: 4, 5, 6, 8, 10mm



### T50860 5pc SDS Hammer Drill Bit Set

- Special shank design provides fast dust removal
- Carbide-tipped drill bit head is harder, tougher and more resistant to extreme loads
- Contents:  
5mm x 110mm, 6mm x 110mm,  
6mm x 160mm, 8mm x 160mm, 10mm x 160mm

### T50341 7pc Masonry Drill Bit Set

- Carbide tip provides up to 2 times longer life
- Innovative tip configuration reduces walking for improved accuracy
- Contents:  
4, 5, 6, 7, 8, 10, 12mm



### T50861 7pc SDS Hammer Drill Bit Set

- Special shank design provides fast dust removal
- Carbide-tipped drill bit head is harder, tougher and more resistant to extreme loads
- Contents:  
5 x 110mm, 6 x 110mm, 8 x 110mm,  
6 x 160mm, 8 x 160mm, 10 x 160mm, 12 x 160mm



### T51040 6pc Wood Flat Drill Set

- 40 Cr steel
- Maximum life cutting corners for longer life in nails
- Heavy duty shank for superior durability
- Contents: 10, 12, 16, 18, 20, 25mm



### T51425 3pc Step Drill Set

- High quality M2 high speed steel material
- Titanium plated for long using life
- Contents:  
4 - 12, 6 - 20, 6 - 30mm







### **T51397 7pc Auger Bit Set**

- High carbon steel
- Aluminum storage case
- Contents: 8, 10, 12, 14, 16, 18, 20 x 230mm



### **T33293 2pc Double-End Torque Control Bit Set (110mm)**

- S2 alloy steel
- Contents:
  - 2 - Phillips #1, #2 x #2, #3 (Pozi #1, #2 x #2, #3)



### **T33294 5pc Double-End Power Bit Set (65mm)**

- S2 alloy steel
- Magnetic ring secures fastener attachment
- Contents:
  - 5 - Phillips #1, #2 x #2, #3 (Pozi #1, #2 x #2, #3)

## Bi-Metal Hole Saw

- Manganese alloy steel body
- M3 high speed steel blade



Model	Size	Model	Size
T34001	16mm	T34035	76mm
T34003	19mm	T34037	83mm
T34005	22mm	T34038	86mm
T34008	25mm	T34039	89mm
T34010	29mm	T34040	92mm
T34012	32mm	T34041	95mm
T34014	35mm	T34042	98mm
T34016	38mm	T34043	102mm
T34018	41mm	T34044	105mm
T34020	44mm	T34045	108mm
T34023	51mm	T34046	111mm
T34025	54mm	T34047	114mm
T34026	57mm	T34048	121mm
T34028	60mm	T34049	127mm
T34029	64mm	T34050	133mm
T34031	67mm	T34051	140mm
T34033	70mm	T34052	146mm
T34034	73mm	T34053	152mm

## Tungsten Carbide Hole Saw

- Manganese alloy steel body
- Tungsten carbide tip



Model	Size	Model	Size
T34100	19mm	T34117	57mm
T34101	20mm	T34118	60mm
T34102	22mm	T34119	63mm
T34103	25mm	T34120	65mm
T34104	27mm	T34121	67mm
T34105	29mm	T34122	68mm
T34106	30mm	T34123	71mm
T34107	32mm	T34124	73mm
T34108	35mm	T34125	74mm
T34109	36mm	T34126	76mm
T34110	38mm	T34127	80mm
T34111	40mm	T34128	92mm
T34112	44mm	T34129	102mm
T34113	45mm	T34130	105mm
T34114	50mm	T34131	111mm
T34115	51mm	T34132	125mm
T34116	54mm	T34133	127mm

## Tungsten Grit Edged Hole Saw

- High carbon steel body
- Tungsten carbide grit edge



Model	Size	Model	Size
T34170	14mm	T34203	70mm
T34171	16mm	T34204	73mm
T34173	19mm	T34205	76mm
T34176	22mm	T34206	79mm
T34178	25mm	T34207	83mm
T34179	27mm	T34208	86mm
T34180	29mm	T34209	89mm
T34182	32mm	T34210	92mm
T34184	35mm	T34211	95mm
T34185	37mm	T34212	98mm
T34186	38mm	T34213	102mm
T34188	41mm	T34214	105mm
T34190	44mm	T34215	108mm
T34192	48mm	T34216	111mm
T34193	51mm	T34217	114mm
T34195	54mm	T34218	121mm
T34196	57mm	T34219	127mm
T34197	59mm	T34220	133mm
T34198	60mm	T34221	140mm
T34199	64mm	T34222	146mm
T34201	67mm	T34223	152mm
T34202	68mm		



### 3/8" Hex Shank Arbors

- Drill 9341 high speed steel material



Model	Size
<b>T34070</b>	3/8" - 1/2" - 20UNF

### Unf Arbors

- Drill 9341 high speed steel material



Model	Size
<b>T34240</b>	3/8" - 1/2" - 20UNF

### Hex Shank Arbors

- Drill 9341 high speed steel material



Model	Size
<b>T34071</b>	7/16" - 5/8" - 18UNF
<b>T34072</b>	3/8" - 5/8" - 18UNF

### Unf Arbors

- Drill 9341 high speed steel material



Model	Size
<b>T34241</b>	7/16" - 5/8" - 18UNF
<b>T34242</b>	3/8" - 5/8" - 18UNF

### T34150 7pc Tungsten Carbide Hole Saw Set



- Tungsten carbide tip
- Manganese alloy steel body
- Contents:
  - 5 - Hole Saws: 22, 25, 32, 38, 54mm
  - 1 - Arbor
  - 1 - Adaptor

### T34080 7pc Hole Saw Set



- Manganese alloy steel body
- M3 high speed steel blade
- Contents:
  - 5 - Hole Saws: 22, 25, 32, 38, 54mm
  - 1 - Arbor
  - 1 - Adaptor



### T34151 9PC Tungsten Carbide Hole Saw Set

- Tungsten carbide tip
- Manganese alloy steel body
- Contents:
  - 6 - Hole Saws: 7/8" (22mm), 1-1/8" (29mm), 1-3/8" (35mm), 1-3/4" (44mm), 2" (51mm), 2-1/2" (64mm)
  - 2 - Arbors
  - 1 - Adaptor

## T17101 9pc Hole Saw Kit

- Cuts various wood, plastic, or metal materials
- M3 high speed steel cutting edge for fast and accurate cuts
- Heat-treated, bi-metal steel assembly for superior durability
- 6 Most common saw sizes for electrical installation
- Contents:
  - 6 - Hole Saws:
    - 7/8" (22mm), 1-1/8" (29mm), 1-3/8" (35mm),
    - 1-3/4" (44mm), 2" (51mm), 2-1/2" (64mm)
  - 2 - Arbors
  - 1 - Adaptor



## T34250 7pc Tungsten Grit Edged Hole Saw

- High carbon steel body
- Tungsten carbide grit edge
- Contents:
  - 5 - Hole Saws: 22, 25, 32, 38, 54mm
  - 1 - Arbor
  - 1 - Adaptor



## T34251 8pc Tungsten Grit Edged Hole Saw

- High carbon steel body
- Tungsten carbide grit edge
- Contents:
  - 6 - Hole Saws: 19, 22, 29, 39, 44, 57mm
  - 2 - Arbors



## T17104 8pc Carbide Coated Hole Saw Kit

- Cuts clean, smooth, and accurate holes in ceramics, bricks, hardwoods, concrete, composites, etc.
- Resistant to heat, wear and abrasion with shock resistant back
- Constructed of tungsten carbide grit cutting surfaces provides easy thorough hole drilling
- Contents:
  - 5 - Hole Saws: 33, 53, 67, 73, 83mm
  - 1 - 250mm Carbide Coated Half-Round File
  - 1 - Aluminum Plate
  - 1 - Masonry Drill







(Dry)

### Diamond Cutting Wheel

- Diamond consistency 28%
- Strength 18kg

Model	Dia. x Segment Width x Segment Height
T12502	105 x 19 x 7mm
T12504	115 x 20 x 7mm
T12505	125 x 22 x 7mm
T12506	150 x 22 x 7mm
T12507	180 x 24 x 7mm
T12509	230 x 26 x 7mm
T12511	300 x 30 x 7mm
T12512	350 x 30 x 7mm



(Wet)

Model	Dia. x Segment Width x Segment Height
T12522	105 x 19 x 7mm
T12524	115 x 20 x 7mm
T12525	125 x 22 x 7mm
T12526	150 x 22 x 7mm
T12527	180 x 24 x 7mm
T12529	230 x 26 x 7mm
T12531	300 x 30 x 7mm
T12532	350 x 30 x 7mm



(Turbo)

Model	Dia. x Segment Width x Segment Height
T12542	105 x 19 x 7mm
T12544	115 x 20 x 7mm
T12545	125 x 22 x 7mm
T12546	150 x 22 x 7mm
T12547	180 x 24 x 7mm
T12549	230 x 26 x 7mm
T12551	300 x 30 x 7mm
T12552	350 x 30 x 7mm

### Laser Diamond Cutting Wheel

- Diamond consistency 35%
- Strength 24kg



Model	Dia. x Segment Width x Segment Height
T12562	105 x 21 x 7.5mm
T12564	115 x 21 x 7.5mm
T12565	125 x 21 x 7.5mm
T12567	180 x 23 x 7.5mm
T12568	200 x 24 x 7.5mm
T12569	230 x 25 x 7.5mm
T12570	250 x 26 x 10mm
T12571	300 x 30 x 10mm
T12572	350 x 32 x 10mm
T12573	400 x 38 x 10mm
T12574	450 x 40 x 10mm
T12575	500 x 42 x 10mm



## Tungsten Carbide Saw Blades

- High carbon steel body
- Tungsten carbide tip

Model	Dia.	Teeth
<b>T12681</b>	255mm 10"	96
<b>T12683</b>	305mm 12"	96
<b>T12684</b>	305mm 12"	120
<b>T12685</b>	355mm 14"	96
<b>T12686</b>	355mm 14"	120



## Tungsten Carbide Saw Blades

- High carbon steel body
- Tungsten carbide tip

Model	Dia.	Teeth
<b>T12615</b>	180mm 7"	24
<b>T12616</b>	180mm 7"	40
<b>T12617</b>	180mm 7"	60
<b>T12619</b>	200mm 8"	40
<b>T12620</b>	200mm 8"	60
<b>T12623</b>	230mm 9"	40
<b>T12625</b>	230mm 9"	60
<b>T12629</b>	255mm 10"	56
<b>T12630</b>	255mm 10"	80
<b>T12635</b>	305mm 12"	56
<b>T12637</b>	305mm 12"	80
<b>T12641</b>	355mm 14"	56
<b>T12643</b>	355mm 14"	80





### 3pc Grinding Stones - Silicon Carbide



Model	Head Dia.	Shank Dia.	Length
<b>T35201</b>	7.1mm	3.2mm	38mm

### 3pc Grinding Stones - Silicon Carbide



Model	Head Dia.	Shank Dia.	Length
<b>T35200</b>	3.2mm	3.2mm	38mm

### 3pc Grinding Stones - Silicon Carbide



Model	Head Dia.	Shank Dia.	Length
<b>T35205</b>	3.2mm	3.2mm	38mm

### 3pc Grinding Stones - Silicon Carbide



Model	Head Dia.	Shank Dia.	Length
<b>T35206</b>	4.8mm	3.2mm	38mm

### 1pc Grinding Stone - Silicon Carbide



Model	Head Dia.	Shank Dia.	Length
<b>T35212</b>	19.8mm	3.2mm	38mm

### 1pc Grinding Stone - Silicon Carbide



Model	Head Dia.	Shank Dia.	Length
<b>T35210</b>	10.3mm	3.2mm	38mm

### 1pc Grinding Stone - Silicon Carbide



Model	Head Dia.	Shank Dia.	Length
<b>T35211</b>	12.7mm	3.2mm	38mm

### 3pc Grinding Stones - Silicon Carbide



Model	Head Dia.	Shank Dia.	Length
<b>T35216</b>	4.0mm	3.2mm	38mm

### 3pc Grinding Stones - Aluminum Oxide



Model	Head Dia.	Shank Dia.	Length
<b>T35230</b>	4.8mm	3.2mm	42mm

### 3pc Grinding Stones - Aluminum Oxide



Model	Head Dia.	Shank Dia.	Length
<b>T35231</b>	5.6mm	3.2mm	42mm



### 2pc Grinding Stones - Aluminum Oxide



Model	Head Dia.	Shank Dia.	Length
<b>T35235</b>	11.1mm	3.2mm	38mm

### 2pc Grinding Stones - Aluminum Oxide



Model	Head Dia.	Shank Dia.	Length
<b>T35236</b>	15.9mm	3.2mm	38mm

### 2pc Grinding Stones - Aluminum Oxide



Model	Head Dia.	Shank Dia.	Length
<b>T35237</b>	4.8mm	3.2mm	38mm

### 2pc Grinding Stones - Aluminum Oxide



Model	Head Dia.	Shank Dia.	Length
<b>T35238</b>	9.5mm	3.2mm	38mm

### 3pc Grinding Stones - Aluminum Oxide



Model	Head Dia.	Shank Dia.	Length
<b>T35239</b>	6.4mm	3.2mm	38mm

### 3pc Grinding Stones - Aluminum Oxide



Model	Head Dia.	Shank Dia.	Length
<b>T35220</b>	3.2mm	3.2mm	38mm

### 3pc Grinding Stones - Aluminum Oxide



Model	Head Dia.	Shank Dia.	Length
<b>T35225</b>	4.8mm	3.2mm	38mm

### 1pc Grinding Stones - Aluminum Oxide



Model	Head Dia.	Shank Dia.	Length
<b>T35228</b>	25.4mm	3.2mm	38mm

### 2pc Grinding Stones - Aluminum Oxide



Model	Head Dia.	Shank Dia.	Length
<b>T35226</b>	9.5mm	3.2mm	38mm

### 2pc Grinding Stones - Aluminum Oxide



Model	Head Dia.	Shank Dia.	Length
<b>T35227</b>	15.9mm	3.2mm	38mm





### T35252 400pc Rotary Tool Accessory & Assortment

- Contents:
  - 4 - Collet Chucks: 1.50, 2.35, 3.20mm (2pc) Diameter
  - 4 - Drill Bits: 1.50 (2pc), 2.35mm (2pc) Diameter
  - 1 - Polishing Wheel Shank
  - 4 - Big Fleece Polishing Wheels: 25 x 6mm
  - 1 - Big Cotton Polishing Wheel: 25 x 6mm
  - 6 - Small Fleece Polishing Buffs: 5 Wheels 13 x 6mm & 1 Dome
  - 2 - Rubber Polishing Wheels: 22 x 3mm
  - 5 - Diamond Points
  - 10 - Grinding Stones
  - 12 - Grinding Wheels:
    - 6 Coarse: 20 x 2.5mm, 6 fine: 20 x 2.5mm
  - 3 - Mandrels With Screw Top
  - 137 - Carborundum Cutting Wheels: 24 x 1mm Diameter
  - 30 - Carborundum Cutting Wheels: 24 x 0.6mm Diameter
  - 5 - Reinforced Carborundum Cutting Wheels: 32 x 1.3mm Diameter
  - 2 - Sanding Drum Mandrels
  - 12 - Sanding Drums:
    - 13 x 13mm diameter (8pc), 6 x 13mm Diameter (4pc)
  - 1 - Flap Sander - 80 Grit: 30 x 10mm
  - 150 - Sanding Discs: 24mm Diameter
  - 4 - Wire Brass & Steel Brushes: 2 Wheels, 2 Cups
  - 3 - Nylon Brushes: 2 Pencil, 1 Wheel
  - 2 - High Speed Steel Milling Cutters: 1 inverted cone, 1 ball 3mm
  - 1 - Sharpening Stone
  - 1 - Spanner / Screwdriver



### T35250 5pc Mounted Point Grinding Stone

- Material: aluminum oxide
- Contents:
  - 13.5 x 22 x 3.17mm, 13.5 x 20 x 3.17mm,
  - 12 x 14 x 3.17mm, 12 x 15 x 3.17mm,
  - 13 x 15 x 3.17mm



### T35258 6pc Chain Saw Sharpener Kit

- Use with rotary tools
- Includes guide attachment and 4 bits
  - 3/16" (4.8mm) Orange - 120 grit
  - 11/64" (4.5mm) White - 220 grit
  - 5/32" (4.0mm) Blue - 220 grit
  - 7/32" (5.5mm) Red - 120 grit



# Specialty Tools





## T71100 Battery Analyzer



- Compact, easy to use and fully portable
- Functions: alternator testing, battery testing and crank-motor testing
- Tests the condition of automotive battery using the conductance method
- Checks alternator's charging and engine starter conditions
- Large and easy to read LCD display
- Tests results based on JIS, EN, DIN, SAE & IEC standards
- Gets accurate results in milliseconds
- Use to test a wide range of 12V batteries

## T71101 Digital Battery / Charging / Starting System Analyzer w/ Printer



- Checks battery charging and starting system
- Multistandard to norm SAE, DIN, IEC, liquid or gel lead and battery state/starting power instantaneous analysis
- Test 6V, 12V batteries and charging system, multiple rating systems
- Test discharged batteries down to 1.5V
- Operating range: 40 - 2000 cca

## T71102 Digital Battery Load Test / Charging System Analyzer



- Microprocessor controlled design to guarantee an easy and accurate load test
- Automatically turns off the load after 10 seconds and latch the voltage
- For 12V battery system use only

## T71103 125 Amp Hand-held Battery Load Tester



- Applications: 6V, 12V sli, agm & gel batteries
- Capacity: true 125 amp load
- Operating range: up to 1000 cca
- Test battery:
  - a) state of charge
  - b) cranking ability
  - c) charging system
  - d) starter condition



### T71104 125 Amp Hand-held Battery Load Tester



- Applications: 12V sli, agm & gel batteries
- Capacity: true 125 amp load
- Operating range: up to 1000 cca
- Test battery:
  - a) state of charge.
  - b) cranking ability
  - c) charging system
  - d) starter condition.

### T71192 Current Leakage Catcher



- Check leakage location rapidly
- Only connect the power wire according to the colors
- Quick evaluation and response from the tester if the part is aged or crank

### T71146 Automotive Multimeter



- To solve and reset the car electrical problems
- Contents:
  - 1 - Mainframe
  - 1 - Inducted Hook
  - 1 - Thermal Covering Socket
  - 1 - Multi-Thermal Lead Red, Black Probe
  - 1 - Crashproof Rubber Jacket Manual
  - 1 - 8.9v Battery





### T71244 Ignition Expert Set



- To operate gasoline engine have to accompany with ignition system
- Mainframe power line
- Spark tester
- Leakage current
- Connected line of red, blue, green, black
- Operating manual, CD



### T75713 12 / 24V Battery Charger

- Portable bench charger
- Engine start assist capability
- Deep cycle charge
- Reverse connect protection
- Arc prevention technology



### T75717 6 / 12 / 24V Battery Charger

- Infinite / dual / single charge rate
- Engine start assist capability
- Reverse connect warning LED indicator
- Battery level percentage and voltage indicator charging status amp meter full charge led
- High torque resist two hour timer / hold function, industrial grade cable & clamp equipped

### T75714 Automatic Battery Charger and Starter

- Engine start assist capability
- Deep cycle charge
- Reverse connect protection
- Arc prevention technology





### T70002 1-1/16" Deep Oil Pressure Switch Socket

- Removes and installs 1-1/16" oil pressure, sending units up to 2-5/8" long
- Heat-treated, alloy steel
- Use with 3/8" square drive or 1-1/8" hex
- Fits most 1991 to current GM vehicles using oil pressure gauge and 1987 to current Chrysler with light and gauge



### T70004 1" & 1-1/16" Oil Pressure Switch Socket

- Removes and installs 1" and 1-1/16" oil pressure, sending units up to 1-5/8" long
- Heat-treated, alloy steel
- Use with 3/8" square drive
- Fits most small cars using an oil warning light



### T70005 1-3/16" Oil Pressure Sending Unit Socket

- Removes and installs 1-3/16" oil pressure, sending units up to 4-1/4" long
- Heat-treated, alloy steel
- Use with 3/8" square drive or 3/4" hex
- Fits most late model GM vehicles using oil gauge



### T70014 3/8" Dr. Offset Oxygen Sensor Wrench

- Removes and installs oxygen sensors on vehicles with computerized engine control
- Offset design for increased maneuverability
- 7/8" 6-pt socket with cutaway slot provides extra clearance for oxygen sensor wires



### T70015 Oxygen / Vacuum Sensor Switch Socket

- Removes and installs oxygen sensors and vacuum switches on computerized engine control vehicles
- 7/8" hex socket with cutaway slot provides extra clearance for oxygen sensor wires during installation
- Use with 3/8" square drive



### T75518 Compact Offset Oxygen Sensor Wrench

- Removes and installs oxygen sensors on vehicles with computerized engine control
- Offset design for increased maneuverability
- Features a 7/8" hex, 1/2" double square drive with cutaway slot providing extra clearance for oxygen sensor wires during installation



### T75787 3pc Oxygen Sensor Socket Set



- Includes:
  - T70014 - 3/8" Dr. Offset Oxygen Sensor Wrench
  - T70015 - Oxygen / Vacuum Sensor Switch Socket
  - T75518 - 1/2" Double Square Dr. Offset Oxygen Sensor Wrench

- Contains 3 most popular oxygen sensor and vacuum switch sockets
- Alloy steel, heat-treated for strength and durability
- Works on most computerized engine controlled vehicles



### T75771 7pc Oxygen Sensor Socket Set



- Removes and installs oxygen sensors on vehicles with computerized engine control
- Contents:
  - 3 - 1/2" Dr.
    - 29mm x 90mm (7mm slot), 27mm (12pt) x 82mm,
    - 22mm x 50mm (90°)
  - 4 - 3/8" Dr.
    - 7/8" x 90mm (20mm slot), 1-1/16" x 74mm,
    - 7/8" x 80mm (7mm slot), 22mm x 31mm (90°)

### T70045 Fuel Line Disconnect Tool



- Fits sizes: E=3/8", F=5/16"
- Releases locking couplings on 5/16" and 3/8" fuel lines

#### Applications:

GM 1989 to current, Ford 1990 to current, Mazda some models 1990 to current. Chrysler fuel injection models (except imports)

CAUTION - Release system pressure before using this tool

### T70046 A/C Fuel Line Spring Lock Coupling Tool



- For Ford sizes A=3/4", B=5/8", C=1/2", D=3/8"
- Easily releases locking couplings on fuel & air conditioning lines

#### Applications:

Ford 1981 to current, Chrysler LH series

CAUTION - Release system pressure before using this tool

### T70048 Ford / GM Quick Disconnect Tool



- Separates quick connectors from radiators, transmissions, power steering lines, and etc.

CAUTION - Release system pressure before using this tool

### T70096 9pc Spring Lock Coupling Tool Set



- Separates spring lock air conditioning, fuel and transmission line connectors
- Spring-loaded closed clamp deflects any spray when disconnecting pressurized lines
- A/C Spring Lock Disconnecter: Color coded set of 4 sizes: 3/8" (Red), 1/2" (Blue), 5/8" (Black), and 3/4" (White) Services 1981 to current Ford and some 1994 to current Chrysler vehicles
- Fuel Line Tool: Works on 5/16", 3/8", and 1/2" fuel lines 3/8" (Yellow), 1/2" (Green) fittings release spring lock connectors 5/16" (Gray), 3/8" (Blue) release quick connect fuel line fitting
- Transmission, Radiator and Fuel Line Quick Disconnect Tool: Removes push lock connectors found on this equipment

CAUTION - Release system pressure before using these tools



## T70098 6pc A/C & Fuel Line Quick Disconnect Tool Set



- Separates spring lock air conditioning, fuel line connectors
- Ideal for routine services on Ford, Chrysler, Jeep vehicles
- Convenient plastic holder included
- Sizes: 5/16", 3/8", 1/2", 5/8", 3/4" and 7/8"

CAUTION - Release system pressure before using this tool

## Fuel Filter / Line Tools



- Separates fittings on fuel lines, fuel filters, fuel tank return lines, and transmission cooler lines
- Color coded, anodized aluminum

### T70100 5/16" Fuel / Filter Line Tool

- 1990 - Current Ford Aerostar, Explorer, Bronco w/ 5/16" fuel lines
- 1991 - Current Ford E & F series trucks w/ 5/16" fuel lines
- 1992 - Current Ford Ranger w/ 5/16" fuel lines
- 1992 - Current GM w/ 5/16" fuel lines

### T70101 3/8" Fuel Line Tool

- 1990 - Current Ford Aerostar, Explorer, Bronco w/ 3/8" fuel lines
- 1991 - Current Ford E & F series trucks w/ 3/8" fuel lines
- 1992 - Current Ford Ranger w/ 3/8" fuel lines
- 1994 - 1997 Dodge Ram V6 & V8 trucks w/ 3/8" cooler lines
- 1995 - 1996 Dodge Ram Van / Wagon w/ 3/8" cooler lines

### T70102 1/4" Fuel Line Tool

- 1995 - 1996 Ford Mustang 1/4" fuel pump return line

### T70103 Oil Cooler Line Tool

- Ford Taurus & Escort oil cooler lines on AXOD & ATX transmission

CAUTION - Release system pressure before using these tools

## T75780 7pc Fuel / Filter Line Disconnect Tool Set



- Separates fittings on fuel lines, fuel filters, fuel tank return lines and transmission cooler lines
- Color coded anodized aluminum

T70100 - 5/16" Fuel Filter / Line Tool

T70101 - 3/8" Fuel Line Tool

T70102 - 1/4" Fuel Line Tool

T70103 - Oil Cooler Line Tool

T70047 - Ford Fuel Line Coupling Tool

T70048 - Ford / GM Quick Disconnect Tool

T70049 - Ford Oil Cooler Line Disconnect Tool

CAUTION - Release system pressure before using this tool

## T75781 6pc Fuel and Air Conditioning Line Disconnect Tool Set



- Separates fittings on fuel lines and air conditioning lines
- Color coded, anodized aluminum for easy identification
- 6 Most popular sizes fit most vehicles:  
5/16", 3/8", 1/2", 5/8", 3/4", and 7/8"

CAUTION - Release system pressure before using these tools





## T75779 11pc Disconnect Tool Set



- T70045 - Fuel Line Disconnect Tool
- T70046 - Ford A/C & Fuel Line Spring Lock Coupling Tool
- T70047 - Ford Fuel Line Coupling Tool
- T70048 - Ford / GM Quick Disconnect Tool
- T70049 - Ford Oil Cooler Line Disconnect Tool
- T70052 - GM Heater Line Disconnect Tool
- T70100 - 5/16" Fuel Filter / Line Tool
- T70101 - 3/8" Fuel Line Tool
- T70102 - 1/4" Fuel Line Tool
- T70103 - Oil Cooler Line Tool
- T71538 - Clutch Coupling Tool

This master quick disconnect tool set broadens the applications of disconnecting fittings and spring lock couplings on fuel, filter cooler and transmission oil lines.

### Applications:













- T70045 - GM 1989 - current, Ford 1990 - current, Mazda - some 1990 - current
- T70046 - Ford 1981 - current, Chrysler LH series
- T70047 - 1990 - current Ford Ranger & Explorer w/ 4.0L, 6 cyl engines
- T70048 - Ford CFI fuel lines with hair pin connectors; universal for radiator to transmission oil cooler lines; 1987 and later model Oldsmobile Tornado; Buick Riviera and Reatta; Cadillac Eldorado, Seville and Concours; 1989 and later model GM 1/2-ton, 3/4-ton, and 1-ton pickups
- T70049 - Ford vehicles with AXOD, AOD or ATX transmission
- T70052 - 1991- current GM 3.1L/3.4L and 3800 engines
- T70100 - 1990 - current Ford Aerostar, Explorer, Bronco w/ 5/16" fuel lines
  - 1991 current Ford E & F series Trucks w/ 5/16" fuel lines
  - 1992 current Ford Ranger w/ 5/16" fuel lines
  - 1992 current GM w/ 5/16" fuel lines
- T70101 - 1990 current Ford Aerostar, Explorer, Bronco w/ 3/8" fuel lines
  - 1991 current Ford E & F series Trucks w/ 3/8" fuel lines
  - 1992 current Ford Ranger w/ 3/8" fuel lines
  - 1994 - 1997 Dodge Ram V6 & V8 trucks w/ 3/8" cooler lines
  - 1995 - 1996 Dodge Ram Van / Wagon w/ 3/8" cooler lines
- T70102 - 1995 - 1996 Ford Mustang 1/4" fuel pump return line
- T70103 - Ford Taurus & Escort oil cooler lines on AXOD & ATX transmission
- T71538 - Ford Hydraulic Clutch

CAUTION - Release system pressure before using this tool



## T75791 Master Disconnect Tool Set



Illustration	Tool No.	Description	Vehicle
	<b>T70045</b>	Ford / GM / Chrysler fuel line disconnect tool	GM, Chrysler and some Ford vehicles with quick connect fuel lines
	<b>T70047</b>	Ford fuel line coupling tool	1990 and later model Ford Rangers and Explorers with 4.0 liter 6 cylinder engines
	<b>T70048</b>	Ford / GM quick disconnect coupler tool	Ford CFI fuel lines with hair pin connectors; universal for radiator to transmission oil cooler lines; 1987 and later model Oldsmobile Tornado; Buick Riviera & Reatta; Cadillac Eldorado, Seville and Concours; 1989 and later model GM 1/2-ton, 3/4-ton, and 1-ton pickups
	<b>T70049</b>	Ford oil cooler line disconnect tool	1986 and later model Ford vehicles with AXOD, AOD, or ATX automatic transmissions
	<b>T70052</b>	GM heater line quick disconnect separator	1991 and later model GM vehicles with 3.1, 3.4, and 3.8 liter V6 engines
	<b>T70095</b>	Ford A/C spring lock coupling tool, White (3/4")	1981 and later Ford models, some 1994 and later model Chrysler vehicles
		Ford A/C spring lock coupling tool, Red (3/8")	1981 and later Ford models, some 1994 and later model Chrysler vehicles
		Ford A/C spring lock coupling tool, Blue (1/2")	1981 and later Ford models, some 1994 and later model Chrysler vehicles
		Ford A/C spring lock coupling tool, Black (5/8")	1981 and later Ford models, some 1994 and later model Chrysler vehicles
	<b>T70174</b>	Fuel line disconnect tool Yellow (3/8"), Green (1/2")	1987 and later model Ford vehicles with spring lock connectors
	<b>T70175</b>	Fuel line disconnect tool Gray (5/16"), Blue (3/8")	GM, Chrysler and Ford vehicles with spring lock connectors
	<b>T70176</b>	Ford / Chrysler heater hose disconnect tool set	1986 and later model Aerostar vans, 1991 and later model full size (E-series) vans
	<b>T70177</b>	Ford heater hose disconnect tool, Black	1995 and later model Ford Crown Victoria and Mercury Grand Marquis with the 4.6 liter engine
	<b>T70178</b>	Chrysler fuel line disconnect tool	1994 and later model Chrysler LH vehicles, as well as other Chrysler vehicles with quick-connect fuel lines
	<b>T70179</b>	Ford / GM fuel line disconnect tool set	1992 and later model Chevrolet Lumina & Monte Carlo; Pontiac Grand Prix; Oldsmobile Cutlass Supreme; Buick Regal (all with ABS); 1998 & newer Ford pickups (at the fuel sending unit)
	<b>T71538</b>	Ford clutch coupling tool	1988 and later model Ford F series trucks, Bronco II's Rangers, Explorers 1989 and later model Ford Thunderbirds; Mercury Cougars

CAUTION - Release system pressure before using this tool



### T75700 Master Deluxe Line Disconnect Tool Set

- Separates fittings on fuel lines, fuel filters, and transmission cooler lines
- Unique offset design allows easy access in confined or obstructed areas
- Color coded , anodized aluminum for easy identification



<b>T70160</b> (Dark Grey)	Size: 1/2", Deluxe Line Disconnect Tool	for most 1/2" lines.
<b>T70161</b> (Blue)	Size: 5/8", Deluxe Line Disconnect Tool	for heater, A/C lines and more.
<b>T70162</b> (Black)	Size: 3/4", Deluxe Line Disconnect Tool,	for heater, A/C lines and more.
<b>T70163</b> (Silver)	Size: 7/8", Deluxe Line Disconnect Tool	for heater, A/C lines and more.
<b>T70164</b> (Red)	Size: 5/16", Deluxe Line Disconnect Tool	for fuel & cooler lines.
<b>T70165</b> (Gold)	Size: 3/8", Deluxe Line Disconnect Tool	for fuel & cooler lines.
<b>T70166</b> (Green)	Size: 3/8", Deluxe GM Cooler Line Disconnect Tool	for transmission cooler lines.
<b>T70167</b> (Purple)	Size: 3/8", Deluxe Cooler Line Disconnect Tool	for cooler lines on most Ford vehicles and on 2003 to current Cadillac CTS.

All disconnect tools are available individually packed

CAUTION - Release system pressure before using the tools

**T70024 Serpentine Belt Tool**

- Removes and installs belts on serpentine belt system
- Releases tension on serpentine belts with a spring loaded idler pulley
- Specially designed to reach confined areas
- Suitable for use on most types of vehicles
- Includes:
  - 4 - 3/8" Dr. 6pt Sockets (13, 15, 16, 18mm)
  - 3 - 3/8" Dr. Crowfoot Wrenches (13, 14, 15mm)
  - 2 - Bars (3/8" Dr., 1/2" Dr.)

**T75531 Serpentine Belt Tool**

- Removes and installs belts on serpentine belt systems
- Releases tension on serpentine belts a spring-loaded idler pulley
- Fits on most vehicles
- Contents:
  - 3 Bars for extra leverage
  - 13, 14, 15, 16, 18mm sockets and 3/8", 1/2" Dr. adapters (All sizes are designed with 16mm hex head and steel ball for easy locking to bars)
  - 3/8" - 16UNC nut

**T70022 Hydraulic Valve Tappet Remover**

- Slide hammer type tool removes stuck hydraulic valve tappets
- Includes puller adaptors for removing baked-in tappets

**T70026 Hydraulic Lifter Puller**

- Removes and installs hydraulic valve lifters
- Designed to fit into push rod holes
- Expands inside to remove lifter from bore
- For engines with space between the manifold and the head; no need to remove the manifold to replace the lifters

**T70031 Valve Spring Compressor**

- Removes valve spring in GM and other 8 cylinder engines using stud type rocker arms
- Compresses spring without removing cylinder head, by simply removing rocker arms and compress the spring by pulling handle

**T70033 2pc Valve Lapper Set**

- Sturdy hardwood handle and locking tap keeps valve from slipping and makes lapping easy
- Use with lapping compound (not included)



Model	Size
<b>T70029</b>	Small 5/8" and 13/16" Dia.
<b>T70030</b>	Large 1-1/8" and 1-3/8" Dia.





### T70034 Valve Spring Compressor

- Compresses springs without removing cylinder heads
- Adjustable cam action eliminates need to reset tool
- Lever can be removed and replaced with socket



### T70036 Valve Spring Compressor

- Great for compressing valve springs on overhead valve engines
- Use with cylinder head on or off the engine
- Adjustable jaws, GM adaptor included
- Works on Chrysler, Ford, Nissan and Toyota cars



### T70039 Overhead Valve Spring Compressor

- Suitable for a wide range of OHV, OHC & CVH engines
- Allows the replacement of valve springs & valve stem oil seals without removing the cylinder head



### T70032 Overhead Valve Spring Compressor

- Easily removes valve springs without removing cylinder head
- Offset jaws easily grip and compress valve springs
- Use with flexible air valve holders and air holder fittings to keep valves in place



### T70040 OHC Valve Spring Compressor

- Designed for vehicles with overhead cam engines
- Jaw opening: 68mm-130mm



### T70041 Valve Spring Compressor

- Compresses valve springs on L-head and overhead valve engines
- Jaw opening: 90mm-250mm
- Throat depth: 9-3/4"



### T70042 Valve Spring Compressor

- Compresses valve springs on overhead valve engines
- Jaw opening: 75mm-165mm
- Throat depth: 7-1/2"



### T70043 Valve Spring Compressor

- Compresses valve springs on "L" head and small overhead valve engines
- Strong, rigid frame keeps valve springs positively compressed during work
- Jaw opening: 75 - 135mm, Throat depth: 160mm





### T70044 Valve Spring Compressor

- Compresses valve springs of OHC, OHV and CVH car and truck engines with recessed valves
- Jaw opening: 2-3/16" to 6-7/8"
- Throat depth: 6-1/2"
- Features dual cam-action, parallel lift, automatic locking, flexible valve keeper and magnetic jaws



### T75538 Heavy Duty Valve Spring Compressor

- Heavy duty construction
- Compress valve springs for motorcycles and most vehicles
- 3 pushers to fit valve spring correctly and compress valve spring easily
- Sizes: 16.5 - 19mm, 21.5 - 23mm, 23.5 - 25mm  
2 threads: 50mm and 90mm



### T75502 Universal Valve Spring Compressor



The ideal solution for removing and installing valve springs. This tool can also be used without removing the cylinder head from the engine. Adjustable base positioning with fastening bolts immobilizes the tool while you work. Springs are efficiently compressed by single handed strokes of the adjustable lever, allowing access to remove or install spring retaining keepers. Operates on most domestic and import single / double overhead cam engines.

#### Applications:

Audi, Chrysler, Infiniti, Honda, Hyundai, Lexus, Mazda, Mitsubishi, Nissan, Porsche, Saturn, Toyota, Volvo, and Volkswagen

### T72140 12pc Drain Plug Key Set



Key:

A = Black Axle, B = Gear Box, C = Sump

Hex	Square
8mm - BMW (A), Ford (B), GM (A,B)	8mm - Peugeot (A,B,C), Citron (B,C), Renault (C), Talbot (B,C), Volvo (C)
9mm - GM (A),	
10mm - Ford (A),	11mm - Ford (A,B),
12mm - Lancia (B,C), Peugeot Talbot (B,C)	13mm - Nissan (A,B), Subaru (A)
14mm - Lancia (B,C), Mercedes (A,B)	3/8" - Honda (B,C), Mazda (A,B), Renault (B,C), SAAB (B), Volvo (A,C)
17mm - Audi (B), Austin (B), BMW (B), VW (B)	
3/8" - BLMC (A)	

### T75830 8pc Professional Grease Accessories Kit



#### Includes:

- 3 - 18" Grease Hose, 12" and 18" Grease Hoses with Spring
- 1 - Needle Nozzle
- 1 - Locking Swivel Coupler 9 1/8" NPT (F)
- 1 - Needle-Nose Grease Dispenser
- 1 - Angle Lube Adaptor
- 1 - Extension Coupler

- Convenient accessories kit for hand-operated grease guns
- Easily lubricates recessed fittings, steering and suspension systems on late model front wheel drives
- Locking sleeve adapters allow quick attachment to coupler of any control valve or lever gun



### T70061 Professional Mechanics Stethoscope

- Sensitive, shockproof instrument easily locates noises in engines, bearings, and other moving parts
- Includes aluminum alloy probe / needle, surgical PVC, rubber trumpet, and plastic earphones



### T70063 Automotive Stethoscope

- Quickly and accurately locates noise and trouble in engine and moving parts
- Includes a supersensitive plastic bulb diaphragm and two sensor probes



### T70065 Rocker Arm Oil Plug Set

- Designed for late-model vehicles with hollow, oil-fed push rods
- 16 steel spring, clip-on oil plugs stored in convenient plastic case



### T70068 Pulley Puller

- Removes pressed on 1 or 2 groove pulleys from alternators or power steering pumps
- Also easily removes alternator bearings
- Adjusted by simple thumbscrew movement



### T70069 Pulley Removing Wrench

- Perfect for removing or assembling grooved pulleys on V-type belts
- Ideal for alternators and water pump pulleys, electric motors, tool machines, washing machines, and etc.



### T71120 Power Steering Pump Pulley

- Dual function impact tool
- Double-sided flange fits most domestic vehicles
- Removes grooved power steering pumps
- Fits alternator pulleys from 1-1/8" to 1-3/8" (28-35mm)



### T70074 Power Steering Pump Pulley Kit



- Removes and installs power steering pump pulleys
- Includes: Pulley remover, pulley installer and quick disconnect coupler tool
- Compatible with most current domestic cars

#### Applications:

1998 to current GM Quad 4 engines; 1990 to current Chevrolet Lumina APV, Pontiac TransSport, Olds Silhouette; 1991 to current (3.1L V-6) Chevrolet Lumina sedan, Pontiac Grand Prix; 1991 to current Ford (4.6L engines)



### T75521 Power Steering Pump Pulley Replacer

- Time saving tool installs power steering pump pulleys and GM press-on type water pump pulleys
- Features a thrust bearing for easy turning and prevents pump damage
- Works on most Chrysler, Ford, GM, and VW cars



### T70115 Universal Camshaft Pulley Holding Tool

- Specially designed with grooved pins to hold camshaft pulley firmly while loosening and tightening center shaft bolt
- Works on Nissan Maxima (VG30 engine), Toyota Camry (3VZFE & 1MZFE engines) and other popular Asian overhead cam engines



### T70083 Fan Hub Wrench - 32mm

### T70084 Fan Hub Wrench - 36mm

- Specifically designed to remove thermo-viscous fans fitted to Ford Granada, GM Carlton and Senator engines



### T70137 Water Pump Pulley Holding Wrench

- Easily loosen stubborn bolts on water pump pulley
- Safely locks water pump pulley
- Works on VW and Audi



### T70145 Water Pump Pulley Holding Wrench

- Easily loosen stubborn bolts on water pump pulley
- Safely locks water pump pulley
- Use with 1/2" Dr. ratchet
- Works on VW and Audi



### T70139 Camshaft Alignment Tool - Audi V6

- Designed for easy fixing on crankshaft works
- Lock camshaft safely
- Works on Audi 80, 100, A4, A6, A8, Coupe / Cabrio 2.6 & 2.8, ABC / AAH (1991-1995)



### T70142 Camshaft Alignment Tool -VW, Audi V6

- Designed for easy fixing on crankshaft works
- Lock camshaft safely
- Works on 1995-2004 new style VW, Audi V6



### T70143 Camshaft Alignment Tool -VW, Audi V8

- Designed for easy fixing on crankshaft works
- Lock camshaft safely
- Works on VW, Audi V8 5-valve







### T70140 Camshaft Alignment Tool - VW, Audi

- Designed for easy fixing on crankshaft works
- Lock camshaft safely
- Works on VE, Audi, 1.4 / 1.6L, VW Lupo, Polo, Golf IV, Bora / Audi A2



### T70141 Camshaft Alignment Tool - VW, Audi

- Designed for easy fixing on crankshaft works
- Lock camshaft safely
- Contents: injection pump locking pin, tensioner locking tool, crankshaft locking tool
- Works on Audi, VW, Seat, Skoda with TDI PD and V6 engine



### T70579 Timing Tool Set

- Specially designed to correct timing adjustment on VAG 2.0L, TPI PD DOHC engines
- Essential tools for setting and locking the engine
- Works on Audi A4, A6, VW Golf, Jetta, Touran, Skoda



### T70155 Crankshaft Locking Pin - 12mm

### T70156 Crankshaft Locking Pin - 18mm

- Specially designed to fix crankshaft angle
- To correct timing adjustment
- Works on VW, Audi V6, V8 engines



### T70157 Crankshaft Locking Tool

- Specially designed to lock crankshaft
- Works on VW, Audi, Seat, Skoda 2.0 TDI engine



### T75637 Camshaft Alignment - BMW

- Designed for easy fixing on crankshaft works and set camshaft timing
- Lock camshaft safely
- Works on BMW M40, M70 engine



### T75638 19pc Timing Locking Tool Set



- Master timing lock tool set to correct engine timing while replace the timing belt
- Works on Ford, Mazda, Opel, Saab, Land Rover, Citroen, Peugeot, VW, Isuzu, Honda and most import vehicles



### T75639 Timing Tool Set



- Specially designed to correct timing adjustment
- Works on VW Lupo, Polo 1.2 L engines

### T70170 Valve Adjusting Tool -Nissan

- Specially designed for easy valve adjustment on all Nissan and most vehicles with overhead camshaft engines using spacer shims



### T70171 Valve Adjusting Tool -Toyota

- Specially designed for easy valve adjustment on all Toyota Lexus and most vehicles with overhead camshaft engines using spacer shims



### T70172 Valve Adjusting Tool

- Specially designed for easy valve adjustment on overhead camshaft engines
- Works on Volvo, Opel and many other european vehicles



### T70545 Valve Stem Seal Remover

- Efficiently removes valve stem seals as well as lower valve spring guides
- Long, heavy duty handles for extra leverage
- Serrated jaws ensure a non-slip grip of the seal
- Narrow design for access in confined spaces



### T70173 Diesel Injection Pump Wrench

- Specially designed to fasten injection pump screws when replacing toothed belt and adjusting injection start
- Size - 13mm, 12pt
- Works on Audi 80, 1.6 4 cyl diesel engine, VW Golf, Jetta, Caddy, Passat and Santana



### External Thread Restorer Files

- Restores damaged threads on any diameter bolt, stud, axle or shaft
- Renews both right and left hand threads



Model	Thread size
<b>T73430</b>	0.75, 1.0, 1.25, 1.50, 1.75, 2.0, 2.5, 3.0
<b>T73431</b>	11, 12, 13, 14, 16, 18, 20, 24
<b>T73432</b>	9, 10, 12, 16, 20, 27, 28, 32



### T73433 External & Internal Restorer Files (Metric)

- Restores damaged threads on any diameter bolt, stud, axle, or shaft. Renews both right and left hand threads
- Designed for narrow areas
- Thread sizes (Metric):  
0.75mm, 1.0mm, 1.25mm, 1.5mm, 1.75mm, 2mm, 2.5mm, and 3mm



### T73434 External & Internal Restorer Files (SAE)

- Restores damaged threads on any diameter bolt, stud, axle, or shaft
- Renews both right and left hand threads
- Designed for narrow areas
- Description pitch sizes SAE file:  
24 - 20 - 18 - 16 - 14 - 12 - 11 - 10



### T75607 Axle Spindle Re-Threading Set



- Includes:  
Die Sizes: M24 x 1.50, M24 x 2.00, M22 x 1.00, M22 x 1.50, M20 x 1.50, M20 x 1.25, 13/16" x 20UNF, 3/4" x 20UNF

This tool set accesses axle threads on spindles of eight popular die sizes for both cleaning and rethreading jobs.

Operates with 1-1/4" socket or wrench

Applications:

Most domestic or imported front wheel drive vehicles

### T75611 Universal Outside Threader Chaser



- Includes:  
6 Thread chaser dies, SAE threads per inch:  
4, 5, 6, 7, 7-1/2, 8, 9, 10, 11, 11-1/2, 12, 14, 16, 18, 20, 24  
Metric threads per pitch:  
1.0mm, 1.25mm, 1.5mm, 1.75mm, 2.0mm, 2.5mm, 3.0mm, 3.5mm

The damage-free solution for repairing external threads, and restoring them to their original condition.

Capacity range: 1-1/4" to 5" O.D.

### T75617 5pc External Thread Restorer File Set



- Includes:  
Metric File: 0.75mm, 1.0mm, 1.25mm, 1.5mm, 1.75mm, 2mm, 2.5mm, 3mm  
SAE File: 11, 12, 13, 14, 16, 18, 20, 24 threads per inch  
SAE File: 9, 10, 12, 16, 20, 27, 28, 32 threads per inch  
SAE Thread Pitch Gauge Sizes: 4, 4.5, 5, 6, 7, 8, 9, 10, 11, 12, 14, 16, 18, 19, 20, 22, 24, 26, 28, 32, 40, & 48 threads per inch  
Metric Thread Pitch Gauge Sizes: 0.40, 0.45, 0.50, 0.55, 0.60, 0.70, 0.75, 1.00, 1.25, 1.50, 1.75, 2.0, 2.5, 3.0, 3.5, 4.0, 4.5, 5.0, 5.5, and 6.0mm
- Effectively repairs and restores external threads to their original condition on any diameter stud, bolt, shaft or axle, renews LHS or RHS threads efficiently by filing and cutting
- Screw pitch gauges measure U.S. or "V" threads in SAE and Metric sizes



### T75621 43pc Re-Threading Set -UNC, UNF, Metric Sizes



- A comprehensive re-threading kit for repairing or renewing damaged threads on nuts, bolts or studs
- Highly tempered, hex-shaped for socket or wrench use

#### 21 Re-Threading Dies: (For chasing (repair) work only)

National Coarse (Silver): 1/4", 5/16", 3/8", 7/16", 1/2", 9/16", 5/8"

National Fine (Black): 1/4", 5/16", 3/8", 7/16", 1/2", 9/16", 5/8"

Metric (Gold): 6 x 1.00, 8 x 1.25, 10 x 1.25, 10 x 1.50,  
12 x 1.25, 12 x 1.50, 12 x 1.75mm

#### 19 Re-Threading Taps:

National Coarse: 1/4", 5/16", 3/8", 7/16", 1/2", 9/16"

National Fine: 1/4", 5/16", 3/8", 7/16", 1/2", 9/16"

Metric: 6 x 1.00, 8 x 1.25, 10 x 1.25, 10 x 1.50, 12 x 1.25,  
12 x 1.50, 12 x 1.75mm

#### 3 Thread Files (4-sided):

SAE: 11, 12, 13, 14, 16, 18, 20, & 24

SAE: 9, 10, 12, 16, 20, 27, 28, & 32

Metric: 0.75, 1.00, 1.25, 1.75, 2.00, 2.50, & 3.00mm

### T75623 18pc Re-Threading Set - UNC, UNF



- Repairs or renews damaged threads on nuts, bolts or studs Highly tempered, hex-shaped for socket or wrench use

#### 16 Re-Threading Dies: (for chasing i.e. repair work only)

National Coarse (Silver): 1/4", 5/16", 3/8", 7/16", 1/2", 9/16", 5/8", 3/4"

National Fine (Black): 1/4", 5/16", 3/8", 7/16", 1/2", 9/16", 5/8", 3/4"

#### 2 Thread Files for repairing external threads:

8 sizes (threads per inch): 10, 12, 14, 16, 18, 24, 27 & 32

### T75624 15 pc Re-Threading Set - Metric sizes



- Repairs or renews damaged threads on nuts, bolts or studs Highly tempered, hex-shaped for socket or wrench use

#### 7 Re-Threading Dies: (for chasing i.e. repair work only)

6 x 1.00, 8 x 1.25, 10 x 1.25, 10 x 1.50, 12 x 1.25, 12 x 1.5, 12 x 1.75mm

#### 7 Re-Threading Taps:

6 x 1.00, 8 x 1.25, 10 x 1.25, 10 x 1.50, 12 x 1.25, 12 x 1.5, 12 x 1.75mm

#### 1 Thread File for repairing external threads:

0.75, 1.25, 1.75, 2.50mm

### T75785 Universal Camshaft Bearing Tool



- Includes:  
Driving shaft and extension, Expander unit, 5 Split driving plugs,  
2 Driving washers, Centering cone

Removes and installs camshaft bearings. Works with bearings ranging from 1.125" to 2.69". Winding hex nut expands the driver, utilizing mechanical screw power in order to remove or install bearings. Force is equally distributed during expansion, leaving both bearing and bearing housing undamaged. Also includes a centering cone for bearing guidance and protection.





### T75803 Engine Lift Chain

- Allows safe, easy lifting of car and truck engines into and out of engine compartments
- Holds up 1000 lbs with a spread no more than 20 inches
- Operates with most domestic and import vehicles



### T70108 Universal Tensioning Gauge for Cambelts

- Easily adjust cambelt tension where the movement of timing belt is measured by load
- Dual scale for easy reading from top or bottom of the tool
- Incremental marking with knurled knob for precise measurement
- Works on cambelts with various belt thickness



### T70169 Universal Twin / 4 Cam Locks - Gas & Diesel Engines

- Designed to lock twin camshafts for timing marks when replacing timing belt
- Extendable arm to lock into sprocket teeth, also lock between cam and diesel injection pump sprockets
- Easy one man operation



### T75836 Rear Axle Bush Removal Tool

- Removes and replaces rear upper and lower bushes on trailing arm axles
- Works on Opel Vauxhall, Vectra



### T75837 Rear Axle Bush Installation Tool

- Removes and installs rear axle mounting bushes
- Use with ratchet to insert composite bushes
- Works on Audi A3, VW Bora, Golf IV



### T75838 Rear Axle Bush Removal Tool

- Removes and installs rear axle mounting bushes without removing suspension trailing link
- Works on Ford Fiesta from 1996



### T70082 Universal Clutch Alignment Tool Set

- Designed for most vehicles up to 5 tons with single plate clutches and front wheel drives without pilot bearings in the flywheel
- Assembly is performed on the workbench, allowing for easy installation



### T70080 7pc Clutch Alignment Tool (Metric)

- Aligns clutch plates and pilot bearings for easy clutch repair or replacement
- Fits most metric clutch plates
- Includes five 2-step pilot bushings, 2 plate alignment cones, and one alignment shaft
- Sizes: 11.85. 13.85. 15.8. 16.7. 18.98mm





### T70062 Ford Fan Clutch Wrench

- Removes and replaces viscous fan clutch assemblies on Ford Falcons, Fairlanes, etc.
- Fits both 6 & 8 cylinder engines
- Features elongated slots for extra firm grip



### T75508 Ford Fan Clutch Wrench Set

- Special size two-piece set for servicing fan clutch on Ford 4.9 L engines
- Includes: flat wrench and crow foot
- Use with 1/2" Dr. breaker bar for extra torque



### T75512 4pc Fan Clutch Wrench Set



- Includes:
  - 1-9/16" and 1-7/16" Double-Ended Wrench
  - 2-1/4" Holding Wrench with 1/2" Square Drive
  - 1-7/8" Single-Ended Wrench
  - 3-1/4" Holding Wrench with 1/2" Square Drive

The perfect tool for removing and installing fan clutch assembly on most Ford engines. The holding wrench is used to immobilize the fan clutch while the nut wrench twists the nut on or off. Greater torque may be added by attaching a ratchet, breaker bar, or torque wrench to the square drive on the holding wrenches. The small double-ended wrench is for 2.8, 2.9, 3.0, 4.0, & 4.9 liter engines. The large single-ended wrench and the large holding wrench are for 6.9 and 7.3 liter diesel engines.

### T70079 17pc Clutch Alignment Tool



- Set includes 16 two-step pilots for sizes larger than 32 applications
- For most foreign and domestic cars and trucks
- Includes: plastic case

### T75526 Fan Clutch Service Tools Set - Benz, BMW



- Specially designed to remove and install thermo-viscous fan clutch fitted to Mercedes-Benz and BMW
- The holding wrench is used to immobilize the fan clutch while nut wrench twists the nuts on or off
- Allows to work on confined area
- Contents: 3 fan clutch tools - 32, 36, 65mm, 3 fan clutch holders and fan belt service wrench



## Piston Ring Compressor



- Steel spring band, easy release switch for adjustable friction brake
- Heavy duty construction
- Positive locking ratchet

Model		Height
<b>T70085</b>	40-80mm	2"
<b>T70086</b>	53-125mm	3"
<b>T70087</b>	53-175mm	3"
<b>T70088</b>	54-127mm	3-1/2"
<b>T70089</b>	89-178mm	3-1/2"
<b>T70090</b>	60-175mm	4"
<b>T70091</b>	60-175mm	6"
<b>T70092</b>	90-175mm	6"

## T75524 Wrinkle Band Ring Compressor

- One adjustment fits 3-5" piston rings
- Wrinkle band design greatly reduces ring friction
- Features thumbscrew precision adjustment
- Operates on most domestic and import vehicles



## T70185 Piston Ring Expanding Device

- Universal design can be used on most vehicles
- Smooth gripping edge prevents damage to piston ring during installation
- Capacity: 50 - 100mm



**T70186** 80 - 100mm

**T70187** 110 - 160mm

## T75523 Ring Groove Cleaner



- Equipped with heavy coil spring to keep cutter in place while it removes carbon from piston grooves on 2-3/4" to 5" pistons
- Cutters rotate to the correct size and lock in place
- Includes:

3 cutter wheels with sizes:

1.2, 1.5, 1.8, 2.0, 2.5, 2.8, 3, 4, 4.5, 5, 5.5mm

1/6", 5/64", 3/32", 1/8", 5/32", 3/16", 1/4"

## T75860 Ridge Reamer - Lathe Type



Removes ridges from engine cylinder walls. Takes imperfections and ridges out of cylinder wall with a lathe-type action with one setting. There is no need to re-adjust the tool when changing from one cylinder to another. Removable tungsten carbide cutter and fine threaded feed screw ensure clean cut action.

Operating range: 3" - 5" diameter cylinders

**T70147 Adjustable Piston Ring Installer**

- Removes and installs piston rings on most cars and light trucks and reduces piston ring breakage
- Tapered steel jaws
- Non-slip, vinyl grip

**T70556 Exhaust Manifold Spreader**

- Installs manifolds on small block Chevrolets
- Prevents cross threading on manifold bolts by keeping bolt holes accurately aligned
- Most effective when used in pairs

**T70149 Engine Cylinder Hone with 3" Stones**
**T70200 Engine Cylinder Hone with 4" Stones**

- Removes glaze and scratches from engine cylinders
- Adjustable honing tension ensures steady, smooth contact with cylinder wall
- Capacity: 2" - 7"
- Operates with any electric drill

**T70150 3pc Replacement 3" Medium Grit Stones**
**T70201 3pc Replacement 4" Medium Grit Stones**
**T75603 Piston Ring Compressor Set**

- Includes:  
Ratcheting Pliers and 6 Interchangeable Bands
- Sizes:  
2-7/8" - 3-1/8", 3-1/8" - 3-3/8", 3-3/8" - 3-5/8", 3-5/8" - 3-7/8"  
3-7/8" - 4-1/8", 4-1/8" - 4-3/8"

Installs piston rings ranging from 2-7/8" to 4-3/8" into cylinder block. Fine-tooth ratcheting plier permits band compression in small increments. Operates both vertically and horizontally.

**T70075 Self-Adjusting Clutch Rotating Tool**

- Rotates the self-adjuster mechanism on Spicer self-adjusting clutches
- Compatible with either open end or box wrenches for clutch adjustment

**T70076 Truck Clutch Adjusting Wrench**

- Specially designed tool for adjustment on heavy duty Spicer angle spring and multi-lever clutches
- Essential for adjusting clutches on heavy duty truck without damaging parts







### T70501 Compression Tester

- Color-coded, quadruple calibrations with 0-300 psi, 21kg/cm<sup>2</sup>, 21bar, and 2100kpa
- Rubber cone adaptor fits all spark plug holes
- Calibrates both SAE and Metric fittings



### T70503 Flex Drive Compression Tester

- Accurately checks compression on gasoline engines
- Color-coded, quadruple calibrations with 0-300psi, 21kg/cm<sup>2</sup>, 21bar, and 2100kpa
- Heavy duty, flexible hose with a 14/18mm adaptor



### T70505 Compression Tester Kit

- Color-coded, quadruple calibrations with 0-300 psi, 21kg/cm<sup>2</sup>, 21 bar, and 2100 kpa
- 6" heavy duty stem and 13" flexible hose included



### T70507 Vacuum & Fuel Pump Tester

- Locates fuel leaks, vacuum chokes, heating leaks, and valve trouble
- Full 2-1/2" dial, color-coded scales
- Includes heavy duty, flexible hose and universal nose-cone adaptors



### T70537 Professional Anti-Freeze Tester

- Six color-coded disks give accurate percentage anti-freeze readings
- Break resistant, magnifying tube shows reading clearly



### T70538 Deluxe Anti-Freeze Tester

- Shows two scales: freezing point of radiator solution and boiling point of summer coolant
- Precision calibrated rubber bulb
- Extra long rubber tip
- Tests all ethylene glycol solutions



### T70539 Professional Anti-Freeze Tester

- Accurately tests ethylene glycol based anti-freeze under all temperature conditions
- Extra length tip allows extended reach



### T70540 Propylene Anti-Freeze Tester

- Accurately tests propylene glycol based anti-freeze under all temperature conditions
- Extra length tip allows for extended reach





## T75541 Petrol Engine Compression Tester Set



- Comprehensive test kit for import and domestic petrol engine powered cars and motorcycles
- 250mm flexible hose allows access to restricted plug ports
- Dual-scale compression gauge: 0-290 psi (0-20 bar)
- Convenient quick coupler adaptors for efficiency
- Designed for repeat testing without disassembly
- Thread chasers included to ensure accurate readings
- Extensions access deep seated plug ports easily

Contents:

	Length (mm)	Gauge	Scale
Gauge assy.	330	80mm dia.	0-20 Bar (290psi)

Gauge includes general purpose M14 & M18 plug ports

### Plug Port Extensions:

M10, M12, M14 (64mm), M14 (94mm), M18

### Thread Chasers

M10, M12, M14, M18

Service Kit:

8 Replacement O-Rings & release valve

## T75542 Diesel Engine Compression Tester Set (LARS)



- Comprehensive test kit for direct and indirect diesel injected vehicles
- 355mm flexible hose allows access to restricted plug and injector ports
- Dual-scale compression gauge (0-1000 lb/sq in and 0-70 bar)

Contents:

	Length (mm)	Gauge
Gauge Assembly Scale: 0-70 Bar (1000psi)	560	83mm dia
	Length (mm)	Thread
Glowplug adaptor	73.5	M10 x 1.25
Glowplug adaptor	54.0	M12 x 1.25
Glowplug adaptor	72.0	M14 x 1.25
Dummy injector	114.0	N/A (21mm OD)
Dummy injector	64.0	M24 x 2.00
Stanadyne dummy injector	112.0	N/A (19mm OD)
Glowplug adaptor	114.5	M10 x 1.25
Glowplug adaptor	119.0	M10 x 1.00
Dummy injector	78.0	M20 x 1.50
Clamp plate (17mm diameter hole)	63.5	25mm (width)

Replacement seal & washer set, 90 degree elbow



## T75543 Diesel Engine Compression Tester Set (CVS)



- Comprehensive test kit for direct and indirect diesel injected commercial, marine, and industrial engines
- 355mm flexible hose allows access to restricted plug and injector ports

Contents:

Item	Length (mm)	Gauge	Scale
Gauge Assembly	560	100mm dia.	0-70 Bar (1000psi)
Item	Int Thread	Thread	Ext. Thread
Centre Pillar	185	5/16" x 24 UNF	1/2" x 20 UNF
Spacer Set	Ext. Diameter	Length	
End Adaptor	20.5	30	
End Adaptor	23.6	32	
End Adaptor	23.6	41	
Clamp plate	Length	Width	Hole Dia.
Clamp plate	63.5	25mm	17mm
Clamp plate	76.2	15mm	17mm
Replacement seal & washer set, 90 degree elbow			

## T75545 Oil Pressure Tester Set



- Accurately tests & diagnoses the oil system pressure for all engines
- Easily checks the pressure delivery of oil pumps, tests pressure switches and warning indicators
- 1300mm flexible hose is permanently oil primed, length allows easy access
- Dual scale compression gauge: 0-140 psi (0-10 bar)
- Convenient labor saving "quick-coupler" adaptors
- Quick shut-off valve for efficiency & protection

Contents:

	Length (mm)	Gauge	Scale
Gauge Assy.	1300	80mm Dia.	0-10 Bar (140psi)
Adaptors			
R1/8 DIN 2999			
1/8" x 27 NPT, 1/4" x 18 NPT, 3/8" x 20 UNF, 1/2" x 20 UNF, M10 x 1.0 M12 x 1.5, M14 x 1.5, M16 x 1.5, M18 x 1.5, 90 Degree elbow			



### T70547 Hose Pinch-Off Pliers

- Ideal for clamping fuel lines, brake lines & vacuum hoses
- Quick adjusting slide clamp ring
- Corrosion & chemical resistant tough PVC
- Size: 3/4" to 2-1/4"



### T70564 2pc Hose Pinch-Off Pliers

- Special radius jaws to avoid damaging hoses
- Lightweight and non-conductive
- For use on all brake and fuel lines
- Capacity: 1/2" - 3/4" and 1/4" - 7/16"



### T70565 Hose Pinchers

- Quickly and easily pinches-off vacuum and fuel lines
- Pinches without causing any damage to hose or tube
- Not for use on wire reinforced radiator hoses



### T70578 Hose Remover Pliers

- Simplifies the removal of fuel & vacuum hoses from tube fittings, without damaging the tube or hose
- Spring loaded, fits sizes 5/32" to 1/2" (4mm-13mm)



### T70577 Professional Hose Remover Pliers

- Easy remove 4mm -21mm vacuum and fuel hoses
- Mini non-slip jaw design for better gripping



### T70584 3pc Hose Pinch-Off Pliers Set

- Pinches-off vacuum and fuel lines
- Changes thermostats without draining cooling system
- Automatic locking ratchet
- Contents: 8", 10", 12"



### T70630 Flexible Hose Clamp



- Specially designed for easy hose replacement
- Locking pliers mechanism allows technician to hold clamp into open position
- Easily removes self-tightening hose clamps with diameters of 11/16" - 2-1/2"
- 24" heavy duty flexible cable to access hard-to-reach areas





### T72072 Front Wheel Drive Axle Puller Adaptor

- Use with slide hammer with 5/8"-18 thread (T75906) to extract the axle assembly or CV Joint from the shaft when servicing front wheel drive vehicles
- Fits Ford Tempo, Topaz, Exp, and Lynx



### T73915 Flange Type Axle & Wheel Hub Puller

- For use on most cars and light trucks
- For use on 4 or 5 bolt designs and all non-C clock GM axles



### T73916 Front Hub Remover / Installer Set



- Universal design for pulling off front hubs and aligning interference fit spline halfshafts during installation
- Removes and installs front hubs during CV joint replacement, transaxle and wheel bearing servicing without damaging wheel bearings
- Ensures proper installation of spline halfshafts into the front hub of Escort, Lynx, Tempo, Taurus & Sable vehicles
- The puller fits most FWD vehicles
- Additional locknut enables the use of a standard slide hammer puller for removal of rear axle flanges

### T75937 GM Timing Belt Wrench

Fits into the confined space between the radiator housing and the water pump assembly. Suitable for 1982 – 1989 GM four cylinder 1.8 to 2.0 liter engines. It rotates the water pump and simultaneously adjusts the fan belt tension. Corrosion resistant black oxide coating.



### T75904 Timing Gear Puller

- Removes timing gears, fan pulleys, balancers and other automotive components with tapped holes
- Drop forged, plated steel yoke resists corrosion
- Heat-treated center bolt



### T75800 Camshaft Drive Belt Pulley Puller



- Specially designed to pull camshaft belt pulley wheels
- Works on VW 4, 6 cylinder, V6, V8 engines and Audi petrol engine



### T73876 13pc Harmonic Balancer Puller



- Designed to pull vibration dampers, balancers, pulleys and gears with tapped holes
- 10pc Cap screws - 3/8"-24 x 2" (3), 5/16"-18 x 2" (3), M8 x 1.25 x 80m (2), 3/8"-16 x 4" (2)
- 1pc - 5/8" Main center bolt
- 1pc - 4 Slot yoke
- 1pc - Pointed shaft protector

### T75916 14pc Harmonic Balancer Puller Set



- Includes:
- 11pc Cap screws - 3/8" - 24 x 2" (3), 5/16" - 18 x 2" (3) M8 x 1.25 x 80m (3), 3/8" - 16 x 4" (2)
- 1pc - 5/8" Main center bolt
- 1pc - 4 Slot yoke
- 1pc - Pointed shaft protector

This device removes vibration dampers, balancers, pulleys and gears with tapped holes. Force is evenly distributed upon application. Puller can be used to pull out most objects since it works on either two or three tapped holes. Use with a wrench for more winding power. Applies to most foreign and import vehicles.

### Heavy Duty Reversible Gear Puller



- Reversible steel jaws
- Chrome Vanadium steel, heavy duty construction
- Drop forged yokes, heat-treated jaws and center bolt

2 Jaw	3 Jaw	Capacity
T74102	T74132	3" Gear Puller
T74163	T74193	4" Gear Puller
T74104	T74134	6" Gear Puller
T74105	T74135	8" Gear Puller
T74106	T74136	10" Gear Puller
T74107	T74137	12" Gear Puller

### Heavy Duty Gear Puller



- Heavy duty construction
- Drop forged yokes, heat-treated jaws and center bolt

2 Jaw	3 Jaw	Capacity
T74162	T74192	3" Gear Puller
T74169	T74199	4" Gear Puller
T74164	T74194	6" Gear Puller
T74165	T74195	8" Gear Puller
T74166	T74196	10" Gear Puller
T74167	T74197	12" Gear Puller



## Two Arm Puller w/ Adjustable Arms



- Heavy duty construction
- Drop forged yokes, heat treated jaws and center bolt
- Adjustable steel jaws

Model	Capacity
<b>T74113</b>	Two Arm Puller w/ Adjustable Arms 30 - 80mm
<b>T74114</b>	Two Arm Puller w/ Adjustable Arms 30 - 120mm
<b>T74115</b>	Two Arm Puller w/ Adjustable Arms 40 - 160mm
<b>T74117</b>	Two Arm Puller w/ Adjustable Arms 40 - 200mm

## Heavy Duty Reversible 2/3 Jaw Combination Gear Puller



- Reversible steel jaws
- Chrome Vanadium steel, heavy duty construction
- Drop forged yokes, heat-treated jaws and center bolt
- Convertible between 2 or 3 jaws

Model	Capacity
<b>T75917</b>	3" 2/3 Jaw Combination Gear Puller
<b>T75918</b>	4" 2/3 Jaw Combination Gear Puller
<b>T75919</b>	6" 2/3 Jaw Combination Gear Puller

## Bearing Puller



- Ideal for pulling bearings from electrical tools and autoelectrical equipment e.g. generator, alternator, starter bearings and bushings
- Powerful enough to remove wheel & flywheel pilot bearings from most passenger domestic and import vehicles

Model	Size
<b>T73920</b>	Bearing Puller (24 - 55mm)
<b>T73921</b>	Bearing Puller (35 - 80mm)
<b>T73922</b>	Bearing Puller (19 - 35mm)

## T75532 Transmission / Transaxle Plug Set



- Includes Five Stepped Plugs:  
1" - 1.25", 1.3" - 1.55", 1.6" - 1.85", 1.95" - 2.18"  
For Ford Transaxle

Five stepped plugs are custom designed to operate on both transaxle and transmissions to prevent any loss of transmission fluid when repairing the drive shaft U-joint.

### Applications:

Most rear wheel drive vehicles:  
import and domestic cars and pickup trucks



## T75501 Power Steering Pump Pulley Set



Includes:

- Pulley Remover
- Pulley Installer
- Quick-Disconnect Coupler Tool

Removes and installs steering pump pulleys in no time. Works with Chrysler, GM, Thompson and Ford. Both the pulley remover and pulley installer work readily without damaging the pump or the pulley. Each comes with two screw shafts for various pump sizes. Fits pulley hub diameters of 1-1/8", 1-1/4", 1-5/16", 1-3/8".

Applications:

- 1988 to current GM Quad 4 engines
- 1990 to current Chevrolet Lumina APV, Pontiac TransSport, Oldsmobile Silhouette
- 1991 to current (3.1L V-6 engines) Chevrolet Lumina sedan, Oldsmobile Cutlass Supreme, Buick Regal, Pontiac Grand Prix
- 1991 to current Ford (4.6L engines)

The included disconnect coupler tool disconnects the fuel line on most 1987 to current Cadillac, Oldsmobile and Buick vehicles  
1989 to current GM 1/2 Ton, 3/4 Ton and 1 Ton pickups  
No need to tamper with quick connect seals upon application

## T75511 Power Steering Pump Pulley Set



Includes:

- Pulley Body, Center Bolt
- 2pc Jaws with Retaining Ring
- Bearing, Washer And Small Button
- Puller Pins for Quad 4, GM 3.1
- Installing Screws for Quad 4, GM 3.1, Ford 4.6 and Others

Removes and installs alternators and power steering pulleys on late GM, Ford and Chrysler engines. Reverse jaws pulls alternator internal bearings. Works readily without damaging pump or pulley.

Applications:

- 1988 to current GM Quad 4 engines
- 1990 to current Chevrolet Lumina APV, Pontiac TransSport, Oldsmobile Silhouette
- 1991 to current (3.1L V-6 engines) Chevrolet Lumina sedan, Oldsmobile Cutlass Supreme, Buick Regal, Pontiac Grand Prix
- 1991 to current Ford (4.6L engines)





### T75514 Water Pump Pulley Remover / Installer Set



Includes:

- Water pump pulley remover
- Thread protector
- Water pump pulley installer
- Thrust bearing for efficient installation

Makes the job of removing and installing water pump pulleys fast and simple. The pulley remover and pulley installer works smoothly, without leaving any damage to the pump or pump components. The pulley remover screws its bolts into the pump, binding the two parts for secure pulling. The pulley installer utilizes a thrust bearing which minimizes friction for faster and easier installation. Upon application, force is equally distributed between the pulley remover / installer for efficient and damage-free removal or installation. Functions with Cummins L10 and M11 engines.

### T75813 3pc Rear Axle Bearing Remover Set



- Extracts semi-floating rear axle bearings in most domestic vehicles
- Use with 5/8"-18 slide hammer for more torque and to avoid damage to rear axle or bearings
- Puller sizes: same as T75815 except with longer screws

### T75815 Rear Axle Bearing Puller Set



Includes: 3 Pulley Sizes:

- 1" minimum bearing tube I.D. and 1-7/8" maximum axle tube I.D.
- 1-5/16" minimum bearing tube I.D. and 2-3/8" maximum axle tube I.D.
- 1-3/8" minimum bearing tube I.D. and 2-7/8" maximum axle tube I.D.

Extracts semi-floating rear axle bearings of various diameters in most domestic cars. Three pullers quickly and efficiently pull bearings without inflicting damage on the rear axle or bearing. For more power, use with T75906 slide hammer.



## T75914 Universal Hub Puller



- Easily and quickly pulls wheel hubs without damaging wheel legs
- Adjustable sliding arms provides a straight pull
- Striking wrench and puller screws included

## T75939 Master FWD Wheel Bearing Adaptor Set



Complete set of 23 adaptors, collars and fittings for front wheel drive servicing. Designed to work with T75938 slide hammer puller and front hub remover. Works on both domestic and import front wheel drive vehicles as well as light trucks.

## T75948 Master Blind Bearing Puller Set



- Pulls blind hole bearings, bushings and sleeve with collets ranging from 3/8" to 1-1/4" where regular pullers will not reach
- Use with slide hammer with collets to pull bearings or bushings

## T75926 Industrial Harmonic Balancer Puller & Installer Set



- Includes:
  - 6pc - Cap Screws
  - 8pc - Adaptors
  - 1pc - 4 Slot Puller Plate
  - 1pc - Main Center Bolt

Removes and installs vibration dampers, balancers, pulleys and gears with tapped holes. Features heavy duty construction. Force is evenly distributed upon application. Tool can be used to pull out or install most objects since it works on either two or three tapped holes. Use with wrench for additional torque.

Application: Most domestic and import vehicles.



### T75941 Crank Shaft and Harmonic Balancer Holder - Honda



- Designed to work on camshaft pulley and harmonic balancer bolt removal
- Immobilize and secure pulley in place to avoid rotating when removes and installs crank bolt
- Works on 1990 and newer Honda Acura, Civic

### T75906 Slide Hammer Set



Extracts flange-type rear axles, semi-floating rear axle bearings, balancers, and other press-on parts. Also, with its 2/3" internal / external jaws it can remove gears, outer races, grease retainers, oil seals, and other internal / external pulling jobs. Operates on newer model cars and light trucks that have axles with bolts and studs no larger than 9/16" in diameter. Applies to 4.5, and 6 bolt stud circles that range from 4-1/4" and 5-9/16". The variety of attachments to the slide hammer make it a multi-functional puller set that can accomplish almost any task.

### T75920 Internal & External Bearing Puller Set



- Includes:
  - Slide Hammer (5/8" - 18 thread)
  - Two Internal 3-Jaw set (capacity 10 - 30mm, 30-80mm)
  - External 3-Jaw set (10 - 80mm), cone adaptor

Effectively removes internal and external bearing cups, seals, bushings, etc. Special cone adaptor is included for external pulling job which securely locks jaws on part to be removed.

Use with slide hammer (5/8" - 18 thread) for more torque.



## Bearing Separators



This device extracts bearings, double bearings, bearing cones and generator gears. Its curved, sharp edge maximizes the gripping surface area and locks the bearing in position. When space is limited, it can easily remove certain parts where the standard puller jaws cannot reach.

Available in 3 sizes:

Model	Capacity	Bolt diameter	Extension rod
<b>T75908</b>	30 - 50mm	3/8" x 24T x L120mm	3/8" x 16T
<b>T75909</b>	50 - 75mm	1/2" x 20T x L135mm	3/8" x 16P
<b>T75910</b>	75 - 105mm	5/8" x 18T x L165mm	M12 x 1.75P

### T75604 Pressure Screw Separator Puller Set



- Heavy duty construction puller set removes pressure screw with even applied force without damaging any parts
- Includes:
  - 1 - Bearing Separator (capacity 25 - 105mm)
  - 1 - Center Screw
  - 1 - Centering Adaptor
  - 1 - Twin Beam
  - 6 - 10" Rods
  - 1 - Extension Ram
  - 1 - Nut (Ram Part)

### T75907 Bearing Separator Assembly Kit



- Easily extracts bearings, double bearings, bearing cones and generator gears even in confined areas where standard puller jaws cannot reach
- Bearing separators curved, sharpened edge maximizes the gripping surface area and locks the bearing in position
- Push-puller secures its rods to the tapped holes of the bearing separator and pushes the object out
- Screw power enables a smooth, effective pulling force that completes the task, damage-free
- Bearing Separator - Chrome Molybdenum steel
- Contents:
  - Available in 3 sizes
  - Bearing Separator Capacity: 30 - 50mm
  - Bolt Diameter: 3/8" x L120mm x 24T
  - Bearing Separator Capacity: 50 - 75mm
  - Bolt Diameter: 1/2" x L135mm x 20T

### T75921 Hydraulic Gear Puller Set



- Heavy duty construction hydraulic puller set removes pressure screw with even applied force without damaging any parts
- Hydraulic ram included for labor saving
- Great application for agriculture machine, industry and garage use
- Contents:
  - Hydraulic Ram, Bearing Separator (75 - 150mm), Extension Rod (2), Main Rod (2), Ram Extension Rod (2), Pop, 4" Leg (3), 6" Leg (3), 8" Leg (3), Beam, Ram Nut, Twin Head, Triple Head





### T75949 Crankshaft Drive Belt Pulley Puller Set



- Universal puller to remove crankshaft drive belt pulleys with or without holes on European vehicles
- Ideal to work on confined areas

### T75609 Interchangeable Bearing Puller Set



- Includes:
  - 2 Pressure screws: 3/4" - 16 x 6-11/16", 3/4" - 16 x 5"
  - 2 Yokes - 2 and 3 pin holes per side
  - 2 Clamp bolts
  - 3 pairs puller jaws
  - 1 pair spring ball jaw pins
  - 3 pair capped screws
  - Spread: 3-1/4" to 5-1/2" and 2-3/8" to 3-3/8"
  - Reach: 1-5/8" and 1-3/4"

This convenient puller kit provides the versatility needed to handle myriads of pulling jobs. Effectively pulls alternators, generators, bearings, power steering and crankshaft pulleys, harmonic balancers and timing gears. Multi-hole yokes, adjustable clamp bolts, spring ball jaw pins and replaceable pressure screw points provide a safe, precise pull.

### T74100 Universal Puller Set



- Heat treated yoke for durability
- To remove bearings, gears and bushes from shaft
- Adjustable steel jaws
- Contents:
  - 3 - Puller arms (250mm)
  - 1 - 2 Arm beam
  - 1 - 3 Arm beam
  - 1 - Spindle

### T75881 Diesel Injector Puller



- Designed for easy and labor saving puller to remove stubborn BOSCH and LUCAS diesel injector.
- 3 adaptors included : M8, M12 and M14



### T70569 Coil Spring Compressor

- Compresses coil springs for strut services
- Heavy duty steel construction
- Suitable for most import and domestic passenger vehicle spring sizes



### T70570 Coil Spring Compressor

- Drop forged steel jaws
- Hardened alloy steel center bolts
- Compresses coil springs for strut services
- Suitable for passenger cars and light duty trucks
- Use with a 1/2" Dr. ratchet or 15/16" wrench



### T70573 MacPherson Strut Compressor

- Compresses MacPherson strut spring sets when replacing strut shock absorbers
- Heavy duty steel construction
- Can be used with hand or impact tools
- Fits most MacPherson struts and coil springs



### T75506 MacPherson Strut Coil Spring Compressor

- Designed to instantly compress and hold MacPherson strut coil springs for strut work servicing
- Universal fit, applying to all spring thicknesses
- U-bolts lock the spring into position, assuring a safe environment for operation
- Can be used with the GM W-Body Strut Service Kit (T75505)



### T75761 Coil Spring Compressor



This tool effectively removes and installs coil springs on all passenger cars and pickup trucks with removable shock absorbers. It works on all springs up to 5-5/8" outer diameter and can grasp any wire spring up to a diameter of 3/4". Applicable to both straight or curved springs

### T75762 MacPherson Strut Spring Hook Compressor Set



Efficiently compresses most MacPherson strut springs for shock absorber replacement. Designed with wide contact surfaces for variable coil sizes. Detent latch provides additional spring lock. Twin assembly allows rapid servicing by alternating from one set to the other.

#### Contents:

- 2 sets of heat-treated alloy thrust screws 5/8" x 11 x 12" with forged hooks



### T70126 Fin Straightener and Cleaner

- Cleans and straightens condenser and evaporator fins
- Multi 6-head tool handles: 8, 9, 10, 12, 14, 15 fins per inch



### T71190 UV Light Air Conditioning Leakage Tester

- Ideal for air conditioning leakage inspection
- High powered true UV LED technology
- Push button and turn switch for on and off power
- Uses 3 AA batteries (Not included)
- Insulated, flexible extension cable accesses hard to reach areas



### T73420 Automatic Coupler Set for R134a Manifolds



- Automotive quick coupler use with T75990 and T75992 on all R134a charge and service ports with various dimensions
- Easy to connect and disconnect, actuation valve for access to system even at working pressure.
- High pressure in red color with 14mm female thread
- Low pressure in blue color with 14mm female thread

### T75990 R134a Air Conditioning Manifold Gauge Set (Aluminum Body)



- High quality, extruded aluminum material for durability
- Includes:
- Aluminum manifold body with all necessary fittings
  - 2 easy-to-read, new silicone vibration-free gauges
  - 1 set of 60" hose -Yellow hose with 1/2 ACME x 1/2 ACME with quick seal valve
  - Red and blue hoses with 1/2 ACME x 14mm male thread
  - Automotive quick coupler-high pressure in red with 14mm female thread
  - Low pressure in blue with 14mm female thread

### T75992 R134a Air Conditioning Manifold Gauge Set (Brass Body)



- Includes:
- Brass manifold body with all necessary fittings
  - 2 easy-to-read, new silicon vibration-free gauges
  - 1 set of 60" hose - yellow hose with 1/2 ACME x 1/2 ACME with quick seal valve
  - Red and blue hoses with 1/2 ACME x 14mm male thread
  - Automotive quick coupler - High pressure in red with 14mm female thread
  - Low pressure in blue with 14mm female thread



### T70052 GM Heater Line Disconnect Tool

- Releases heater line quick connect fittings from engine block and thermostat housing
- Fits 1991 to current GM 3.1/3.4L and 3800 engines



### T75520 A/C Clutch Spanner Wrench

- Specially three stud design for GM compressors
- Adjustable brass thumbscrews
- Bright, plastic, non-slip handle



### T75551 Universal Radiator Pressure Test Kit



- Tests available radiator pressure
- Prevents radiator line leakages and replaces damaged parts

T75551-0 Temperature Thermometer

T75551-1 Pressure Testing Pump with Gauge

12 Adaptors:

T75551-2 Works on large trucks, GM

T75551-3 Works on Mercedes, Ford, GM, Jeep and large trucks

T75551-4 Works on Peugeot, Mitsubishi, Nissan, Mazda, Toyota, Subaru, Infiniti, GEO and Suzuki

T75551-5 Works on Honda, Toyota, Suzuki, Mitsubishi

T75551-6 Works on Opel, VW, Ford, BMW245, Saab and Jaguar

T75551-7 Works on Volvo, Saab, Audi, Citroen, Renault, Peugeot, Fiat, Alfa, and Jeep

T75551-8 Works on new VW

T75551-9 Works on VWT4, New Audi A4, A5, A6 and BMW345

T75551-10 Works on BMW

T75551-11 Works on Audi, VW

T75551-12 Works on Ford, International, GM and Rover

T75551-13 Works on Mercedes





### T70590 5pc 4" Auto Body Filler Applicators

- Flexible polypropylene body filler applicators ribbed for a secure grip
- Two fine edges for precise finishing work
- Radiused corners for concave, curve shaping



### T70600 Window Molding Remover

- Removes window molding clips on domestic cars and trucks



### T70602 Door / Window Handle Tool

- Easily removes spring clips from doors / handles
- Tapered jaws retain clips for easy re-installation
- Use raised end to remove upholstery



### T70604 Door / Window Clip Remover

- Removes / installs door handles and window clips
- Prevents damage to door panel upholstery
- Specially made for GM and Ford vehicles



### T70606 Door Upholstery Remover

- Easily removes plastic door upholstery clips
- Heavy duty steel shaft with large comfortable handle



### T70608 Door Pin Remover

- Removes and replaces door hinge pins on vehicles
- Includes 1 cranked handle and 3 punches
- Suitable for use on the following hinge pin sizes:
  - 5.5 mm (O.D.) 3.5mm (I.D.)
  - 6.5 mm (O.D.) 4.5mm (I.D.)
  - 7.5 mm (O.D.) 5.5mm (I.D.)



### T70615 3-in-1 Auto Spring Remover

- Removes door rubber securing clips, plastic clips, door handle clips, and head light springs
- Manufactured from tempered spring steel



### T70643 Universal Lift Support Clamp

- Works on vehicles with weak gas cylinder lifts on hoods, tailgates, and trunks
- Adjustable knob securely holds weak lift supports in the extended position to allow access in the engine compartment or luggage areas





### T70646 CV Joint Boot Clamp Pliers

- Specially designed tips service boot clamps on CV joints on many foreign and domestic cars



### T70647 CV Boot Clamp Pliers

- Crimps and flattens ear-type clamps found on CV joint boots
- Installs quick clamps on fuel filter and cooling system hoses



### T70654 CV Boot Clamp Pliers

- To crimp all ear-type boot clamps on most vehicles
- Use with 1/2" extension or torque wrench
- Works on Audi, BMW, Ford, GM, Chrysler, Honda, Mazda, Mercedes, Nissan, Opel / Vauxhall, VW



### T70648 Offset Boot Clamp Pliers

- Designed to crimp ear-type boot clamps
- Offset jaws works on large boot clamps
- Excellent for working in confined spaces



### T70655 Heavy Duty CV Boot Clamp Pliers

- Heavy duty construction for durability
- To assemble new stainless steel clamp bands on drive shaft that requires torque setting
- Ideal to use with 3/8" Dr. torque wrench



### T70650 CV Joint Clamp Banding Tool

- Easily and conveniently bands CV joint clamps
- Heavy duty tempered steel
- Vinyl handle for secure grip



### T70652 CV Joint Clamp Banding Tool with Snip

- Easily and conveniently bands CV joint clamps
- Heavy duty tempered steel
- Built-in cutting arm snips band after tightening



### T70640 Windshield Molding Door Handle Tool

- Releases windshield molding clips, door handles, and window crank retaining clips
- Non-slip vinyl offset handle permits easy access to molding clips
- Slips under window crank without damage to panel material





### T70609 Clip Removal Pliers

- Removes door upholstery and other trim items anchors
- 2-step tip allows easy access to deep under clip heads to prevent slippage
- Spring loaded handle for a great leverage



### T70660 Windshield Removal Tool

- Cuts windshield seal for quick windshield removal
- Insert cutter under windshield and through the seal
- Use "T" handle to pull the cutter and cut the seal
- Cuts through all windshield adhesives



### T70620 Windscreen Wiper Arm removal tool

- To remove wiper arm without damage the wiper
- Easy access and work in confined area
- Size: 16mm x 46mm

### T70621 Size: 26mm x 42mm



### T70663 Car Door Lock-Out Tool

- Emergency access when keys are locked inside vehicle
- Size 1-1/4" x 24" with push and pull ends



### T70701 Windshield Removal Tool



Comprehensive 5pc kit simplifies the removal or release of bonded windshields, windshield molding, butyl adhesive compound and trim pads.

Contents:

- Triple-braid, galvanized steel wire with two gripping handles
- Windshield Removal Tool
- Wire Feeder Tool
- Trim Pad Remover
- Windshield Molding Release Tool

### T70706 10-in-1 Trim Tool



- Multi-purpose panelbeating tool for removing and installing auto trim fittings & fixtures. Tempered spring steel.

Includes :

- 1 Headlamp spring tool
- 2 Windshield molding clip remover
- 3 Door rubber plastic clip remover
- 4 Serrated edge for panel seam detail neatening
- 5 Molding remover
- 6 Windshield wiper wrench
- 7 Door rubber metal clip inserter
- 8 Door weather strip clip remover
- 9 Door handle clip remover
- 10 Door trim bezel clip remover



## T70665 17pc Deluxe Lock-Out Tool Set



Includes:

- Buttoneer & Auxiliary tool
- Slide Locks & Zingers tool
- Camry & Chrysler tool
- Mercedes & Volvo tool
- Dual Tool
- Japan Easy Button Hook
- Porsche tool
- Astro & Camaro tool
- Thin Bar tool
- Knob Knabber tool
- Wide Bar tool
- Wonder tool (integrated unit)
- Polypropylene Window Wedge
- Universal Angle Hook tool (Button Pull)
- Universal Radiused Hook tool (Double Curve)
- Gas Filler Cap Lock Master Keys x 2

The professional solution for lock-out situations. Conveniently stored in a carry case for call outs. Each tool is clearly labeled & secured. The tools are carefully manufactured from specially selected materials that allow the user to bend or shape the tools for the required application. Most of the tools are produced from 430 grade stainless steel, with the exception of the Knob Knabber, Window Wedge & Chrome plated mild steel Wonder Tool. Detailed manufacturers reference guide and instruction booklet are included.

## T70675 4" Retractable Safety Scraper

- Retractable blade for safety and storage
- Chrome plated finish resists corrosion
- Includes 5 single-edge razor blades



## T70677 Heavy Duty Gasket Scraper

- Durable alloy steel
- 1" flat scraper blade for scraping surfaces before installing gaskets



## T70676 All Purpose Scraper

- Removes stickers, tape, paint and putty from glass, porcelain and steel
- 3 lock positions reach many areas
- Protective handle for safe blade storage



## T70678 Extended Scraper

- Removes stickers from windshields and bumpers
- Spring release changes blades
- Stores 2 extra steel blades and 3 plastic blades in handle







### T70681 10pc Razor Blade Set

- Standard single-edge blades
- Each set packaged in 2 boxes, 5 blades per box



### T70682 100pc Razor Blade Set

- Standard single-edge blades
- Packaged in 100 blades per box



### T70708 Angle Tip Lock Ring Pliers

- Removes and installs all types of lock rings on brakes, transmissions, cylinders, clutches, shafts and other applications
- Serrated jaws and angled tips for secure grip



### T70714 2pc O-Ring Hook and Scribe Set

- Both tools facilitate easy removal and installation of O-rings and seals
- Can also be used to retrieve small items
- Knurled handle for sure grip



### T73762 Steering Wheel Lock Plate Tool

- Removes lock rings from steering wheel
- Includes metric M14 and standard 9/16" x 18 adaptors
- Fits many domestic car steering wheels and lock plates



### T73766 Steering Wheel Lock Plate Remover

- Removes steering wheel lock plates from most vehicles with tilt and telescoping columns
- Designed for air bag equipped vehicles
- Includes 9/16" x 18" and M14 x 1.5mm adaptors



### T73763 Air Bag Release Tool - GM

- Quick release retention springs for removal of steering wheel air bag on GM vehicles
- Works on Buick, Cadillac, Chevrolet, Pontiac, light trucks and mini vans



### T73904 Steering Wheel Puller

- Pulls steering wheels on most domestic and import vehicles
- Heavy duty durable construction





### T75513 Steering Wheel Puller / Lock Plate Compressor Set



Includes:

- Steering wheel puller
- Lock plate compressor

Everything you need to remove steering wheels on almost all vehicles with conventional or tilt steering columns. The steering wheel puller features 5 sets of cap screws that securely fasten to steering wheels on many different vehicles including the Chevrolet Lumina, Pontiac Grand Prix, Oldsmobile Cutlass Supreme, Buick Regal, and any other automobile with a redundant entertainment / climate control circuit board. The lock plate compressor accesses the turn signal switch and S.I.R. modules on Chrysler, GM, and AMC to compress the steering wheel in order to remove / install the snap ring. Both the lock plate compressor and steering wheel puller make excellent use of screw power to complete the job efficiently without damaging the steering wheel or steering wheel components.

### T75533 Air Bag Removal Tool



- Removes driver air bag from steering wheel on most vehicles
- Works on newer models of Mercedes, BMW, VW

### T75902 12Lb Dent Puller Set



- Quickly removes dents for auto body repair work without having to extract vehicle's inside panels and upholsteries
- Heavy duty parts construction for strength and durability
- 12 lb square hammer design prevents rolling away out of reach
- Variety of tapered attachments easily pulls dented or creased sheet metals back into place
- Solid 5/8" slide shaft allows space to pull hammer, resulting in a powerful pulling force in hard-to-reach dented areas such as door panels, side panels, fenders and roof

### T75905 9pc 10Lb Dent Puller Set



This tool quickly removes dents for auto body repair work without having to extract vehicle's inside panels and upholsteries. A 10 pound slide hammer and a variety of tapered attachments easily pulls dented or creased sheet metals back into place. The long shaft allows more space to pull the hammer, therefore resulting in a powerful pulling force in hard-to-reach dented areas such as door panels, side panels, fenders and roof.



### T70711 All Purpose Awl

- Scribes, aligns and punches holes in light metal
- Perfect for tire repair
- Heat-treated, tapered shank



### T70712 Offset Pick Tool

- Distinctive offset shaft and curved end help to reach over the pin weld and easily grab the lip of the rubber
- Heat-treated carbon steel
- Rubber handle for secure grip
- Blade length: 115mm (4-1/2")



### T70715 2pc Rubber Ring Hook Tool Set

- Special angle hook design to pull rubber rings connected to exhaust tube

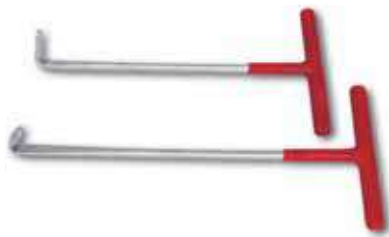

### T70736 4pc Pick Set

- Complete scribe and hook set for pin pulling, picking O-rings, etc.
- Durable, heat-treated steel
- Curved hook, Offset 45-degree hook, 90-degree hook, Straight pick



### T70737 8pc Mini Pick and Driver Set



- Removes and replaces seals, O-rings, nuts, clips, springs, pins, washers, etc.
- Chrome Vanadium steel
- Contents:
 

1 - Curved Hook	1 - Offset 45° Hook
1 - 90° Hook	1 - Straight Pick
4 - Screwdrivers:	
1 - Slotted: 1/8",	
1 - Phillips: #0	
2 - Star: T15, T20	

### T70918 3" Wheel Brush

- Removes metal burrs, scratches, rust, carbon, scales, stains and dirt
- 3" diameter, 1/4" steel shank
- Max. safe free speed 4,500 RPM



### T70931 Stem Mounted Knotted End Brush

- Removes heavy carbon deposits and corrosion
- Twist knot construction for the most challenging applications
- 1" diameter, 1/4" steel shanks
- Max safe speed 20,000 RPM





### T70932 Steel Wire Cup Brush

- Removes metal burrs, scratches, rust, carbon, scales, stains and dirt
- 2-1/2" Diameter, 1/4" steel shank
- Maximum safe free speed 4,500 RPM



### T70933 Stem Mounted End Brush

- Removes carbon deposits on piston heads, cylinders, and valve seats
- Use with 1/4" electric drills
- 1" diameter, 1/4" steel shanks
- Maximum safe free speed 20,000 RPM



### T70962 Utility Wire Brush

- Cleans carbon, paint and dirt from metal surfaces
- Durable, tempered steel bristles
- 3 x 19 rows of 1-1/4" long bristles



### T71001 Nylon Parts Cleaning Brush

- Tough polypropylene bristled brush resistant to oil, gasoline, turpentine and other cleaning solvents
- 2-1/2" Chisel trimmed bristles



### T73785 Single Suction Cup



- Lifts, adjusts and positions windshield glass, sheet metal, sheet plastic and glazed items
- Pulls out panel dents with easy one-hand operation

### T73791 Heavy Duty Double Suction Lifter Set



- Lifts, adjusts and positions windshield glass, sheet metal, plastic and glazed items
- Heavy duty construction with swivel heads for curved car windshields





### T71031 Battery Carrier

- Safe, secure and adjustable battery carrier
- Rugged and grooved rubber pads provide better grip and avoid damage to casing
- Adjustable for both post, side terminal, 6 and 12 volt batteries



### T71032 Belt Type Battery Carrier

- Designed to easily carry 6 and 12 volt post or side terminal batteries
- Serrated jaws with acid-resistant insulated strap for secure grip

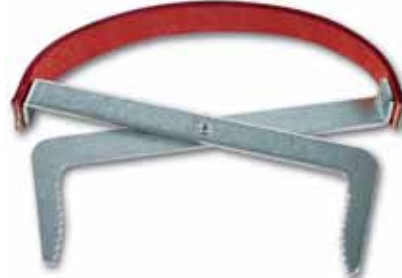

### T71046 Battery Terminal & Bearing Puller

- Removes corroded terminals without damage to battery posts or case.
- Sharp jaws easily grip terminal
- Center screw effectively removes alternator bearings



### T71066 Side Terminal Battery Wrench

- Removes and replaces 5/16" GM side terminal battery fittings
- Reversible 5/16" ratcheting box design



### T71068 Terminal Release Tools

- Special 12 blade design releases terminals from plastic connectors without damaging connectors or computer components
- Works on most GM, Ford, Chrysler, domestic and imported vehicles



### T71091 Battery Tester

- Number of floating balls indicate battery condition
- Use to test 6, 12 and 24 volt batteries



### T71092 Professional Battery Tester

- Easy-to-read, color-coded float indicates battery charge
- Rubber bulb and acid-resistant rubber tip



### T71093 Deluxe Battery Tester

- Quickly and accurately indicates battery charge level without charts or color-coded scales
- Tests all 6, 12 and 24 volt systems





### T71094 Professional Battery Tester

- Easy-to-read, color-coded float indicates battery charge
- Temperature gauge for accurate readings in warm or cold conditions
- Rubber bulb and acid-resistant rubber tip



### T71131 Digital Multi - Tester

- Compact design, 3 digit LCD readout
- Measures DC and AC voltage and amperage
- Multi-testers for cars, home wiring and appliances



### T71140 Battery / Alternator Voltage Tester

- Checks 12 volt battery and alternator systems
- LED light for easy and accurate reading



### T71151 Heavy Duty Circuit Tester

- Heavily reinforced components for lifetime use
- Strain relief spring takes pressure off chord end
- Tests 6, 12 and 24 volt systems
- Tests for shortages in wiring, connectors, fuses and switches in automotive electrical systems



### T71164 Hi-Lo Circuit Tester

- Checks all 6 and 12 volt circuits
- Checks spark plugs on secondary or high voltage circuits
- Extra long 48" leads



### T71176 Circuit Sounder

- Uses flashing lights and buzzer sounds to check 6, 12 and 24 volt circuits
- Tests for shortages in wiring, connectors, fuses, and switches in automotive electrical systems
- Perfect for under bright light or confined areas



### T71180 Replacement Bulbs

- Two (2) replacement 6, 12, 24 volt bulbs
- For use with T71151, T71182 testers



### T71181 Replacement Bulbs

- Two (2) replacement 6, 12, 24 volt bulbs
- Use with T71185 tester





### T71182 Circuit Tester

- Checks 6, 12 and 24 volt circuits
- Tests for shortages in wiring, connectors, fuses, and switches in automotive electrical systems
- Extra long 48" leads



### T71185 Continuity Tester

- Checks circuits, voltage regulators, fuses, switches, armatures, distributors, etc.
- Self-powered by AA 1.5V battery (battery not included)
- Extra long 48" leads



### T71186 Testing Screwdriver 150-250V

- Slotted screwdriver design tester with visual indicator
- 3.5mm x 190mm



### T71187 Testing Screwdriver 220-250V

- Slotted screwdriver design tester with visual indicator
- 3.0mm x 140mm



### T75705 Optical Fluid Tester

- Visually tests specific battery acid gravity to check battery condition
- Also checks frost protection level of engine coolant & washer fluid composition (Propylene, ethylene & latest G11, G12 & G13 coolants used in import vehicles)



### T71055 Battery Post and Terminal Brush

- Quickly cleans terminal corrosion and dirt from battery cable clamps for better contact
- Metal case protects brush against grounding



### T71063 Battery Post and Terminal Cleaner

- Cleans and reams battery posts and terminals
- Post cleaners marked with positive and negative signs for easy identification



### T71075 Auto Cigarette Socket Adaptor

- Heavy duty extension cord with socket fitting
- Designed for easy under-hood testing of 12 volt electrical equipment with recessed socket terminals





### T71209 Remote Starter Switch

- Starts or jogs engine from remote locations with no need to climb back into car
- Heavy gauge, rubber covered copper wire
- Five-foot leads



### T71240 High Energy Ignition Spark Tester

- Measures standard, electronic or DIS kV
- Designed to determine coil voltages and prevent high energy sparks from leaking



### T71242 High Energy Ignition Spark Tester

- Checks spark in ignition systems without removing spark plug from engine



### T71205 Spark Plug Wire Puller

- Easily and safely pulls spark plug wire without damage to wire or rubber boots
- Insulated nylon handle protects hands from shocks, heat and burns



### T71206 Spark Plug Wire Puller

- Simply and effectively disengages spark plug wire boots from plugs
- Perfect for hard-to-reach or recessed plugs
- Insulated plastic handle for safety



### T71222 Spark Plug Wire Pliers

- Insulated plier jaws and handles safely remove spark plug wire boots
- Offset serrated jaws perfect for accessing hard-to-reach boots



### T71245 Spark Plug Remover / Installer

- Flexible shaft easily accesses tight areas
- Removes and installs spark plugs at any angle without cross threading
- Soft, stepped tip grabs plug terminals and porcelain insulator securely
- Non-slip handle for sure grip



### T71252 Heavy Duty Spark Plug Boot Pliers

- 45-Degree offset vinyl coated jaws to ensure complete coverage of all contact areas
- Non-slip, vinyl coated handles
- Use only on automotive type ignition systems







### T71253 Spark Plug Pliers



- 45-Degree offset jaws
- Designed to remove spark plug boots without pulling the plug lead from its clip
- Double insulated jaws for protection against shock and complete coverage on all contact areas
- Angled nose gives easy access to plug boot

### T75703 Spark Plug Wire Tester

- Quickly locates damaged parts of spark plug wires without damaging wire
- Slide tester along wire until light stops flashing to locate insulation leakage and core damage
- Eliminates shock hazard



### T75701 Extended Spark Plug Socket

- Heat-treated alloy steel
- Removes hard-to-reach recessed spark plugs
- Knurled barrel for better grip
- 3/8" Dr. x 5/8" spark plug socket
- Fits both modern and older vehicles



### T71259 2pc Ignition Point File Set

- High quality steel, fine grit on both sides
- Cross-cut file pattern
- Ideal for filing spark plug and distributor ignition points



### T71265 Ignition Module Wrench

- Removes ignition module from distributor on Ford vehicles
- Features T20 star bit and 7/32" hex
- Knurled knob for one-hand turn or use 1/2" wrench for extra torque



### T71266 Ford Ignition Module Wrench

- Removes 7/32" hex retaining bolts on Ford ignition modules
- Use with 1/2" Dr. wrench for extra torque



### T71317 Ford Radio Removal Tool

- Efficiently releases radio retaining clips and also functions as convenient pull handles
- Fast, efficient and damage-free to radio or dashboard housing
- Use on most 1987 to current Ford cars and trucks





### T75704 Re-Threader Kit for 14mm Spark Plugs



- Effectively repairs damaged 14mm spark plug threads in aluminum cylinder heads
- Solid steel inserts and reamer / tap ensure positive new clean threads
- Includes: Tap and reamer and 4 inserts
- Insert sizes: 3/8", 7/16", 1/2", and 3/4"

### T71292 Spark Plug Hole Thread Chasers



- Cleans any standard deep socket thread from dirt, carbon buildup and metal particles
- Hexagonal section with neoprene bands
- End specially shaped for easy starting

<b>T71292</b>	14mm
<b>T71293</b>	14 & 18mm
<b>T71294</b>	10 & 14mm

### T75911 Antenna & Radio Service Set



Includes:

Antenna wrench, Chrysler radio removal socket, Ford radio removal tool, GM code retriever, offset bit ratchet handle, T10, T15 star bit, and tamper resist star bits - T7, T10 and T15

- Most popular tools to remove and install bezel nuts on antennas, radio retaining clips, etc on Ford, GM, Chrysler, VW and Toyota vehicles

### T71268 44pc Radio Removal Tool Set



- Set includes the following tools needed to install and remove radios:
  - 2 - Radio Removal U-Hook (Ford / VW / Audi / Grundig / Blaupunkt)
  - 1 - Special Pentagon Wrench (BMW)
  - 4 - Radio Removal Keys (VW / Audi / Becker / Mercedes-Benz)
  - 2 - Radio Removal Keys (Mercedes Benz / Porsche / Becker)
  - 2 - Radio Removal Keys (VW)
  - 1 - Allen Hex Wrench (BMW / Opel)
  - 2 - Radio Removal U-Hook (New Blaupunkt)
  - 6 - Radio Removal Keys (Mercedes Benz & BMW)
  - 2 - Radio Removal Keys (Kenwood II 1998-2001)
  - 2 - Radio Removal Keys (Sony II ab 2002)
  - 2 - Radio Removal Keys (Kenwood III ab 2002)
  - 2 - Radio Removal Keys (Pioneer & JVC)
  - 2 - Radio Removal Keys (Sony I bis 2001)
  - 2 - Radio Removal Keys (Panasonic)
  - 2 - Radio Removal Keys (Kenwood I bis 1998)
  - 2 - Radio Removal Keys (Kenwood Mask)
  - 2 - Radio Removal Keys (Clarion-New)
  - 2 - Radio Removal Keys (Clarion)
  - 2 - Radio Removal Keys (Panasonic 2006)
  - 2 - Radio Removal Keys (Sony idic 2005)



### T71405 Terminal Clamp Spreader

- Simultaneously spreads and cleans battery clamps
- Heat-treated, forged steel
- Deluxe handle for a secure grip



### T75702 Auto Computer Memory Unit

- Retains memory of digital car radios, clocks and computer functions when battery is disconnected
- Use with 9-volt battery (not included)
- Keeps settings up to 4 hours



### T75775 10pc Noid Light & IAC Signal Tester Set



- Noid lights provide the most efficient way to check electronic fuel injection (EFI) signals
- Idle or control (IAC) tester checks electronic control signal on GM vehicles with throttle body or port fuel injection systems
- Includes:
  - 8 - Noid-Light: Bosch PFI, Bosch 2, GM PFI, GM TBI, GM SCPI, Ford TBI, Geo TBI, GM Multec2
  - 2 - IAC Tester Light - Flat 4 Pin Connector, Square 4 Pin Connector

### T75776 6pc Noid Light Set



- Most economical way to check electronic fuel injection (EFI) signals
- Quick and easy operation. Simply disconnect fuel injectors and plug the Noid Lite into the injector wiring harness
- When engine is cranked, normal signals are indicated in rapid flashes of the Noid Lite. Either a constant light or no light at all confirms an EFI signal problem

Checks systems of:

Bosch PFI, GM PFI, GM TBI, GM SCPI, Ford TBI, Geo TBI

### T71295 Oxygen Sensor Thread Tool

- Cleans oxygen sensor threads
- Use with 3/4" hex socket or 3/8" sq. dr. handle
- Works on M18 x 1.5 spark plug threads



### T71246 Ignition Coils Puller - VW, Audi

- Easily removes ignition coil from fuel injection engines found on VW and Audi
- The front hook removes ignition coil without damage
- Works on VW Bora, Golf, Beetle, Passat, Polo, Touran 1.4/1.6L, Lupo 4-yl, FSI, Phaeton, and T4, BBY, BKY 1.4





### T71247 Ignition Coils Puller - VW, Audi

- Easily removes ignition coil from fuel injection engines found on VW and Audi
- Front hook removes ignition coil without damage
- Works on VW Bora, Golf, Passat, Sharan, Touareg, R32, Phaeton, and T5, V5 2.3, V3.2



### T71248 Ignition Coils Puller - VW, Audi

- Easily removes ignition coil from fuel injection engines found on VW and Audi
- Front hook removes ignition coil without damage
- Works on VW 8 and 12 cylinder engines, Phaeton, B5, 1.8T, GTI, FSI 2.0



### T71249 Ignition Coils Puller - VW, Audi

- Easily removes ignition coil from fuel injection engines found on VW and Audi
- Front hook removes ignition coil without damage
- Works on most VW, Audi injection engines



### T71255 Offset Distributor Clamp Wrench

- Adjusts distributor bolt while adjusting engine timing
- Two offset box wrenches: 1/2" and 9/16"
- Chrome plated finish



### T71301 Carburetor Adjusting Tool



- Adjusts idle screws on GM and Chrysler vehicles
- Includes four adaptors: 4.5mm, 1/4" hex sockets, "Double D" socket and 3/32" hex bit
- Heavy duty flexible shaft
- Adaptors store in handle or boot

### T75709 23pc Terminal Release Tool



- Custom designed to release terminals from wiring connectors without damage to component
- Works on most vehicles





## T75710 Dashboard Service Tool Kit - Mercedes Benz



- Complete parts to service dashboard for Mercedes series
- Contents:
  - 2 - Ignition Lock Remover - Model W124, W201
  - 2 - Ignition Lock Remover - Model W126
  - 2 - Instrument Cluster Removing Hooks - Model W107, W116, W123, W124, W126, W140, W201
  - 4 - Radio Set Remover - Model W129, W140, W202, W210

## T75900 4pc Ignition Coils Puller Set



- Use for VW Bora, Golf, New Beetle, Passat, Polo, Touran 1.4/1.6l, Lupo 4-Zyl. Fsi, Phaeton and T4, Bby. Bky 1.4.
- Use for VW Bora, Golf, Passat, Sharan, Touareg, R32, Phaeton and T5, V5 2.3, V6 3.2.
- Use for VW 8-and 12 Cylinder Engines e.g. Phaeton, B5 1.8t, Gti. Fsi 2.0

## T71069 12pc Universal Terminal Release Tool Set



- Quick and easy professional repair of malfunctions due to loose contacts
- Basic set of most plug-type connections for damage-free releasing of plug-type connectors
- Two-tone color handle with protective blade cap
- Application: Ford, BMW, Mercedes-Benz, Opel, Volkswagen, Fiat, Man, SAAB, Renault, Diamler-Chrysler, Porsche, PSA, Skoda, Audi, Mazda, Toyota



### T71320 Feeler Gauge- 13 Blades

- Hardened, tempered high quality steel blades
- Permanently marked in standard and metric sizes
- Knurled locknut for easy blade selection



Inch	mm	Inch	mm
0.002"	0.05	0.020"	0.50
0.004"	0.10	0.024"	0.60
0.006"	0.15	0.028"	0.70
0.008"	0.20	0.032"	0.80
0.010"	0.25	0.035"	0.90
0.012"	0.30	0.040"	1.00
0.016"	0.40		

### T71321 Feeler Gauge - 32 Blades

- 32 straight blades
- 0.010 brass blade for ignition
- Decimal and metric sizes



Inch	mm	Inch	mm	Inch	mm
0.0015"	0.04	0.014"	0.35	0.030"	0.75
0.002"	0.05	0.015"	0.38	0.032"	0.80
0.0025"	0.06	0.016"	0.40	0.035"	0.88
0.003"	0.08	0.017"	0.43		
0.004"	0.10	0.018"	0.45		
0.005"	0.13	0.019"	0.48		
0.006"	0.15	0.020"	0.50		
0.007"	0.18	0.021"	0.53		
0.008"	0.20	0.022"	0.55		
0.009"	0.23	0.023"	0.58		
0.010"	0.25	0.024"	0.60		
0.011"	0.28	0.025"	0.63		
0.012"	0.30	0.026"	0.65		
0.013"	0.33	0.028"	0.70		

#### Brass Blades

Inch	mm
0.010"	.254

### T71322 Feeler Gauge - 20 Blade

- Hardened, tempered high quality steel blades
- Permanently marked in standard and metric sizes
- Knurled locknut for easy blade selection



Inch	mm	Inch	mm
0.002"	0.05	0.024"	0.60
0.004"	0.10	0.026"	0.65
0.006"	0.15	0.028"	0.70
0.008"	0.20	0.030"	0.75
0.010"	0.25	0.032"	0.80
0.012"	0.30	0.033"	0.85
0.014"	0.35	0.035"	0.90
0.016"	0.40	0.037"	0.95
0.018"	0.45	0.040"	1.00
0.020"	0.50		
0.022"	0.55		

### T71324 Feeler Gauge - 26 Blades

- Hardened, tempered high quality steel blades
- Permanently marked in standard and metric sizes
- Knurled locknut for easy blade selection



Inch	mm	Inch	mm
0.0015"	0.04	0.015"	0.38
0.002"	0.05	0.016"	0.40
0.0025"	0.06	0.017"	0.43
0.003"	0.08	0.018"	0.45
0.004"	0.10	0.019"	0.48
0.005"	0.13	0.020"	0.50
0.006"	0.15	0.021"	0.53
0.007"	0.18	0.022"	0.55
0.008"	0.20	0.023"	0.58
0.009"	0.23	0.024"	0.60
0.010"	0.25	0.025"	0.63
0.011"	0.28		
0.012"	0.30		
0.013"	0.33		
0.014"	0.35		



### T71328 Ignition Gauge - 16 Blades

- Hardened, tempered high quality steel blades
- Permanently marked in standard and metric sizes
- Knurled locknut for easy blade selection



Inch	mm	Inch	mm
0.011"	0.279	0.020"	0.508
0.012"	0.305	0.022"	0.559
0.013"	0.330	0.024"	0.610
0.014"	0.356	0.025"	0.635
0.015"	0.381	0.028"	0.711
0.016"	0.408	0.030"	0.762
0.017"	0.432	0.032"	0.813
0.018"	0.457		
0.019"	0.483		

### T71334 Tune-Up Gauge - 18 Blades & 6 Wires

- Hardened, tempered high quality steel blades
- Permanently marked in standard and metric sizes
- Knurled locknut for easy blade selection



Wires:		Brass Blades:		Steel Blades:			
Inch	mm	Inch	mm	Inch	mm	Inch	mm
0.025"	.635	0.006"	.152	0.010"	.254	0.019"	.483
0.030"	.762	0.008"	.203	0.012"	.305	0.020"	.508
0.034"	.864	0.010"	.254	0.015"	.381	0.022"	.559
0.035"	.889	0.012"	.305	0.016"	.406	0.024"	.610
0.040"	1.02	0.014"	.356	0.017"	.432	0.025"	.635
0.045"	1.14	0.016"	.406	0.018"	.457	0.026"	.660

### T71340 Tappet & Ignition Gauge - 18 Blades

- Hardened, tempered high quality steel blades
- Permanently marked in standard and metric sizes
- Knurled locknut for easy blade selection



Tappet Blades:		Ignition Blades:	
Inch	mm	Inch	mm
0.004"	.102	0.012"	.305
0.005"	.127	0.015"	.381
0.006"	.152	0.018"	.457
0.007"	.178	0.020"	.508
0.008"	.203	0.022"	.559
0.009"	.229	0.025"	.635
0.010"	.254	0.030"	.762
0.012"	.305	0.040"	1.02
0.013"	.330		
0.015"	.381		

### T71336 Tappet Gauge - 12 Blades

- Hardened, tempered high quality steel blades
- 45-Degree offset blades for easy access
- Permanently marked in standard and metric sizes
- Knurled locknut for easy blade selection



Inch	mm	Inch	mm
0.008"	.203	0.016"	.406
0.010"	.254	0.018"	.457
0.012"	.305	0.019"	.483
0.013"	.330	0.020"	.508
0.014"	.356	0.025"	.635
0.015"	.381	0.026"	.660



### T71436 Non-Magnetic Brass Gauge

- 6 Brass blades
- Stamped with decimal and metric equivalents

Inch	mm
0.006"	.152
0.008"	.203
0.010"	.254
0.012"	.305
0.014"	.356
0.016"	.406



### T71460 Spark Plug Gauge

- Pocket size gauge for adjusting spark plug electrodes and gaps of high-energy ignition systems
- Includes 2 electrode adjusting tools

Inch	mm
0.040"	1.02
0.044"	1.12
0.045"	1.14
0.050"	1.27
0.060"	1.52
0.080"	2.03



### T71465 Key Chain Spark Plug Gauge

- Pocket-sized, spark plug gauge with key-chain hole
- Marked in SAE and metric sizes
- From .020" to .100"



### T71466 Spark Plug Gauge Display Stand

- Heavy duty construction
- Each stand holds 25pc spark plug gap gauges



### T71467 25pc Gap Gauge with Stand



- Convenient, stable gap gauge holder
- Keeps gap gauges organized & prevents loss
- Stores up to 25 gauges (T71465)

### T75715 Rechargeable Jump Start System



- Portable jump starting power for repeat starts
- Integral, heavy duty booster cables & crocodile clamps
- Recharges via supplied 110v AC transformer
- 5 Level charge display, 10 amp safety fuse
- Also powers other DC applications: vehicle accessories, camping equipment, entertainment, communications and lighting equipment
- Twin 12 volt DC inlet and outlet ports





### T71578 Brake Adjustment Tool

- Quickly adjusts star wheel brakes on most GM vehicles
- Chrome plated finish resists corrosion
- Offset angle designed to reach confined areas



### T71581 Brake Spoon - 7"

- Allows quick brake adjustments
- Chrome plated finish resists corrosion
- Double-ended spoon tips access hard-to-reach areas



### T71584 Brake Spoon - 9"

- Allows quick brake adjustments
- Chrome plated finish resists corrosion
- Offset angle ends provide leverage in confined areas



### T71605 Brake Spring Tool

- Removes and installs return springs on Bendix brakes
- Offset design for extra maneuverability



### T71600 Brake Bleeder Wrench



- Drop forged, heat-treated steel
- Bleeds air from brake cylinders by loosening brake bleeder screws
- Double-ended offset design to reach confined areas

**T71600** 5/16" x 3/8"

**T71601** 1/4" x 3/8"

**T71602** 8mm x 10mm

**T71603** 7mm x 9mm

### T71607 Brake Spring Tool

- Removes and installs return springs on imported car brakes
- Can also be used on domestic car brakes that do not use anchor pins



### T71609 Brake Spring Compressor

- Removes and installs brake spring washers from 5/8" to 7/8" in diameter





### T71610 Brake Spring Compressor

- Removes and installs brake spring washers from 5/8" to 11/16" in diameter
- Fits late model compact cars and light trucks



### T71622 Brake Spring Compressor

- Removes and installs back plate springs, clips & pins
- Zinc plated to resist corrosion



### T71611 Brake Spring Pliers

- Removes and installs brake springs
- Chrome plated finish resists corrosion
- Double-ended design



### T71614 Brake Spring pliers

- Removes and installs return springs
- Works on drum brakes of domestic and imported vehicles
- Handle provides socket-type spring remover and hook-end replacer



### T71633 3/8" GM Disc Brake Caliper Wrench

### T71634 8mm Disc Brake Caliper Wrench

- Alloy steel, "Allen" type wrench
- Removes and installs brake caliper mounting bolts on cars
- 3/8" type hex wrench



### T71709 3/8" Dr. Disk Brake Caliper Star Bit Sockets

- Heat-treated, alloy steel, S2 bits
- Removes and installs brake caliper mounting bolts on Ford and GM cars
- Contents: T40, T45, T50



### 3/8" Dr. Disk Brake Caliper Hex Bits



- Removes and installs brake caliper mounting bolts on newer domestic and imported cars
- Heat-treated, alloy steel, S2 bits

### T71731 3pc Set: 1/4", 5/16", 3/8"

### T71732 4pc Set: 1/4", 5/16", 3/8", 7/32"

### T71733 3pc Set: 7, 8, 10mm



### T71785 Brake Cylinder Hone

- Flexible shaft for easy use and self-centering
- Knurled nut controls honing tension
- 27/32" through 2" range



### T71791 Brake Cylinder Hone

- Flexible shaft for easy use and self-centering
- Knurled nut controls honing tension
- 3/4" through 2-1/2" range



### T71797 Brake Cylinder Hone

- Flexible shaft for easy use and self-centering
- Knurled nut controls honing tension
- 1-1/4" through 3-1/2" range



### T71803 Brake Cylinder Hone

- Flexible shaft for easy use and self-centering
- Knurled nut controls honing tension
- 11/16" through 2-1/2" range



### Replacement Stones for Cylinder Hones

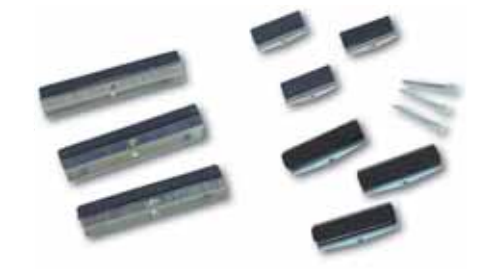

### T71792 3pc 1-1/8" Replacement Medium Stone Set

- Use with T71791

### T71798 3pc 2" Replacement Medium Stone Set

- Use with T71797

### T71804 2pc 1-1/8" Replacement Medium Stone Set

- Use with T71803

### T71664 Brake Bleeder Hose

- Simple one man brake bleeding operation
- Neoprene hose with steel coupling



### T71652 Bleed-O-Matic Brake Bleeder

- Allows one person to quickly bleed brakes
- Plastic cup collects discharged brake fluid
- Adaptors included to fit most applications





### T71658 One Man Brake Bleeder

- Services caliper, brake and master cylinders
- Plastic bottle collects discharged fluid
- Powerful magnet attaches bottle to car
- Deluxe kit includes hoses and tapered fittings



### T71893 Universal Bearing Packer

- Evenly injects fresh grease while forcing out old grease
- Fits many rollers and ball bearings
- Works with most car, boat, trailer and RV bearings



### T71895 Portable Bearing Packer

- Simply press packer cap to inject new grease into bearing while forcing old grease out

Applicable: bearing max. I.D. 16mm and max. O.D. 95mm



### T71899 Disk Brake Pad Spreader

- Easily installs pads on most cars
- Compresses disc brake piston for fast installation



### T71900 Disc Brake Pad Spreader

- Easily installs pads on standard and four piston caliper disc brakes



### T71917 Brake Spring Washer Tool

- Removes and installs brake shoe retaining spring washers
- Use on both large and small washers



### T71921 Disc Brake Piston Remover

- Removes and installs disk brake pistons
- Rotates piston back into caliper cylinder
- Use on most imports, Ford, Chrysler and GM cars with four wheel disc brakes
- Use with 3/8" Dr. ratchet



### T75867 Brake Cylinder Retainer Remover

- Removes brake cylinder by expanding and holding retainer ring
- For GM "J" and "X" body cars







### T71640 Manual Brake Gauge Set



- Accurately measures brake lining
- Color coded gauge for easy identification
  - Red: 2, 3mm - Replace
  - Yellow: 4, 5, 6mm - Warning
  - Green: 8, 10, 12mm - Condition

### T75805 Rear Disc Brake Caliper Tool Set



This tool set is used to install new brake pads by winding the piston back into the caliper through the convenient T-bar rotation. Piston retraction is smoothly completed without damaging the piston or boot. Its 9 adaptors can be used on both 2 and 4 wheel disc brakes.

#### Applications:

Audi, BMW, Ford, GM, Honda, Mazda, Mercedes, Mitsubishi, Nissan, Rover, Subaru, Toyota, Volkswagen, and most 4WD vehicles

### T75879 21pc Rear Disc Brake Caliper Tool Set



- Includes more adaptors than T75805 for working on more and newer model vehicles
- Includes two T-bar center bolts with positive and negative thread for different models
- Consists of 19 adaptors and 2pc positive & negative thread center bolts

### T75808 Air Brake Service Set



#### Includes:

- Brake clevis pin press
- Manual slack adjuster puller
- Automatic slack adjuster puller

Designed to easily remove air brake push rod clevis pins and S-cam air brake manual and automatic slack adjusters in no time. Operates on class 7 and 8 tractor and trailer brake systems. Uses effective screw power to apply force directly upon the object to be removed. The manual slack adjuster puller fits all manual types while automatic slack adjuster puller fits automatic types of Rockwell, Haldex, Gunnite and Bendix air brake systems.



### T75816 Vacuum Pump / Brake Bleeding Set



Includes:

- Vacuum pump
- Die cast metal pump with fluid resistant valves
- Easy-to-read gauge (inches & millimeters)
- Brake bleeding kit

Everything you need to test cooling system temperature ranges, leaks and sensors. Pump's valves are resistant to most automotive fluids. Approximately pumps 1 cubic inch per stroke and holds about 25 inches of mercury vacuum. Gauge can be read easily by both right and left handed person.

### T75831 2-Way Vacuum Pump and Brake Bleeding Kit



Includes:

- 2-Way vacuum pump for both in and out flows
- Fluid resistant valve pump
- Easy-to-read gauge
- Brake bleeding kit
- Tests cooling system temperature ranges, leaks and sensors
- Pump's valve resists most automotive fluids
- Provides both in and out flows for versatile applications

### T75550 ABS Brake Pressure Test Kit



- Tests hydraulic pressure available to each wheel assembly
- Allows for balance testing to ensure pressure is being equally applied to front and rear wheels
- Kit consists of 22pc adaptors and reference table

### Flare Nut Wrenches



- Drop forged steel, chrome plated
- For tube fitting applications in automotive, refrigeration, and trucks
- Extra thick double-end design prevents damage to flare nuts and metal fittings

<b>T73383</b>	3pc Set (SAE)	<b>T73387</b>	3pc Set (Metric)
<b>T73384</b>	3/8" x 7/16"	<b>T73388</b>	10 x 12mm
<b>T73385</b>	1/2" x 9/16"	<b>T73389</b>	13 x 14mm
<b>T73386</b>	5/8" x 11/16"	<b>T73390</b>	15 x 17mm



### T73360 Double Flaring Tool Set - SAE



- Heavy duty construction withstands high pressure
- Use to double flare soft steel tubes and single flare soft brass, copper and aluminum
- Includes drop forged yoke and seven double flare adaptors
- SAE: 3/16", 1/4", 5/16", 3/8", 7/16", 1/2", 5/8"

### T73361 Metric: 1/4", 1/2", 4.75, 5, 6, 8, and 10mm

### T75756 Double Flaring Tool and Tube Cutter Set



This tool set is designed to accurately cut and double flare soft copper, aluminum and brass tubes of variable sizes. The die holding block is capable of being used with 3/16", 1/4", 5/16", 3/8", 7/16", 1/2", and 5/8" outer diameter tubes. Yoke type compressor features a convenient T-bar rotation that allows firm grip for powerful winding. Flaring cone pushes down on the die block for an effective compression to create a precise automotive 45-degree flare.

Tube cutter features two wide rollers for smooth cutting. An additional retractable locking reamer blade and cutter wheel are located under the reamer blade.

- Outside diameter capacity is 1/8" to 1-1/8".

### T75901 Flaring Tool Set



This tool set is designed to accurately flare and swage soft copper, aluminum and brass tubing of variable sizes. The die holding block is capable of being used with 1/8", 3/16", 1/4", 5/16", 3/8", 7/16", 1/2", 5/8" and 3/4" outer diameter tubes. Yoke type compressor features a convenient T-bar rotation that allows firm grip for powerful winding. Flaring cone pushes down on the die block for an effective compression to create a precise automotive 45-degree flare. The set's five spreaders enable the swaging of 3/16", 1/4", 5/16", 3/8", 1/2", 5/8", and 3/4" outer diameter tubes.

### T75877 9pc Disc Brake Service Tool Set



- Complete disc brake tools in convenient storage case
- Adjusts brake shoes, retaining rings and installs and removes brake caliper mounting bolts
- Contents:
  - T71578 Brake Adjustment Tool
  - T71610 Brake Spring Compressor
  - T71614 Brake Spring Pliers
  - T71900 Disc Brake Pad Separator
  - T71921 Disc Brake Piston Remover
  - T71682 3/8" Dr. T40 Disc Brake Caliper Star Socket
  - T71683 3/8" Dr. T45 Disc Brake Caliper Star Socket
  - T71684 3/8" Dr. T50 Disc Brake Caliper Star Socket
  - T75867 Brake Cylinder Retainer Remover



### T70557 Exhaust Spring Clamp Remover / Installer

- Essential for safe, controlled removal of clamps attaching exhaust to manifold
- Specially design provides leverage required to expand the strong spring clamps



### T72101 Steering Pivot Pin Remover

- Simplifies telescoping and tilting steering column services
- Suitable for GM, Chrysler and Ford vehicles produced with Saginaw steering columns



### T71522 Tailpipe and Tubing Cutter

- Quickly cuts exhaust and tailpipe in confined areas
- 16 cutting blades for fast and even cutting
- Cuts thin-wall copper and steel tubes of 3/4" to 3" in diameter



### T71525 Heavy Duty Adjustable Pipe Cutting Pliers

- Cuts exhausts, tailpipes, tubes, cans and filters
- Powerful leverage design with T-bar for progressive tightening adjustment when cutting



### T75822 Tailpipe Expanders



- Heavy duty steel construction
- Straightens out dents, bends in tailpipes and mufflers without damaging pipe or muffler
- 3 size capacities

**T75822** Small 1-1/8" to 1-3/4"

**T71519** Medium 1-1/2" to 2-7/16"

**T75820** Large 2-1/8" to 3-7/16"

### T72138 Seal Puller

- Easily removes oil and grease seals
- Heavy duty pro style handle
- 2 tip sizes reach most seal applications



### T72139 Seal Puller

- Heavy duty, heat-treated steel
- Easily removes grease and oil seals
- Red vinyl, non-slip handle
- 2 tips for multiple applications







### T72001 Front Wheel Drive Axle Nut Socket



- Chrome Molybdenum steel, 1/2" Dr.
- Extra long socket makes full contact with axle nut
- Prevents slippage and distortion of axle nuts

- T72005** 29mm Late model GM, Ford Escort, Fiesta
- T72001** 30mm for GM "X" and "A" style cars
- T72002** 32mm Late model FWD Honda & FWD Chrysler cars
- T72010** 33mm for GM and Chrysler
- T72003** 34mm Late model Buick, Cadillac, Chevy, Oldsmobile & Pontiac
- T72006** 35mm Late model GM
- T72004** 36mm for GM "E" style cars
- T72009** 38mm for Rover Allego, Metro, Mini 1100, 1300 flywheel nuts and ball joints
- T72011** 31mm for Honda

### T72044 1/2 Ton 4WD Bearing Locknut Tool



- Removes and installs 4 slot front axle lock nuts
- Reinforced outer lug sleeve for tough applications
- Heavy duty alloy steel
- Use for 1/2 ton 4WD vehicles

#### Applications:

- 1960 to current 1/2 Ton Chevrolet and GMC
- 1966 to current Bronco, Blazer, and Scout
- 1959 to current Ford F100 - 250
- 1969 to current Dodge international 1/2 Ton vehicles

### T72047 3/4 - 1 Ton 4WD Wheel Bearing Locknut Tool



- Removes and installs 6 slot front axle lock nuts
- Heavy duty alloy steel
- Use on 3/4 - 1 Ton Ford and GM cars and trucks

#### Applications:

- Dana 70 axles
- 1978 to current Ford 3/4 Ton vehicles
- 1973 to 1981 GM 3/4 Ton and 1 Ton vehicles

### T72048 1/2 - 3/4 Ton 4WD Wheel Bearing Locknut Tool



- Removes and installs 4 slot front axle lock nuts
- Heavy duty alloy steel
- Use on 1/2 - 3/4 Ton Ford and GM cars and trucks

#### Applications:

- 1986 to current Ford light trucks such as Bronco  
Bronco II and Ranger with Dana 44 axles
- 1960 to current 1/2 Ton Chevrolet and GMC
- 1966 to current Bronco, Blazer, and Scout
- 1959 to current Ford F100-250
- 1969 to current Dodge international 1/2 Ton vehicles



### T75868 1/2 - 1 Ton 4WD Wheel Bearing Locknut Tool



- Removes and installs large diameter 4 slot front axle lock nuts
- Use on 1/2 - 1 Ton Ford and GM cars and trucks
- Heavy duty alloy steel

#### Applications:

- |             |  |
|-------------|--|
| 1982 - 1990 | GM H.D. 3/4 and 1 Ton trucks   |
| 1985 - 1995 | Ford F-series 1/2 Ton truck and full size Bronco with Dana 28 front axle             |
| 1985 - 1995 | Ford F-series H.D. 3/4 and 1 Ton Dana 50 IFS or Dana 60 front axle equipped vehicles |

### Tubular Spanner Wrenches



Removes and installs rear wheel bearing locknuts

Extra heavy duty construction for high torque loading

- Chrome Vanadium steel
- "6 Lug Spanner" design
- Fits 3/4" Dr. ratchets

**T72049** 1946 to current Chevrolet and GMC 5200 & 7200 lb axles (Socket O.D. 2-5/8")

**T72050** 1954 to current Chevrolet and GMC 11000 & 13500 lb axles (Socket O.D. 2-7/8")

**T72051** 1954 to current Chevrolet and GMC 15000 lb axles  
1966 to current 17000 lb 2 speed axles  
1965 to current 15000 lb trailing axles (Socket O.D. 3-5/8")

### T72054 Ratcheting Lock Nut Tool



- Double-sided ratcheting style lock nut
- Small end fits Ford 1986 to 1994 light trucks with Dana 44 front axle
- Large end fits 1985 and newer Ford F150-F350 trucks with Dana 44 rear axle
- Use with 1/2" Dr. wrench

### T72040 Toyota Wheel Bearing Locknut Tool

- Removes and installs wheel bearing locknuts
- Heavy duty construction for loading high torque
- Use with 1/2" Dr. torque wrench
- Works on 1995 and newer Tacoma, 1996 and newer T100 and 4 Runner



### T72041 FWD Bearing Locknut Tool

- Heavy duty alloy steel
- Works on 1985 - late Ford F250 - 350 trucks rear axles with hi-shear rotating nut and DANA 80 rear axles for Ford trucks





### T72055 Water Pump Socket

- Unique design efficiently removes and installs water pump
- Heavy duty construction
- Fits 1993 to newer Cadillac Northstar 4.6 liter and 1997 to current Oldsmobile Aurora 4.0 liter
- Use with 1/2" Dr. wrench



### T75832 4WD Spindle Puller

- Pulls out 4WD front spindles for lubricating the inner needle bearing and front wheel alignment
- Fits common 4WD pickup spindles
- Sizes: 1-1/2", 1-5/8", and 2"



### T75301 Truck Wheel Bearing Lock Nut Sockets



<b>T75301</b>	6pt	2-3/32"	<b>T75310</b>	6pt	3-1/2"
<b>T75321</b>	6pt	2-1/2"	<b>T75311</b>	8pt	3-1/2"
<b>T75304</b>	6pt	2-9/16"	<b>T75325</b>	8pt	3-3/4"
<b>T75328</b>	6pt (R)	2-9/16"	<b>T75326</b>	6pt	3-3/4"
<b>T75322</b>	6pt	2-5/8"	<b>T75314</b>	6pt	4"
<b>T75323</b>	6pt	2-3/4"	<b>T75315</b>	6pt	4-1/8"
<b>T75334</b>	6pt	3-1/8"			

Essential for the easy removal and installation of truck wheel bearing lock nut. Each socket's hex opening shape fits exactly over the lock nut, maximizing the surface area for effective winding. Sockets have a 3/4" Dr. for attaching an extension rod to access hard-to-reach locknuts in confined areas. A ratchet can then be attached to the extension rod for additional torque.

### T75783 6pc Spindle Nut Wrench Set



- Chrome Vanadium steel construction for strength and durability
- Removes and installs 2/4 wheel drive light truck axle lock nuts
- Do not use with power tools

Contents and Applications:

<b>T72040</b>	Toyota 1995 and newer Tacoma, 1996 and newer T100 and 4 Runner
<b>T72041</b>	1985 to late Ford F250-350 trucks rear axle with hi-shear rotating nut and Ford Dana 80 truck rear axles
<b>T72044</b>	1960 to current 1/2 Ton Chevrolet and GMC, 1966 to current Bronco, Blazer and Scout, 1959 to current Ford F100-250 series, 1969 to current Dodge 1/2 Ton vehicles
<b>T72047</b>	1978 to current Ford 3/4 Ton vehicles, 1973 to 1981 GM 3/4 Ton and 1 Ton vehicles
<b>T72048</b>	1986 to current Ford Bronco and Ranger with Dana 44 axles, 1960 to current 1/2 Ton Chevrolet and GMC, 1966 to current Bronco, Blazer and Scout, 1959 to current Ford F100-250 series, 1969 to current Dodge 1/2 Ton vehicles
<b>T75832</b>	Works on common 1/2 and 3/4 Ton 4-wheel drive pickup spindles



### T75773 7pc Wheel Bearing Lock Nut Socket Set



Great for easy removal and installation of passenger car wheel bearing lock nuts. Each socket's hex opening fits exactly over the lock nut, maximizing the surface area for effective winding. The sockets have a 1/2" Dr. that can have an extension rod attached to access hard-to-reach lock nuts in confined areas. A ratchet can then be attached to the extension bar for additional torque.

Contents and Applications:

- T75350** 6pt 2-3/8" 1984 -1992 Ford Ranger & Bronco
- T75351** Round 6pt 2-3/8" 1990 to current Ford Ranger & Bronco
- T75352** 6pt 2-1/2" Light duty trucks with rear axle and front axle
- T75353** Round 6pt 2-1/2" 1995 - 1996 F150 trucks and Bronco
- T75354** Round 6pt 2-9/16" 1990 - 1993 Dodge trucks with Dana 60 manual hubs
- T75355** 2-3/4" Round 6pt 3/4 and 1 Ton F250 and F350 trucks with automatic locking hubs
- T75356** 6pt 55mm Toyota front wheel adjusting nuts

### T75746 9pc 1/2" Dr. Twister Socket Set (Metric)



- Chrome Molybdenum steel
- Designed to safely and easily remove damaged or rounded head fasteners
- No pounding chisels, hammers or torches
- Includes 8mm straight rod to remove fasteners from sockets
- Size: 10, 11, 12, 13, 14, 15, 16, 17, 19mm

### T75770 Adjustable Wheel Bearing Lock Nut Wrench Set



- Capacity:
  - 6pt Lock Nuts: 1-3/4" to 5-1/4"
  - 8pt Lock nuts: 1-3/4" to 5-5/8"
  - Pin diameters: 1/4", 5/16", and 3/8"
- Adjustable jaws with locking feature fits both hexagon and octagon wheel bearing lock nuts
- Includes 3 pin sets to work with pin holes

### T75795 5pc 1/2" Dr. Thin Wall Impact Socket Set



- Chrome Molybdenum steel for strength and durability
- Protective sleeves and plastic insert design prevents wheels and lug nuts from scratching
- Thin wall and deep hollow design fits most high performance alloy wheels
- Sizes: 3/4", 13/16", 7/8", 1", and 1-1/16"





### T75793 3pc 1/2" Dr. Thin Wall Impact Socket Set



- Chrome Molybdenum steel for strength and durability
- Protective sleeves and plastic insert design prevents wheels and lug nuts from scratching
- Thin wall and deep hollow structure fits most high performance alloy wheels
- Sizes: 17, 19, and 21mm

### T75774 9pc 1/2" Dr. Axle Nut Socket Set



- Chrome Molybdenum steel for performance and durability
- Extra long sockets prevent distortion and slippage on most domestic and import vehicles

Contents: 29, 30, 31, 32, 33, 34, 35, 36, 38mm

Applications:

- T72005** 29mm late model GM, Ford Escort, Fiesta
- T72001** 30mm for Ford GM "X" and "A" style cars
- T72002** 32mm Late model FWD Honda & FWD Chrysler cars
- T72003** 34mm Late model Buick, Cadillac, Chevy, Oldsmobile & Pontiac
- T72006** 35mm Late model GM
- T72004** 36mm for GM "E" style cars
- T72011** 31mm for Honda
- T72010** 33mm for GM and Chrysler
- T72009** 38mm for Rover Allego, Metro, Mini 1100, 1300 flywheel nuts and ball joints



### T75799 Flip Impact Socket Set

- Chrome Molybdenum steel for strength and durability
- Contents:  
1/2" Dr. flip impact sockets: 3/4" x 13/16",  
19mm x 21mm and 1/2" Dr. x 3" extension bar



### T70070 Tie Rod Adjusting Tool

- Versatile design enables 360 degree rotation of adjusting sleeve in confined areas
- Use on light trucks with 1-1/8" diameter adjusting sleeves
- Use with 1/2" Dr. ratchet or breaker bar



### T72059 Tie Rod Separator



### T72059 Tie Rod Separator

- Drop forged steel
- Rod separator removes tie rod from connecting links
- Opening: 21/32"

### T72060 Ball Joint Separator

- Removes ball joints from connecting links
- Opening: 15/16"

### T72061 Universal Ball Joint Puller (For Trucks)

- Powerful leveraged screw action removes ball joints efficiently without damaging axle or wheel housing
- Easy assembly and disassembly for convenient, compact storage
- Fits all truck ball joint sizes



### T72062 Universal Ball Joint Puller (For Cars)

- Powerful leveraged screw action removes ball joints efficiently without damaging axle or wheel housing
- Easy assembly and disassembly for convenient, compact storage
- Fits all domestic and imported car ball joint sizes



### T72058 Universal Ball Joint Remover

- Splits track rod ends, anti-roll bar mountings and ball joints in confined areas
- Fully adjustable for different size ball joints
- Jaw opening: 20mm



### T72066 Ball Joint Separator

- Designed for speedy removal of ball joints on steering and suspension systems
- Durable drop-forged, heat-treated steel assembly for heavy duty applications
- Jaw opening: 19mm
- Maximum opening capacity: 38mm





### T72067 Universal Ball Joint Separator

- Heavy duty "Scissor" design fits most cars and light trucks
- Easily separates press fit ball joints
- Durable, drop forged steel
- Quick-change steel pin and heat-treated thrust bolt with steel ball inserted into tip for heavy duty applications



### T72068 Universal Ball Joint Separator

- Heavy duty "Scissor" design ideal for most vehicles
- Durable, drop forged steel
- 2 Stage operation and offset lever easily separates press fit ball joints
- Quick-change steel securing pin allows for easy services on most passenger vehicles and light trucks



### T72069 Pitman Arm Puller

- Heavy duty, heat-treated, drop forged steel
- Removes pitman arms from most cars
- Opening: 1-5/16"; Pull: 2-1/2"



### T72070 Tie Rod End / Pitman Arm Puller

- Heavy duty, heat-treated, drop forged steel
- Removes pitman arms from most compact cars and light trucks
- Opening: 1-1/16"; Pull: 1-3/4"



### T72074 Universal Pitman Arm Puller

- Heavy duty, drop forged, heat-treated jaws
- Bolt lock clamp jaws ensure firm grip
- Fits most vehicles and light trucks
- Max. opening 2-1/2"; Throat depth 3-3/8"



### T72090 Inner Tie Rod Crimper Tool

- Crimps tie rod housing to rack flats to prevent tie rod from coming loose
- Works with all GM and Chrysler vehicles using Saginaw steering gear



### T72092 Ball Joint / Tie Rod End Remover

- Fits most front wheel drive vehicles and light trucks
- Adaptor directly attaches to stud for easy and convenient use



### T72064 Ball Joint Extractor

- Splits track rod ends, anti-roll bar mountings and ball joints in confined areas
- Fully adjustable for different size ball joints
- Jaw opening: 18mm





### T72093 Ball Joint Puller

- Splits track rod ends, anti-roll bar mountings and ball joints in confined areas
- Fully adjustable for different size ball joints
- Jaw opening: 23mm, Jaw depth: 25mm



### T72094 Universal Tie Rod End Tool

- Fits most cars and 4WD vehicles
- To use, insert tool between spindle arm and tie rod



### T72098 Universal Tie Rod Tool

- Double-end enables 360 degree winding in confined areas
- Fits and adjusts tie rods on most cars and light trucks with split tie rod sleeves



### T72104 "S" Type Drainer Wrench

- Sizes: square 8 & 10mm
- Drop forged steel
- Ideal for working on back axles, gearboxes and draining jobs



### T72124 Lug Nut Cap Remover



- Specially designed to grip and twist heavy duty lug nuts without damaging the cap or marring the chrome finish
- Cushioned handle for added comfort

### T75777 Drive Shaft Boot Changer



This device easily changes the drive shaft boot in no time.

12 different sized thread adaptors fit popular Japanese vehicles.

Applications:

M18 x P1.5 - Suzuki, M19 x P1.5 - Toyota

M20 x P1.0 - Nissan, Daihatsu,

M20 x P1.5 - Nissan, Mazda

M20 x P1.75 - M22 x P1.0 - Nissan

M22 x P1.5 - Nissan, Honda, Mitsubishi, Isuzu, Daihatsu, Mazda, Subaru

M24 x P1.5 - Nissan, Honda, M26 x P1.5 - Honda

M30 x P1.5 - 5/8" x 18 - Mini, 7/8" x 14 - Mini





### T75517 Outer Tie Rod Remover



This handy tool removes the outer tie rod from steering knuckle. The adjustable jaw spread can match tie rods of variable sizes. The custom designed jaw tips ensure a firm grip that will withstand up to five tons of force. By utilizing balanced mechanical screw power to evenly distribute pulling force, leaving no trace of damage on existing components. This tool can be used on foreign and domestic cars with front / rear wheel drives and stamped / cast steel steering knuckles.

### T75802 1-7/16" Inner Tie Rod Adaptor



- Removes and installs inner tie rod without the need to remove steering gear
- Use with T72088 Inner Tie Rod Tool
- For GM and Chrysler cars with Saginaw steering gear

### T75804 Inner Tie Rod Tool



- Removes and installs inner tie rod without removing rack from car
- Black oxide finish to resist corrosion
- Double-end socket fits: 1-3/16" hex - some Ford (FWD) and Renault; 1-15/16" hex - GM, American Motors, Chrysler and Ford (RWD)

### T75823 Inner Tie Rod Removal Set



Includes:

- Inner Tie Rod Socket Tool (T75804)
- Double Inner - Hex: 1-3/16" and 1-5/16"
- 1/2" Square Drive
- 3 Adaptors: 1-3/16", 1-5/16", 1-7/16"

No need to waste anymore time taking off the steering gear when your automobile's inner tie rods need replacing. This tool kit contains everything you need to directly remove and install the inner tie rod without the hassle of removing the steering gear. This can be used with both modern and old fashioned inner tie rod structures. The socket tool, double inner hex matches many vehicles, primarily Ford, Renault, GM, and Chrysler. The 1-3/16" hex applies to Ford (FWD) and Renault. The 1-5/16" hex applies to GM, American Motors, Chrysler, and Ford (RWD) vehicles. It also has a 1/2" square drive for torque wrench attachments. The 3 adaptors, used with the socket tool, operate on Ford, GM, and Chrysler vehicles. The 1-3/16" and 1-5/16" adaptors apply to vehicles with rack and pinion power steering and modern inner tie rods. The 1-7/16" adaptor applies to vehicles with Saginaw steering gear.



### T75801 3-in-1 Ball Joint Service Set



3 Functions:

- Ball joint servicing
- Universal joint servicing
- Truck brake anchor pin service

This tool set contains three functions: removal / installation of ball joints, universal joints and truck brake anchor pins. Ball joint service can be implemented without having to take off the control arm. Universal joint service can be utilized on U-joints with needle-type bearings. Truck brake anchor service can be used with pins up to 1-1/4" in diameter. This set works with press-fit automotive components.

### T75806 4-in-1 Ball Joint Service Set



4 Functions:

- Ball joint service
- Universal joint service
- Truck brake anchor pin service
- 4 Wheel drive ball joint service

This tool set has four functions: removal / installation of ball joints, universal joints, truck brake anchor pins and 4WD ball joints. Both ball joint service and 4WD ball joint service can be implemented without having to take off the control arm. Universal joint service can be utilized on U-joints with needle type bearings. Truck anchor pin service can be used with pins up to 1-1/4" in diameter. 4WD ball joint service equipment broadens the application to include vehicles with Dana 44 front axles such as 1967 to current 1/2 Ton and 3/4 Ton GM, Ford, Dodge, IHC and Jeep 4WD vehicles. For press-fit automotive components.

### T75812 Master Ball Joint Adaptor Set



Includes:

- T75809
- T75810
- T75811
- T75819

Broadens the 3-in-1 Ball Joint Service Set (T75801) applications dramatically to work with a wide variety of vehicles. The set comprises installing and removing adaptors, receiver tubes and one center bolt. Operates with press-on type ball joints.

Applications:

Most GM, Dodge Ram, Jeep vehicles and 2WD Ford vans  
1967 to current 1/2 Ton and 3/4 Ton Dodge, GM, Ford, IHC,  
Jeep vehicles (autos with Dana 44 front axles)



### T75809 4WD GM Ball Joint Adaptor Set



Removes and installs press-on type lower ball joints. Expands the 3-in-1 Ball Joint Service Set (T75801), making it compatible with most GM vehicles. Set contains 3 adaptors.

Applications:

GM - 1996, late 4WD 1/2, 3/4 Ton pickups, Suburbans and Yukon / Tahoe vehicles

### T75810 Dodge Ram / Jeep Ball Joint Adaptor Set



Removes and installs upper and lower ball joints, and offset ball joints used to change caster / camber. Extends the 3-in-1 Ball Joint Service Set (T75801), making it compatible with almost all Dodge Ram and Jeep vehicles. Set includes 4 adaptors.

Applications:

1987 to current Jeep Wrangler  
1990 to current Jeep Renegade  
1993 to current Jeep Grand Cherokee  
1994 to current Dodge Ram 4WD 1/2 Ton pickup

### T75811 2WD Ford Van Ball Joint Adaptor Set



Removes and installs press-on type upper and lower ball joints. This tool set broadens the 3-in-1 Ball Joint Service Set (T75801), making it compatible with most 2WD Ford vans. Set consists of 6 adaptors.

Applications:

1992 - 1997 Ford 2WD 3/4 and 1 Ton vans

### T75819 4WD Ball Joint Adaptor Set



Removes and installs upper and lower ball joints. Extends the application of the 3-in-1 Ball Joint Service Set (Model # T75801). Set includes 3 adaptors.

Applications:

1967 - current 1/2 and 3/4 Ton 4WD vehicles with Dana 44 front axle on GM, Ford, Dodge, IHC and Jeep



### T75869 Pickle Fork Kit



Includes:

- 11/16" Wedge opening tie rod separator
- 15/16" Jaw opening ball joint separator
- 1-1/8" Opening pitman arm wedge
- 8" Handle to use with regular hammer
- 401 Shank handle to use with air hammer

Quickly separates ball joints, tie rods, pitman arms and shock absorber links. This kit contains cast-iron forks and 2 alloy steel handles that work with either regular or impact hammers. All 3 forks are interchangeable with either handle. Pilot head design handles absorb shock and protect threads from distortion.

### T75602 Seal Driver Set



Makes the job of driving seals into their axle housing quick and easy. Contains 16 high-impact adaptors designed to fit most seal sizes up to 3-3/8" in diameter. Three of the adaptors are recessed to fit shielded seals.

### T75903 Bearing Race / Seal Driver Set



Inserts the wheel bearing race and seal without damaging the bearing race or axle housing. Features double-sided discs to drive seals or bearing races. Includes 9 disc sizes to fit bearing races and seals on most domestic and import vehicles. Also includes a hose plug and cap kit

### T72158 Wheel Stud Alignment Guide Tool - M14

- Guides wheel stud alignment when mounting wheels with long lug bolts
- Size: M14 x 1.5
- Works on all Mercedes models with lug bolts



### T72159 Wheel Stud Alignment Guide tool - M12

- Guides wheel stud alignment when mounting wheels with long lug bolts
- Size: M12 x 1.5
- Works on all Mercedes models with lug bolts







### T72160 "T" Handle Disclosed Tire Repair Tool

- Repairs punctured tires by plugging puncture with rubber coated inserts
- Designed for steel belted radial tires



### T72167 4-in-1 Valve Stem Repair Tool

- Removes and installs tire core valves
- Rethreads the inside and outside of the valve stem
- Features E-Z Out for removing broken valve parts when shoulders are broken



### T72169 Wheel Cover Tool

- Removes and installs wheel covers and hub caps
- Durable handle, rubber head and tip are designed for quick wheel cover replacement



### T72175 Wheel Weight Tool

- Removes and installs wheel weights
- Heavy duty construction
- Balanced to swing as a hammer



### T72207 Dial Type Gauge

- Zinc alloy case, enamel finish
- Chrome plated valve head and acrylic dial scales
- 10 - 60psi & 0 - 4.5kg/cm<sup>2</sup>



### T72231 Offset Tire Gauge

- Calibrated 10 - 120 psi and 19kg/cm<sup>2</sup>
- Chrome plated, pocket clip



### T72164 Valve Core Torque Tool

- Maintain proper pressure to prevent over or under torque
- Prevent premature tire failure due to valve leakage
- Also use as tire core remover and installer
- Torque range: 45N. Cm /4 Lb. in (± 6%)



### T72165 Valve Core Torque Tool

- Maintain proper pressure to prevent over or under torque
- Prevent premature tire failure due to valve leakage
- Also use as tire core remover and installer
- Torque range: 25N. Cm /2 Lb. in (± 6%)





### T73147 5pc Screw Extractor Set

- Removes broken studs, screws, bolts, pipes and fittings
- Chrome Molybdenum steel
- Features flutes for more positive grip
- Sizes: 1/8", 3/16", 15/64", 5/16" and 3/8"



### T73148 5pc Screw Extractor Set

- Removes broken studs, screws, bolts, pipes and fittings
- Chrome Molybdenum steel
- Sizes: 1/8", 3/16", 15/64", 5/16" and 3/8"



### T73151 5pc Screw Extractor Set

- Removes broken studs, screws, bolts, pipes and fittings
- Chrome Molybdenum steel
- Sizes: 5/64", 7/64", 5/32", 1/4" and 19/64"



### T73153 6pc Screw Extractor Set

- 6 heavy duty steel extractors, reverse threaded for easy broken screws, bolts, studs or pipes removal
- Sizes: 1/8", 1/4", 5/16", 7/16", 9/16", 3/4"



### T75927 4pc Stud Puller Set - SAE



- Removes threaded studs without damaging threads
- Alloy steel, heat-treated
- Use with ratchet or breaker bar
- Sizes: 3/8" Dr.: 1/4", 5/16"  
1/2" Dr.: 3/8", 7/16"

### T75928 4pc Stud Puller Set - Metric

- Sizes: 3/8" Dr.: 6, 8mm,  
1/2" Dr.: 10, 12mm

### T70616 Clip Remover

- Removes clips in hard-to-reach or confined areas
- Dual-head design allows proper leverage for easy access and faster pull



### T72135 Automatic Center Punch

- Automatic design cleanly and accurately punches steel, wood and plastic
- Heavy duty brass construction





### T73302 Flat Clamp Pliers

- Removes and installs flat band hose clamps
- Rotating jaws can grip at any angle
- Ratchet lock lever holds jaws closed at different angles
- Heavy duty, durable construction



### T73303 Angled Flat Band Hose Clamp Pliers

- Removes and installs flat band clamps where access is limited
- Long, angled jaws with rotating grooved tips grip at any angle
- Fine tooth ratcheting lock lever frees both hands for hose positioning



### T75630 Internal / External Snap Ring Pliers Set



- 11pc combination of internal, external, straight, and bend snap ring pliers
- Chrome Molybdenum steel for strength and durability
- Insulated vinyl handle for positive grip
- 5" hook and pick tools included

### T75632 10pc - 1/2" Heavy Duty Replaceable Tip Circlip Pliers Set



- Includes:
  - 8 - Replaceable Internal / External Tips (0.108" & 0.12")
  - 1 - Internal Circlip Pliers
  - 1 - External Circlip Pliers
- Replaceable tips with spring ratchet lock mechanism securely holds circlip against tension
- Offset tips for internal and external circlips
- Tips must be toed inward for internal applications and outward for external applications



### T75740 10pc 1/2" Dr. Torque Extension Bar Set



- Eliminates over torqued lug nuts, broken or damaged stud nuts
- Prevents distortion of rotors, drums and wheels
- Easily torques wheel nuts to the correct torque
- Chrome Vanadium steel construction for exceptional accuracy and durability
- Color coded for easy size identification
- Sizes:
  - 55 Ft.Lb, 75Nm, 17mm Green
  - 65 Ft.Lb, 90Nm, 3/4" (19mm) Yellow
  - 80 Ft.Lb, 110Nm, 17mm Red
  - 80 Ft.Lb, 110Nm, 3/4" (19mm) Blue
  - 80 Ft.Lb, 110Nm, 21mm Light Brown
  - 100 Ft.Lb, 135Nm, 13/16" Brown
  - 100 Ft.Lb, 135Nm, 3/4" (19mm) Gray
  - 120 Ft.Lb, 160Nm, 7/8" (22mm) White
  - 140 Ft.Lb, 190Nm, 7/8" (22mm) Turquoise
  - 140 Ft.Lb, 190Nm, 15/16" Light Blue

### T75742 4pc 1/2" Dr. Torque Extension Bar Set (Metric)



- Contents:
  - 90Nm (65Ft.Lb)
  - 110Nm (80Ft.Lb)
  - 135Nm (100Ft.Lb)
  - 160Nm (120Ft.Lb)

### T75840 6pc Industrial Punch and Chisel Set



- Special go-thru handle design for impact use
- Chrome Molybdenum steel
- Black phosphate finish to resist corrosion
- Sizes:
  - 1 - Prick Punch,
  - 1 - Center Punch,
  - 4 - Chisels (10mm, 30mm, 50mm, 78mm)





### T75842 9pc Brass Punch and Hammer Set



- Solid brass construction and wood handle prevent sparks when struck upon in electric and ignition areas
- Includes:
  - 2 - Hammers: 1/2 lb and 1 lb
  - 2 - Pin Punches: 1/2" - 1/4" x 4", 1/2" - 3/8" x 6"
  - 2 - Tapered Punches: 7/16" x 14", 3/8" x 8"
  - 1 - Hex Tapered Punch: 3/8" x 8"
  - 1 - Drift Punch: 1/2" x 8"
  - 1 - Bar Punch: 3/4" x 10"

### T70056 9pc Gasket & Hollow Punch Set

- Driving mandrel and 9 punches: 2.5, 3, 4, 5, 6, 7, 8, 9, 10mm
- Not for cutting metal



### T73402 Power Scissors

- Stainless steel, offset blades for safety
- Great for use in offices, gardens, garages, and workshops



### Putty Knives / Wall Scrapers



#### Putty Knives:

- Semi-flexible tempered blades for putties and glues

#### Wall Scrapers:

- Extra-rigid stainless steel blades for tough scraping jobs

Putty Knives		Wall Scrapers	
T70785	1-1/4"	T70789	1-1/4"
T70786	2"	T70790	2"
T70787	3"	T70791	3"
T70788	4"	T70792	4"

### T73158 6pc Electrical Screwdriver Set

- Heat-treated alloy steel, black oxide tips
- Color-coded caps for easy identification
- Slotted: 2.4 x 75mm, 3.0 x 100mm, 3.8 x 150mm
- Phillips: #0 x 75mm, #1 x 100mm, #2 x 150mm



### T74610 Deluxe Siphon Pump

- Multi-use for liquid or gases transfers
- Facilitates easy and fast transfer



**T73472 27pc Character Stamp Set**

- Heavy duty steel construction to prevent bending or chipping under repeated blows

<b>T73472</b>	1/8" (3mm)
<b>T73473</b>	5/32" (4mm)
<b>T73474</b>	3/16" (5mm)
<b>T73475</b>	1/4" (6mm)
<b>T73476</b>	5/16" (8mm)

**T73479 9pc Numerical Stamp Set**

- High quality, heavy duty steel prevents any bending or chipping under the toughest jobs

<b>T73479</b>	1/8" (3mm)
<b>T73480</b>	5/32" (4mm)
<b>T73481</b>	3/16" (5mm)
<b>T73482</b>	1/4" (6mm)
<b>T73484</b>	5/16" (8mm)

**T73404 4" (100mm) Magnetic Tray - Round**

- Keeps loose nuts, bolts, screws and metal pieces in place
- Stainless steel, strongly magnetized

**T73405 6" (150mm) Magnetic Tray - Round**

**T73406 Magnetic Tray - Rectangle**

- Stainless steel, fully magnetized
- Heavy duty rubber covered magnets
- Keeps loose nuts, bolts, screws and metal pieces in place
- Size: 9-1/2" (L) x 5-1/2" (W)

**T73410 9pc Magnetic Tray w/ Extendable Flashlight Magnetic Tools Holder w/ Pick Set**

- Contents:
  - 1 - Heavy Duty Telescoping Pickup and 3-LED Flashlight
  - 1 - Pocket Magnetic Pickup
  - 4 - Two-Tone Color Grip Handle Pick Set
    - 1 - Curved Hook
    - 1 - 45-Degree Hook
    - 1 - 90-Degree Hook
    - 1 - Straight Pick
  - 1 - Magnetic Tray-Rectangle
  - 2 - 18" Magnetic Tool Holder



**A5616**
**21pc 1/2" Dr. Impact Socket Set (Metric)**
**Contents:**

- 9 - 1/2" Dr. Impact Sockets:  
13, 15, 16, 17, 18, 19, 21, 22, 24mm
- 9 - 1/2" Dr. Deep Impact Sockets:  
13, 15, 16, 17, 18, 19, 21, 22, 24mm
- 1 - 1/2" Dr. x 5" Extension Bar
- 1 - 1/2" Dr. Universal Joint
- 1 - 1/2" Dr. (F) x 3/4" (M) Air Impact Adaptor

**A5617**
**21pc 1/2" Dr. Impact Socket Set**
**Contents:**

- 9 - 1/2" Dr. Impact Sockets:  
13, 15, 16, 17, 18, 19, 21, 22, 24mm
- 9 - 1/2" Dr. Deep Impact Sockets:  
13, 15, 16, 17, 18, 19, 21, 22, 24mm
- 1 - 1/2" Dr. x 5" Extension Bar
- 1 - 1/2" Dr. Universal Joint
- 1 - 1/2" Dr. (F) x 3/4" (M) Air Impact Adaptor

**T15810**
**121pc Crimping Tool Set**
**Contents:**

- 1 - 9-1/2" 5-Way Crimping Tool
- 120 - Insulate Connectors/Terminals:
  - 20 - Insulate Spade Terminal
  - 20 - Insulate Ring Terminal
  - 20 - Insulate Butt Connectors
  - 20 - Insulate Butt Connectors
  - 20 - Insulate Male Disconnectors
  - 20 - Insulate Femal Disconnectors

**T18400**
**4pc 8" Pro Style File Set**
**Contents:**

- 1 - Round File
- 1 - Mill File
- 1 - Three-Square File
- 1 - Half-Round File

**T18407**
**9pc Engineers Files & External Thread Restorer File Set**
**Contents:**

- 1 - 8" Mill File
- 1 - 8" Round File
- 1 - 8" Half-Round File
- 1 - Feeler Gauge
- 5 - External Thread Restorer File Set

**T18408**
**9pc 8" Professional File Set**
**Contents:**

- 6 - Needle Files (3mm x 100mm):  
Round, Half-Round, Flat, Square, Equaling, Triangle
- 3 - 8" (200mm) Pro Style Files:  
Round, Half-Round, Triangle

**T20680**
**7pc Hammer, Chisel & Punch Set**
**Contents:**

- 1 - Engineer's Hammer
- 1 - Soft Hammer (16oz.)
- 1 - Cold Chisel: 18mm x 165mm
- 3 - Pin Punches: 4 x 150, 5 x 165, 6mm x 180mm
- 1 - Center Punch: #2 x 120mm

**T20684**
**4pc Hammer, Chisel & Punch Set**
**Contents:**

- 1 - 10" Flat Cold Chisel
- 1 - 10" Center Punch
- 1 - 2-in-1 Quick-Change Hammer (20oz.)
- 1 - Engineer's Hammer (16oz.)

**T22903**
**7pc T-Handle Tamper-Proof Star & Star Wrench Set**
**Contents:**

- T10, T15, T20, T25, T27, T30, T40

**T22904**
**7pc T-Handle Ball Point & Hex Wrench Set (Metric)**
**Contents:**

- 2.5, 3, 4, 5, 6, 7, 8mm

**T22905**
**7pc T-Handle Tamper-Proof Star & Star Wrench Set**
**Contents:**

- T10, T15, T20, T25, T27, T30, T40

**T22906**
**7pc T-Handle Ball Point & Hex Wrench Set (Metric)**
**Contents:**

- 2.5, 3, 4, 5, 6, 7, 8mm

**T22937**
**42pc Hex & Star Wrench Set (Metric & SAE)**
**Contents:**

- 7 - Folding Hex Wrench Set  
1.5, 2, 2.5, 3, 4, 5, 6mm
- 8 - Folding Tamper-Proof Star Wrench Set  
T8, T10, T15, T20, T25, T27, T30, T40
- 9 - "L" Type Star Wrenches:  
T10, T15, T20, T25, T27, T30, T40, T45, T50
- 9 - "L" Type Long Ball Point Hex Wrenches (SAE):  
1/16", 5/64", 3/32", 1/8", 5/32", 3/16", 1/4", 5/16", 3/8"
- 9 - "L" Type Long Hex Wrenches (Metric):  
1.5, 2, 2.5, 3, 4, 5, 6, 8, 10mm

**T22938**
**27pc Hex & Star Wrench Set (SAE & Metric)**
**Contents:**

- 9 - "L" Type Star Wrenches:  
T10, T15, T20, T25, T27, T30, T40, T45, T50
- 9 - "L" Type Long Ball Point Hex Wrenches (Metric):  
1.5, 2, 2.5, 3, 4, 5, 6, 8, 10mm
- 9 - "L" Type Long Ball Point Hex Wrenches (SAE):  
1/16", 5/64", 3/32", 1/8", 5/32", 3/16", 1/4", 5/16", 3/8"

**T22939**
**27pc Hex & Star Wrench Set (Metric)**
**Contents:**

- 9 - "L" Type Star Wrenches :  
T10, T15, T20, T25, T27, T30, T40, T45, T50
- 9 - "L" Type Hex Wrenches:  
1.5, 2, 2.5, 3, 4, 5, 6, 8, 10mm
- 9 - "L" Type Long Ball Point Hex Wrenches:  
1.5, 2, 2.5, 3, 4, 5, 6, 8, 10mm

**T23230**
**8pc Knife & Tape Set**
**Contents:**

- 1 - Heavy Duty Snap-off Knife (18mm)
- 1 - Utility Knife
- 5 - Heavy Duty Utility Blades
- 1 - Tape Measure: 5m x 19mm

**T23346**
**18pc Multi-Use Tool Set**
**(Saw / Screwdriver / Knives / Tape Measures)**

Contents:

- 9 - Quick-Clamp Recip Saw & Bit Driver
  - 1 - Metal Saw
  - 1 - Wood Saw
  - 1 - Bit Driver
- 6 - 1/4" Screwdriver Bits (25mm):
  - 2 - Slotted: 3/16", 1/4"
  - 2 - Phillips: #1, #2
  - 2 - Star: T15, T20
- 2 - Auto-Lock Tape Measure (Stainless Steel Case) :
  - 3m x 16mm, 5m x 19mm
- 1 - Auto Lock Snap-Off Knife
- 1 - Utility Knife
- 5 - Utility Knife Replacement Blades

**T23347**

**18pc Multi-Use Tool Set  
(Saw / Screwdriver / Knives / Tape Measures)**

Contents:

- 9 - Quick-Clamp Recip Saw & Bit Driver
  - 1 - Metal Saw
  - 1 - Wood Saw
  - 1 - Bit Driver
- 6 - 1/4" Screwdriver Bits:
  - 2 - Slotted: 3/16", 1/4"
  - 2 - Phillips: #1, #2
  - 2 - Star: T15, T20
- 2 - Auto-Lock Tape Measure (Stainless Steel Case) :
  - 3m x 16mm, 5m x 19mm
- 1 - Auto Lock Snap-Off Knife
- 1 - Utility Knife
- 5 - Utility Knife Replacement Blades

**T25608**

**4pc Scrapers & Hammer Set**

Contents:

- 1 - 1-1/4" Go-Thru Scraper - Straight
- 1 - 1-1/4" Go-Thru Scraper - Angled
- 1 - 3" Go-Thru Scraper - Angled
- 1 - Ball Pein Hammer: 12oz.

**T28390**

**5pc Professional Pliers Set**

Contents:

- 1 - 6" Diagonal Cutting Pliers
- 1 - 6" Slip Joint Pliers
- 1 - 7" Combination Pliers
- 1 - 6" Long Nose Pliers
- 1 - 10" Groove Joint Pliers

**T28391**

**3pc Professional Pliers Set**

Contents:

- 1 - 6" (150mm) Long Nose Pliers
- 1 - 6" (150mm) Diagonal Cutting Pliers
- 1 - 6" (150mm) Slip Joint Pliers

**T28392**

**3pc High Leverage Pliers Set**

Contents:

- 1 - 7" (180mm) Heavy Duty Cutting Pliers
- 1 - 7" (180mm) Combination Pliers
- 1 - 8" (180mm) Long Nose Pliers

**T28396**

**2pc Professional Pliers Set**

Contents:

- 1 - 8-1/2" (215mm) High Leverage Combination Pliers
- 1 - 9-1/2" (240mm) Water Pump Pliers

**T28397**

**2pc Professional Pliers Set**

Contents:

- 1 - 10" (250mm) Locking Pliers
- 1 - 10" (250mm) Adjustable Wrench

**T28593**

**5pc High Leverage Pliers Set**

Contents:

- 1 - 5" (125mm) High Leverage Mini Long Nose Pliers
- 1 - 5" (125mm) High Leverage Mini Diagonal Cutting Pliers
- 1 - 7-1/2" (190mm) High Leverage Long Nose Pliers
- 1 - 7-1/2" (190mm) High Leverage Diagonal Cutting Pliers
- 1 - 7-1/2" (190mm) High Leverage Combination Pliers

**T28946**

**3pc Pliers and Wrench Set**

Contents:

- 1 - 8" (200mm) Adjustable & Pipe Stubby Wrench
- 1 - 10" (250mm) Lock Grip Pliers
- 1 - 9-1/2" (240mm) Water Pump Pliers

**T28949**

**4pc Snap Ring Pliers Set**

Contents:

- 1 - 7" (180mm) Straight Nose Pliers
- 1 - 7" (180mm) Bent Nose Internal Pliers
- 1 - 7" (180mm) Straight Nose External Pliers
- 1 - 7" (180mm) Bent Nose External Pliers

**T28950**

**3pc Pliers Set**

Contents:

- 1 - 6" (150mm) Diagonal Cutting Pliers
- 1 - 6" (150mm) Combination Pliers
- 1 - 9-1/2" (240mm) Water Pump Pliers

**T28951**

**3pc Pliers and Wrench Set**

Contents:

- 1 - 8" (200mm) Adjustable Wrench
- 1 - 10" (250mm) Lock Grip Pliers
- 1 - 9-1/2" (240mm) Water Pump Pliers

**T28952**

**3pc Pliers Set**

Contents:

- 1 - 8" (200mm) Long Nose Pliers
- 1 - 7" (180mm) Combination Pliers
- 1 - 7" (180mm) Heavy Duty Cutter

**T28953**

**4pc Snap Ring Pliers Set**

Contents:

- 1 - 7" (180mm) Straight Nose Internal Pliers
- 1 - 7" (180mm) Bent Nose Internal Pliers
- 1 - 7" (180mm) Straight Nose External Pliers
- 1 - 7" (180mm) Bent Nose External Pliers

**T28954**

**3pc Insulated Pliers Set (VDE 1000V)**

Contents:

- 1 - 8" (200mm) Long Nose Pliers / VDE
- 1 - 7" (180mm) Heavy Duty Diagonal Cutting Pliers
- 1 - 7" (180mm) Combination Pliers / Invisible Spring Pliers

**T28955**

**3pc Pliers Set (Left-Nut Adjustable Wrench)**

Contents:

- 1 - 8" (200mm) Left-Nut Adjustable Wrench
- 1 - 10" (250mm) Lock Grip Pliers





1 - 9-1/2" (240mm) Water Pump Pliers

### T28958

#### 3pc High Leverage Pliers Set

Contents:

- 1 - 8-1/2" Diagonal Cutting Pliers
- 1 - 8-1/2" Linesman Pliers
- 1 - 9" Long Nose Pliers

### T28963

#### 3pc Pliers Set

Contents:

- 1 - 7" (180mm) Heavy Duty Cutting Pliers
- 1 - 8" (200mm) Heavy Duty Lineman Pliers
- 1 - 10" (250mm) Groove Joint Pliers

### T28964

#### 12pc Master Pliers Set

Contents:

- 3 - Adjustable Wrenches:
  - 6" (150mm), 8" (200mm), 10" (250mm)
- 1 - 7" (180mm) Heavy-Duty Cutting Pliers
- 1 - 8" (200mm) Long Nose Pliers
- 1 - 8" (200mm) Combination Pliers
- 1 - 10" (250mm) Lock Grip Pliers
- 1 - 10" (250mm) Groove Joint Pliers
- 1 - 14" (355mm) Aluminum Pipe Wrench
- 1 - 7" (180mm) Straight Nose Internal Pliers
- 1 - 7" (180mm) Straight Nose External Pliers
- 1 - Aviation Tin Snip (Straight Cut)

### T28965

#### 3pc Long Reach Pliers Set

Contents:

- 1 - Long Reach Long Nose Pliers
- 1 - Long Reach Bent Nose Pliers (45 Degree)
- 1 - Long Reach Bent Nose Pliers (90 Degree)

### T28966

#### 3pc Long Reach Hose Grip Pliers Set

Contents:

- 1 - Long Reach 5/16" Hose Grip Pliers
- 1 - Long Reach 1/2" Hose Grip Pliers
- 1 - Long Reach 3/4" Hose Grip Pliers

### T29245

#### 5pc Measuring Tool Set

Contents:

- 1 - Stainless Steel Vernier Caliper (0-6"-1/1000)
- 1 - Micrometer: 0-25mm
- 1 - Precision Square: 150 x 100mm
- 1 - Steel Ruler: 150mm
- 1 - Scriber (Tc-Tipped): 150mm

### T29587

#### 5pc Wood Chisel & Rasp File Set

Contents:

- 1 - 8" (200mm) Round Wood Rasp File
- 1 - 8" (200mm) Flat Wood Rasp File
- 3 - Wood Chisels: 12, 19, 25mm

### T29642

#### 11pc Punch & Chisel Set

Contents:

- 5 - Pin Punches: 2 x 140, 3 x 150, 4 x 180, 5 x 200, 6 x 210mm
- 3 - Taper Punches: 4 x 185, 5 x 185, 6 x 185mm
- 1 - Center Punch: 2.5 x 185mm
- 2 - Cold Chisels: 12 x 160, 16 x 170mm

### T29654

#### 11pc Punch & Chisel Set

Contents:

- 5 - Pin Punches: 2 x 140, 3 x 150, 4 x 180, 5 x 200, 6 x 210mm
- 3 - Taper Punches: 4 x 185, 5 x 185, 6 x 185mm
- 1 - Center Punch: 2.5 x 185mm
- 2 - Cold Chisels: 12 x 160, 16 x 170mm

### T29656

#### 14pc Punch and Chisel Set

Contents:

- 3 - Flat Chisels: 10, 12, 15mm
- 2 - Center Punches: 3, 5mm
- 2 - Taper Punches: 3, 5mm
- 7 - Pin Punches (150mm): 2, 3, 4, 5, 6, 8, 10mm

### T30902

#### 65pc Riveter Set

Contents:

- 1 - Heavy Duty Swivel Head Hand Riveter (T30905)
- 15 - Aluminum Rivets: 2.5mm (3/32")
- 15 - Aluminum Rivets: 3.2mm (1/8")
- 15 - Aluminum Rivets: 4.0mm (5/32")
- 15 - Aluminum Rivets: 4.8mm (3/16")
- 4 - Drills

### T46062

#### 4pc Cutters and Scraper Set

Contents:

- 1 - "Straight Cut" Aviation Tin Snips
- 1 - 8" Multi-Purpose Angled Shear
- 1 - PVC Pipe Cutter
- 1 - Stubby Scraper

### T32093

#### 7pc Super Grip Screwdriver Set (Star)

Contents:

- Star: T10, T15, T20, T25, T27, T30, T40

### T32095

#### 8pc Super Grip Screwdriver Set (PH & Slotted)

Contents:

- 4 - Phillips: #1 x 80mm (3"), #2 x 100mm (4"), #2 x 38mm (1-1/2"), #3 x 150mm (6")
- 4 - Slotted: 4 x 80, 5.5 x 125, 6.5 x 38, 6.5mm x 150mm

### T32098

#### 7pc Super Grip Screwdriver Set (PH & Slotted)

Contents:

- 2 - Phillips: #1 x 80, #2 x 100mm
- 5 - Slotted: 3 x 60, 4 x 80, 5.5 x 125, 6.5 x 150, 8mm x 150mm

### T32157

#### 17pc Precision Screwdriver Set

Contents:

- 1 - Gearless Extendable Bit Driver (1" - 3-3/4")
- 4 - Precision Screwdrivers:
  - 2 - Phillips: #0, #1
  - 2 - Slotted: 2.5mm, 3.0mm
- 12 - Screwdriver Bits:
  - 3 - Phillips: #00, #0, #1
  - 3 - Slotted: 1.0, 1.5, 2.5mm
  - 4 - Star: T5, T6, T7, T8
  - 2 - Hex: 1.5, 2.0mm

### T32164

#### 7pc Electronic Screwdriver Set (VDE1000V)

Contents:

- 3 - Phillips: #0 x 75, #1 x 80, #2 x 100mm
- 4 - Slotted: 0.4 x 2.5 x 75, 0.8 x 4 x 100, 1 x 5.5 x 125, 1.2 x 6.5 x 150mm

### T32173

#### 7pc Electronic Screwdriver Set (VDE1000V)

Contents:

- 3 - Phillips: #0 x 75, #1 x 80, #2 x 100mm
- 4 - Slotted: 0.4 x 2.5 x 75, 0.8 x 4 x 100, 1 x 5.5 x 125, 1.2 x 6.5 x 150mm

**T32179**

**8pc Pry & Wrecking Bar Set**

Contents:

- 4 - Pry Bar Set: 8", 12", 18", 24"
- 4 - Pry Bar & Wrecking Bar Set:
  - 1 - 15" x 1-3/8" x 1/4" Flat Pry Bar (380 x 35 x 6mm)
  - 1 - 16" x 5/8" Wrecking Bar (400 x 16mm)
  - 1 - 10" x 23/32" Cold Chisel (250 x 18mm)
  - 1 - 24" x 3/4" Aligning Bar (600 x 19mm)

**T32185**

**6pc Go-Thru Screwdriver Set (PH & Slotted)**

Contents:

- 3 - Phillips: #1 x 75, #2 x 100, #3 x 150mm
- 3 - Slotted: 5.5 x 100, 6.5 x 150, 8.0mm x 175mm

**T32190**

**8pc Electrical Screwdriver Set (VDE1000V)**

Contents:

- 3 - Phillips: #0 x 75, #1 x 100, #2 x 100mm
- 4 - Slotted: 3.0 x 75, 4.0 x 100, 5.5 x 125, 6.5mm x 150mm
- 1 - Circuit Tester: 120V ~ 250V

**T32191**

**8pc Electrical Screwdriver Set (VDE1000V)**

Contents:

- 3 - Phillips: #0 x 75, #1 x 100, #2 x 100mm
- 4 - Slotted: 3.0 x 75, 4.0 x 100, 5.5 x 125, 6.5 x 150mm
- 1 - Circuit tester: 120V - 250V

**T32791**

**7pc "Power Grip" Screwdriver Set (PH & Slotted)**

Contents: (Chrome Molybdenum Steel)

- 4 - Slotted: 4.0 x 80, 5.5 x 125, 6.5 x 150, 8.0mm x 200mm
- 3 - Phillips: #1 x 80mm, #2 x 100mm, #3 x 150mm

**T32793**

**8pc "Power Grip" Screwdriver Set (PH & Slotted)**

Contents: (Chrome Molybdenum Steel)

- 4 - Slotted: 4.0 x 80, 5.5 x 125, 6.5 x 38, 6.5mm x 150mm
- 4 - Phillips: #1 x 80mm, #2 x 38mm, #2 x 100mm, #3 x 150mm

**T32794**

**5pc Screwdriver Set (PH & Slotted)**

Contents:

- 3 - Slotted: 4 x 80, 5.5 x 125, 6.5 x 100mm
- 2 - Phillips: #1 x 80, #2 x 100mm

**T32795**

**7pc "Power Grip" Screwdriver Set (PH & Slotted)**

Contents: (Chrome Molybdenum Steel)

- 4 - Slotted: 4.0 x 80, 5.5 x 125, 6.5 x 150, 8.0mm x 200mm
- 3 - Phillips: #1 x 80mm, #2 x 100mm, #3 x 150mm

**T32894**

**8pc Comfort Grip Screwdriver Set (PH & Slotted)**

Contents:

- 4 - Slotted: 1/8" x 3", 3/16" x 4", 1/4" x 6", 5/16" x 8"
- 4 - Phillips: #0 x 3", #1 x 4", #2 x 4", #3 x 6"

**T33224**

**22pc 1/2" Dr. Star Bit Sockets and External Star Socket Set**

Contents:

- 9 - 1/2" Dr. Star Bit Sockets:
  - T20, T25, T27, T30, T40, T45, T50, T55, T60
- 4 - 1/2" Dr. Star Bit Sockets (100mm):

T40, T45, T50, T55

9 - 1/2" Dr. External Star Sockets:

E10, E11, E12, E14, E16, E18, E20, E22, E24

**T33225**

**20pc 1/2" Dr. Hex Bit Socket Set**

Contents:

- 10 - 1/2" Dr. Hex Bit Sockets:
  - 4, 5, 6, 7, 8, 10, 12, 14, 17, 19mm
- 10 - 1/2" Dr. Hex Bit Sockets (100mm):
  - 4, 5, 6, 7, 8, 10, 12, 14, 17, 19mm

**T33226**

**22pc 1/2" Dr. Star Bit Socket and External Star Socket Set**

Contents:

- 9 - 1/2" Dr. Star Bit Sockets:
  - T20, T25, T27, T30, T40, T45, T50, T55, T60
- 4 - 1/2" Dr. Star Bit Sockets (100mm):
  - T40, T45, T50, T55
- 9 - 1/2" Dr. External Star Sockets:
  - E10, E11, E12, E14, E16, E18, E20, E22, E24

**T33273**

**34pc Bits & Magnetic Tray Set**

Contents:

- 1 - 4" Stainless Steel Magnetic Tray - Round
- 1 - Flex Ratcheting Screwdriver W/Lock
- 32 - Professional 1/4" Screwdriver Bit Set
  - 30 - 1/4" Screwdriver Bits (25mm):
    - 4 - Phillips: #1, #2 (2pc), #3
    - 4 - Slotted: 3, 4, 5, 6mm
    - 4 - Pozi: #1, #2 (2pc), #3
    - 4 - Hex: 3, 4, 5, 6mm
    - 7 - Star: T10, T15, T20, T25, T27, T30, T40
    - 7 - Tamper-Proof Star: T10, T15, T20, T25, T27, T30, T40
  - 1 - 1/4" Dr. Bit Adaptor
  - 1 - 1/4" Dr. Quick Release Bit Coupler

**T35901**

**17pc Tap & Die Set**

Contents:

- 7 - Taps:
  - M3 x 0.5, M4 x 0.7, M5 x 0.8, M6 x 1.0, M8 x 1.25, M10 x 1.5, M12 x 1.75
- 7 - Dies:
  - M3 x 0.5, M4 x 0.7, M5 x 0.8, M6 x 1.0, M8 x 1.25, M10 x 1.5, M12 x 1.75
- 1 - Taper Wrench (M3 - M12)
- 1 - Die Stock (25mm)
- 1 - Screw Pitch Gauge

**T39820**

**3pc Adjustable Wrench Set**

Contents:

6", 8", 10"

**T39821**

**3pc Adjustable Wrench Set**

Contents:

6", 8", 10"

**T40090**

**8pc Combination Wrench Set (5/16" - 3/4")**

Contents:

5/16", 3/8", 7/16", 1/2", 9/16", 5/8", 11/16", 3/4"

**T40171**

**8pc Combination Wrench Set (10 - 19mm)**

Contents:

10, 11, 12, 13, 14, 15, 17, 19mm

**T40179****18pc Combination Wrench & Hex Key Set**

Contents:

- 9 - Combination Wrenches:  
8, 10, 12, 13, 14, 16, 17, 18, 19mm
- 9 - Hex Key Set:  
1.5, 2, 2.5, 3, 4, 5, 6, 8, 10mm

**T40182****16pc Combination Wrench Set (15° Offset)**

Contents:

- 6, 7, 8, 9, 10, 11, 12, 13, 14, 15, 16, 17, 18, 19, 20, 21mm

**T40187****16pc Combination Wrench Set**

Contents:

- 6, 7, 8, 9, 10, 11, 12, 13, 14, 15, 16, 17, 18, 19, 22, 24mm

**T40188****4pc Combination Wrench Set**

Content:

- 27, 29, 30, 32mm

**T40189****5pc Jumbo Combination Wrench Set**

Contents:

- 36, 38, 41, 46, 55mm

**T40192****6pc Combination Wrench Set (15° Offset)**

Contents:

- 22, 23, 24, 25, 26, 27mm

**T40193****7pc Jumbo Combination Wrench Set**

Contents:

- 30, 32, 36, 38, 41, 46, 55mm

**T40593****9pc Open-End Wrench Set**

Content:

- 6 x 7, 8 x 9, 10 x 11, 12 x 13, 14 x 15, 16 x 17, 18 x 19, 20 x 22, 24 x 27mm

**T40596****10pc Open-End Wrench Set (6 x 7 - 30 x 32mm)**

Contents:

- 6 x 7, 8 x 9, 10 x 11, 12 x 13, 14 x 15, 16 x 17, 18 x 19, 20 x 22, 24 x 27, 30 x 32mm

**T40597****11pc Open-End & Ratcheting Box Wrench Set (6 x 7 - 20 x 22mm)**

Contents:

- 8 - Open-End Wrenches:  
6 x 7, 8 x 9, 10 x 11, 12 x 13, 14 x 15, 16 x 17, 18 x 19, 20 x 22mm
- 3 - Ratcheting Box Wrenches:  
8 x 10, 12 x 14, 13 x 15mm

**T40693****6pc "75-Degree Offset" Box Wrench Set**

Contents:

- 8 x 9, 10 x 11, 12 x 13, 14 x 15, 16 x 17, 18 x 19mm

**T40694****6pc "75-Degree Offset" Box Wrench Set (8 x 9 - 18 x 19mm)**

Contents:

- 8 x 9, 10 x 11, 12 x 13, 14 x 15, 16 x 17, 18 x 19mm

**T40941****6pc Flexible Socket Wrench Set**

Content:

- 8 x 9, 10 x 11, 12 x 13, 14 x 15, 16 x 17, 18mm x 19mm

**T41480****11pc Geared Combination Wrench Set**

Contents:

- 10, 12, 13, 14, 15, 16, 17, 18, 19, 21, 22mm

**T41486****14pc Geared Combination Wrench Set (8 - 19mm)**

Contents:

- 12 - Wrenches:  
8, 9, 10, 11, 12, 13, 14, 15, 16, 17, 18, 19mm
- 2 - Adaptors: 1/4" x 13mm, 3/8" x 19mm

**T41489****14pc Geared Combination Wrench Set**

Contents:

- 12 - Wrenches:  
8, 9, 10, 11, 12, 13, 14, 15, 16, 17, 18, 19mm
- 2 - Adaptors: 1/4" x 13mm, 3/8" x 19mm

**T41496****11pc Geared Combination Wrench Set**

Content:

- 5/16", 3/8", 7/16", 1/2", 9/16", 5/8", 11/16", 3/4", 13/16", 7/8", 15/16"

**T41993****5pc Flare Nut Wrench Set**

Contents:

- 9 x 11, 10 x 12, 13 x 14, 15 x 17, 16mm x 18mm

**T42674****14pc Fits-All Combination Wrench Set (6 - 24mm)**

Contents:

- 6, 8, 10, 12, 13, 14, 15, 16, 17, 18, 19, 21, 22, 24mm

**T42676****3pc Fits-All Combination Wrench Set**

Contents:

- 27, 30, 32mm

**T42678****4pc Fits-All Combination Wrench Set**

Content:

- 24, 27, 30, 32mm

**T42677****14pc Fits-All Combination Wrench Set (6 - 24mm)**

Contents:

- 6, 8, 10, 12, 13, 14, 15, 16, 17, 18, 19, 21, 22, 24mm

**T45010****18pc 1/4" Dr. Socket Set (Metric)**

Contents:

- 12 - 1/4" Dr. 6pt Sockets:  
4, 4.5, 5, 5.5, 6, 7, 8, 9, 10, 11, 12, 13mm
- 1 - 1/4" Dr. Quick Release Offset Ratchet
- 1 - 1/4" Dr. Universal Joint
- 2 - 1/4" Dr. Extension Bars: 2", 6" (50, 150mm)
- 1 - 1/4" Dr. Sliding T-Handle
- 1 - 1/4" Dr. Spinner Handle

Metal Case

**T45011****22pc 1/4" Dr. Socket Set (Metric)**

Contents:

- 9 - 1/4" Dr. 6pt Sockets: 4, 5, 6, 7, 8, 9, 10, 11, 12mm
- 7 - 1/4" Dr. 6pt Deep Sockets: 6, 7, 8, 9, 10, 11, 12mm
- 1 - 1/4" Dr. Quick Release Offset Ratchet
- 1 - 1/4" Dr. Finger Ratchet

- 1 - 1/4" Dr. Universal Joint
- 2 - 1/4" Dr. Extension Bars: 2", 6" (50, 150mm)
- 1 - 1/4" Dr. Spinner Handle

Metal Case

#### T45012

#### 48pc 1/4" Dr. Socket Set (Metric)

Contents:

- 10 - 1/4" Dr. 6pt Sockets:
  - 4, 5, 5.5, 6, 7, 8, 9, 10, 11, 13mm
- 6 - 1/4" Dr. 6pt Deep Sockets:
  - 6, 7, 8, 10, 12, 13mm
- 1 - 1/4" Dr. Quick Release Offset Ratchet
- 1 - 1/4" Dr. Universal Joint
- 2 - 1/4" Dr. Extension Bars: 2", 6" (50, 150mm)
- 1 - 1/4" Dr. Flexible Extension: 150mm
- 1 - 1/4" Dr. Sliding T-Handle
- 1 - 1/4" Dr. Spinner Handle
- 1 - 1/4" Dr. x 1/4" Bit Holder
- 20 - 1/4" Screwdriver Bits (25mm):
  - 4 - Phillips: #0, #1, #2, #3
  - 4 - Slotted: 4, 5.5, 7, 8mm
  - 7 - Star: T10, T15, T20, T25, T27, T30, T40
  - 5 - Hex: 3, 4, 5, 6, 8mm
- 4 - Hex Keys 1.27, 1.5, 2, 2.5

Metal Case

#### T45013

#### 48pc 1/4" Dr. Socket & Bit Set (Metric)

Contents:

- 10 - 1/4" Dr. 6pt Sockets (Metric):
  - 4, 5, 5.5, 6, 7, 8, 9, 10, 11, 13mm
- 6 - 1/4" Dr. 6pt Deep Sockets (Metric):
  - 6, 7, 8, 10, 12, 13mm
- 2 - 1/4" Dr. Extension Bars: 2", 6" (50, 150mm)
- 1 - 1/4" Dr. Flex Extension: 150mm
- 1 - 1/4" Dr. Spinner Handle
- 1 - 1/4" Dr. Universal Joint
- 1 - 1/4" Dr. x 4-1/2" Sliding T-Handle (115mm)
- 1 - 1/4" Dr. Quick Release Offset Ratchet
- 1 - Bit Holder: 1/4" Dr. x 1/4"
- 4 - Hex Key (Metric):
  - 1.27, 1.5, 2, 2.5mm
- 20 - 1/4" Bit Set (25mm):
  - 4 - Phillips: #0, #1, #2, #3
  - 4 - Slotted: 4, 5.5, 7, 8mm
  - 7 - Star: T10, T15, T20, T25, T27, T30, T40
  - 5 - Hex: 3, 4, 5, 6, 8mm

#### T45014

#### 18pc 1/4" Dr. Socket Set (Metric)

Contents:

- 12 - 1/4" Dr. 6pt Sockets:
  - 4, 4.5, 5, 5.5, 6, 7, 8, 9, 10, 11, 12, 13mm
- 1 - 1/4" Dr. Quick Release Ratchet
- 1 - 1/4" Dr. Universal Joint
- 2 - 1/4" Dr. Extension Bars: 2", 4" (50, 100mm)
- 1 - 1/4" Dr. Sliding T-Handle
- 1 - 1/4" Dr. Spinner Handle

Metal Case

#### T45030

#### 37pc 1/4" Dr. Socket Set (Metric)

Contents:

- 10 - 1/4" Dr. 6pt Sockets:
  - 5.5, 6, 7, 8, 9, 10, 11, 12, 13, 14mm
- 1 - 1/4" Dr. Quick Release Offset Ratchet (T29860)
- 1 - 1/4" Dr. x 6" Spinner Handle
- 1 - 1/4" Dr. Sliding T-Handle
- 2 - 1/4" Dr. Extension Bars: 50, 150mm
- 1 - 1/4" Dr. Universal Joint

- 9 - Hex Key Wrenches:
  - 1.5, 2, 2.5, 3, 4, 5, 6, 8, 10mm
- 11 - 1/4" Screwdriver Bits (25mm)
  - 2 - Phillips: #1, #2
  - 2 - Slotted: 5, 7mm
  - 2 - Pozi: #1, #2
  - 2 - Hex: 5, 6mm
  - 3 - Star: T10, T15, T20

#### T45032

#### 35pc 1/4" Dr. Socket & Bit Set (Metric)

Contents:

- 10 - 1/4" Dr. 6pt Sockets:
  - 5.5, 6, 7, 8, 9, 10, 11, 12, 13, 14mm
- 7 - 1/4" Dr. 6pt Deep Sockets:
  - 6, 7, 8, 10, 11, 12, 13mm
- 1 - 1/4" Dr. Quick Release Ratchet (T29860)
- 2 - 1/4" Dr. Extension Bars: 2", 6" (56mm, 150mm)
- 1 - 1/4" Dr. Spinner Handle
- 1 - 1/4" Dr. x 1/4" Bit Holder (T12003)
- 1 - 1/4" Dr. Universal Joint (T33300)
- 1 - 1/4" Dr. x 4-1/2" Sliding T-Handle (115mm)
- 11 - 1/4" Screwdriver Bits (25mm)
  - 2 - Phillips: #1, #2
  - 2 - Slotted: 5, 7mm
  - 2 - Pozi: #1, #2
  - 2 - Hex: 5, 6mm
  - 3 - Star: T10, T15, T20

#### T45033

#### 31pc 1/4" Dr. Socket Set (Metric)

Contents:

- 13 - 1/4" Dr. Sockets:
  - 4, 4.5, 5, 5.5, 6, 7, 8, 9, 10, 11, 12, 13, 14mm
- 2 - 1/4" Dr. Extension Bars: 50, 150mm
- 1 - 1/4" Dr. Spinner Handle
- 1 - 1/4" Dr. Universal Joint
- 1 - 1/4" Dr. x 4-1/2" Sliding T-Handle (115mm)
- 1 - 1/4" Dr. Quick Release Offset Ratchet
- 1 - Bit Holder: 1/4" Dr. x 1/4"
- 11 - 1/4" Screwdriver Bits (25mm)
  - 2 - Phillips: #1, #2
  - 2 - Slotted: 5, 7mm
  - 2 - Pozi: #1, #2
  - 2 - Hex: 5, 6mm
  - 3 - Star: T10, T15, T20

#### T45070

#### 38pc 1/4" Dr. Socket Set (Metric)

Contents:

- 11 - 1/4" Dr. 6pt Sockets:
  - 4, 5, 5.5, 6, 7, 8, 9, 10, 11, 12, 13mm
- 6 - 1/4" Dr. 6pt Deep Sockets: 6, 7, 8, 10, 12, 13mm
- 1 - 1/4" Dr. Quick Release Ratchet (T29836)
- 1 - 1/4" Dr. Universal Joint
- 2 - 1/4" Dr. Extension Bars: 2", 6" (50, 150mm)
- 1 - 3/8" (F) x 1/4" (M) Sliding T-Bar Adaptor
- 1 - Bit Holder: 1/4" Dr. x 1/4"
- 11 - 1/4" Screwdriver Bits (25mm)
  - 2 - Phillips: #1, #2
  - 2 - Hex: 5, 6mm
  - 2 - Slotted: 4, 5.5mm
  - 2 - Pozi: #1, #2
  - 3 - Star: T10, T15, T20
- 4 - Hex Keys: 1.27, 1.5, 2, 2.5

Blowcase

#### T45085

#### 40pc 1/4" Dr. Socket Set (SAE & Metric)

Contents:

- 23 - 1/4" Dr. 6pt Sockets:





- 4, 4.5, 5, 5.5, 6, 7, 8, 9, 10, 11, 12, 13mm
- 5/32", 3/16", 7/32", 1/4", 9/32", 5/16", 11/32", 3/8", 7/16", 1/2", 9/16"
- 1 - 1/4" Dr. Quick Release Ratchet (T29860)
- 2 - 1/4" Dr. Extension Bars: 2", 6" (50, 150mm)
- 1 - 1/4" Dr. Spinner Handle
- 1 - 1/4" Dr. x 1/4" Bit Holder (T12003)
- 1 - 1/4" Dr. Universal Joint (T33300)
- 11 - 1/4" Screwdriver Bits (25mm)
  - 2 - Phillips: #1, #2
  - 2 - Slotted: 5, 7mm
  - 2 - Square Robertson: #1, #2
  - 2 - Hex: 5, 6mm
  - 3 - Star: T10, T15, T20

### T45110

#### 16pc 1/4" Dr. Socket Set (SAE)

Contents:

- 10 - 1/4" Dr. 6pt Sockets:
  - 5/32", 3/16", 7/32", 1/4", 9/32", 5/16", 11/32", 3/8", 7/16", 1/2"
- 1 - 1/4" Dr. Quick Release Offset Ratchet
- 1 - 1/4" Dr. Universal Joint
- 2 - 1/4" Dr. Extension Bars: 2", 6" (50, 150mm)
- 1 - 1/4" Dr. Sliding T-Handle
- 1 - 1/4" Dr. Spinner Handle

Metal Case

### T45111

#### 22pc 1/4" Dr. Socket Set (SAE)

Contents:

- 9 - 1/4" Dr. 6pt Sockets:
  - 3/16", 7/32", 1/4", 9/32", 5/16", 11/32", 3/8", 7/16", 1/2"
- 7 - 1/4" Dr. 6pt Deep Sockets:
  - 1/4", 9/32", 5/16", 11/32", 3/8", 7/16", 1/2"
- 1 - 1/4" Dr. Quick Release Offset Ratchet
- 1 - 1/4" Dr. Finger Ratchet
- 1 - 1/4" Dr. Universal Joint
- 2 - 1/4" Dr. Extension Bars: 2", 6" (50, 150mm)
- 1 - 1/4" Dr. Spinner Handle

Metal Case

### T45120

#### 52pc 1/4" & 3/8" Dr. Socket Set (Metric)

Contents:

- 12 - 1/4" Dr. 6pt Sockets:
  - 4.5, 5, 5.5, 6, 7, 8, 9, 10, 11, 12, 13, 14mm
- 10 - 3/8" Dr. 6pt Sockets:
  - 10, 11, 12, 13, 14, 15, 16, 17, 18, 19mm
- 2 - Quick Release Offset Ratchets: 1/4" Dr. & 3/8" Dr.
- 2 - Extension Bars: 1/4" Dr x 6", 3/8" Dr. x 3"
- 2 - Universal Joints: 1/4" Dr. & 3/8" Dr.
- 1 - 1/4" Dr. Go-Thru Spinner Handle
- 1 - 1/4" Bit Holder
- 22 - 1/4" Bits:
  - 9 - Slotted: 3, 4 (2pc), 5 (2pc), 5.5, 6, 7mm (2pc)
  - 5 - Phillips: #1, #2 (2pc), #3 (2pc)
  - 2 - Pozzi: #2, #3
  - 4 - Star: T10, T15, T20, T25
  - 2 - Hex: 4, 5mm

### T45207

#### 13pc 3/8" & 1/2" Dr. Deep Socket Set (Metric)

Contents:

- 5 - 3/8" Dr. 6pt Deep Sockets:
  - 7, 8, 9, 10, 11mm
- 8 - 1/2" Dr. 6pt Deep Sockets:
  - 12, 13, 14, 15, 16, 17, 18, 19mm

### T45208

#### 23pc 3/8" & 1/2" Dr. Deep Socket, Spark Plug Socket & Stud Puller Set

Contents:

- 5 - 3/8" Dr. 6pt Deep Sockets:
  - 7, 8, 9, 10, 11mm
- 8 - 1/2" Dr. 6pt Deep Sockets:
  - 12, 13, 14, 15, 16, 17, 18, 19mm
- 2 - 1/2" Dr. Spark Plug Sockets: 16, 21mm
- 4 - Stud Pullers (SAE): 3/8" Dr.: 1/4", 5/16";
  - 1/2" Dr.: 3/8", 7/16"
- 4 - Stud Pullers (Metric): 3/8" Dr.: 6, 8mm;
  - 1/2" Dr.: 10, 12mm

### T45210

#### 16pc 3/8" Dr. Socket Set (Metric)

Contents:

- 11 - 3/8" Dr. 6pt Sockets:
  - 8, 10, 11, 12, 13, 14, 15, 17, 19, 21, 22 mm
- 1 - 3/8" Dr. Quick Release Offset Ratchet (T29861)
- 1 - 3/8" Dr. Universal Joint
- 2 - 3/8" Dr. Extension Bars: 3", 6" (75, 150mm)
- 1 - 3/8" Dr. Sliding T-Handle

Metal Case

### T45211

#### 21pc 3/8" Dr. Socket Set (Metric)

Contents:

- 9 - 3/8" Dr. 6pt Sockets:
  - 9, 10, 11, 12, 13, 14, 15, 17, 19mm
- 8 - 3/8" Dr. 6pt Deep Sockets:
  - 10, 11, 12, 13, 14, 15, 17, 19mm
- 1 - 3/8" Dr. Quick Release Offset Ratchet (T29861)
- 1 - 3/8" Dr. Universal Joint
- 2 - 3/8" Dr. Extension Bars: 1-3/4", 3" (45, 75mm)

Metal Case

### T45212

#### 24pc 3/8" Dr. Socket Set (Metric)

Contents:

- 17 - 3/8" Dr. 6pt Sockets:
  - 6, 7, 8, 9, 10, 11, 12, 13, 14, 15, 16, 17, 18, 19, 20, 21, 22 mm
- 1 - 3/8" Dr. Quick Release Offset Ratchet (T29861)
- 1 - 3/8" Dr. Universal Joint
- 2 - 3/8" Dr. Spark Plug Sockets: 16mm, 21mm
- 2 - 3/8" Dr. Extension Bars: 3", 6" (75, 150mm)
- 1 - 3/8" Dr. Sliding T-Handle

Metal Case

### T45230

#### 14pc 3/8" Dr. Socket Set (Metric)

Contents:

- 7 - 3/8" Dr. 12pt Sockets: 10, 11, 12, 13, 14, 15, 17mm
- 4 - 3/8" Dr. 12pt Deep Sockets: 12, 13, 14, 15mm
- 1 - 3/8" Dr. Quick Release Offset Ratchet (T49834)
- 1 - 3/8" Dr. Spark Plug Socket: 16mm
- 1 - 3/8" Dr. Extension Bar: 3" (75mm)

Blowcase

### T45231

#### 26pc 3/8" Dr. Socket Set (Metric)

Contents:

- 10 - 3/8" Dr. 6pt Sockets:
  - 10, 11, 12, 13, 14, 15, 16, 17, 18, 19mm
- 10 - 3/8" Dr. 6pt Deep Sockets:
  - 10, 11, 12, 13, 14, 15, 16, 17, 18, 19mm
- 1 - 3/8" Dr. Quick Release Offset Ratchet (T29861)
- 1 - 3/8" Dr. Universal Joint
- 2 - 3/8" Dr. Spark Plug Sockets: 16, 21mm
- 2 - 3/8" Dr. Extension Bars: 3", 6" (75, 150mm)

Blowcase

**T45239**
**16pc 3/8" Dr. Socket Set (Metric)**

## Contents

- 12 - 3/8" Dr. Sockets:
  - 8, 9, 10, 11, 12, 13, 14, 15, 16, 17, 18, 19mm
- 1 - 3/8" Dr. Quick Release Offset Ratchet
- 1 - 3/8" Dr. Sliding T-Handle: 165mm
- 1 - 3/8" Dr. Universal Joint
- 1 - 3/8" Dr. Extension Bar: 75mm

**T45240**
**19pc 3/8" Dr. Socket Set (Metric)**

## Contents:

- 14 - 3/8" Dr. 6pt Sockets:
  - 8, 9, 10, 11, 12, 13, 14, 15, 16, 17, 18, 19, 21, 22mm
- 1 - 3/8" Dr. Quick Release Offset Ratchet
- 1 - 3/8" Dr. Universal Joint
- 2 - 3/8" Dr. Extension Bars: 3", 6" (75, 150mm)
- 1 - 3/8" Dr. x 165mm Sliding T-Handle

**T45260**
**59pc 3/8" Dr. Socket and Bit Set (Metric)**

## Contents:

- 14 - 3/8" Dr. 6pt Sockets:
  - 8, 9, 10, 11, 12, 13, 14, 15, 16, 17, 18, 19, 21, 22mm
- 6 - 3/8" Dr. 6pt Deep Sockets:
  - 8, 10, 12, 13, 17, 19mm
- 1 - 3/8" Dr. Quick Release Offset Ratchet (T29861)
- 1 - 3/8" Dr. Universal Joint
- 2 - 3/8" Dr. Spark Plug Sockets: 16, 21mm
- 2 - 3/8" Dr. Extension Bars: 3", 6" (75, 150mm)
- 1 - 3/8" Dr. Sliding T-Handle: 6-1/2"
- 1 - 3/8" Dr. x 5/16" Bit Holder
- 27 - 5/16" Screwdriver Bits (30mm)
  - 3 - Phillips: #1, #2, #3
  - 4 - Slotted: 5.5, 7, 8, 10mm
  - 10 - Star: T10, T15, T20, T25, T27, T30, T40, T45, T50, T55
  - 7 - Hex 3, 4, 5, 6, 7, 8, 10mm
  - 3 - Pozi #1, #2, #3
- 4 - Hex Keys 1.27, 1.5, 2, 2.5mm

## Blowcase

**T45270**
**40pc 3/8" Dr. Socket Set (Metric)**

## Contents:

- 14 - 3/8" Dr. 6pt Sockets:
  - 8, 9, 10, 11, 12, 13, 14, 15, 16, 17, 18, 19, 21, 22mm
- 6 - 3/8" Dr. 6pt Deep Sockets:
  - 8, 10, 12, 13, 17, 19mm
- 1 - 3/8" Dr. Quick Release Ratchet (T29837)
- 1 - 3/8" Dr. Universal Joint
- 2 - 3/8" Dr. Spark Plug Sockets: 16, 21mm
- 2 - 3/8" Dr. Extension Bars: 3", 6" (75, 150mm)
- 1 - 1/2" (F) x 3/8" (M) Sliding T-Adaptor
- 1 - 3/8" Dr. x 5/16" Bit Holder
- 12 - 5/16" Screwdriver Bits (30mm):
  - 2 - Phillips: #1, #2
  - 3 - Hex: 5, 6, 8mm
  - 2 - Slotted: 6, 8mm
  - 2 - Pozi: #1, #2
  - 3 - Star: T20, T25, T30

## Blowcase

**T45285**
**22pc 3/8" Dr. Socket Set (SAE & Metric)**

## Contents:

- 9 - 3/8" Dr. 6pt Sockets:
  - 1/4", 5/16", 3/8", 7/16", 1/2", 9/16", 5/8", 11/16", 3/4"
- 10 - 3/8" Dr. 6pt Sockets:
  - 8, 10, 12, 13, 14, 15, 16, 17, 18, 19mm

- 1 - 3/8" Dr. Quick Release Offset Ratchet
- 1 - 3/8" Dr. Universal Joint
- 1 - 3/8" Dr. Extension Bar: 75mm

**T45320**
**39pc 1/4" & 3/8" Dr. Socket Set (SAE & Metric)**

## Contents:

- 9 - 1/4" Dr. 6pt Sockets:
  - 3/16", 7/32", 1/4", 9/32", 5/16", 11/32", 3/8", 7/16", 1/2"
- 9 - 1/4" Dr. 6pt Sockets:
  - 4.5, 5, 6, 7, 8, 9, 10, 11, 12mm
- 7 - 3/8" Dr. 6pt Sockets:
  - 3/8", 7/16", 1/2", 9/16", 5/8", 11/16", 3/4"
- 9 - 3/8" Dr. 6pt Sockets:
  - 9, 10, 11, 12, 13, 14, 16, 17, 19mm
- 1 - 3/8" Dr. Quick Release Offset Ratchet
- 1 - 3/8" Dr. Spark Plug Socket: 13/16" (21mm)
- 1 - 3/8" Dr. Extension Bar: 3" (75mm)
- 1 - 3/8" (F) x 1/4" (M) Socket Adaptor
- 1 - 1/4" Dr. Spinner Handle

## Metal Case

**T45330**
**14pc 3/8" Dr. Socket Set (SAE)**

## Contents:

- 7 - 3/8" Dr. 12pt Sockets:
  - 3/8", 7/16", 1/2", 9/16", 5/8", 11/16", 3/4"
- 4 - 3/8" Dr. 12pt Deep Sockets:
  - 3/8", 7/16", 1/2", 9/16"
- 1 - 3/8" Dr. Quick Release Offset Ratchet (T49834)
- 1 - 3/8" Dr. Spark Plug Socket: 5/8"
- 1 - 3/8" Dr. Extension Bar: 3"

## Blowcase

**T45331**
**24pc 3/8" Dr. Socket Set (SAE)**

## Contents:

- 9 - 3/8" Dr. 6pt Sockets:
  - 1/4", 5/16", 3/8", 7/16", 1/2", 9/16", 5/8", 11/16", 3/4"
- 9 - 3/8" Dr. 6pt Deep Sockets:
  - 1/4", 5/16", 3/8", 7/16", 1/2", 9/16", 5/8", 11/16", 3/4"
- 1 - 3/8" Dr. Quick Release Offset Ratchet
- 1 - 3/8" Dr. Universal Joint
- 2 - 3/8" Dr. Spark Plug Sockets: 5/8", 13/16"
- 2 - 3/8" Dr. Extension Bars: 3", 6"

## Blowcase

**T45408**
**21pc 1/2" Dr. Socket Set (Metric)**

## Contents:

- 14 - 1/2" Dr. Sockets:
  - 10, 12, 13, 14, 15, 16, 17, 18, 19, 22, 24, 27, 30, 32mm
- 1 - 1/2" Dr. Quick Release Offset Ratchet
- 1 - 1/2" Dr. Universal Joint
- 2 - 1/2" Dr. Extension Bars: 125, 250mm
- 1 - 1/2" (F) x 3/8" (M) Sliding T-Handle
- 2 - 1/2" Dr. Spark Plug Sockets: 16mm, 21mm

**T45410**
**17pc 1/2" Dr. Socket Set (Metric)**

## Contents:

- 13 - 1/2" Dr. 6pt Sockets:
  - 10, 11, 12, 13, 14, 15, 17, 19, 22, 24, 27, 30, 32mm
- 1 - 1/2" Dr. Quick Release Offset Ratchet
- 2 - 1/2" Dr. Extension Bars: 125, 250mm
- 1 - 1/2" Dr. Flex Handle

## Metal Case

**T45411**
**24pc 1/2" Dr. Socket Set (Metric)**

## Contents:

18 - 1/2" Dr. 6pt Sockets:  
 10, 11, 12, 13, 14, 15, 16, 17, 18, 19, 20, 21, 22, 23, 24, 27,  
 30, 32mm  
 1 - 1/2" Dr. Quick Release Offset Ratchet  
 1 - 1/2" Dr. Universal Joint  
 1 - 1/2" Dr. Spark Plug Socket: 21mm  
 2 - 1/2" Dr. Extension Bars: 125, 250mm  
 1 - 1/2" Dr. Sliding T-Handle  
 Metal Case

### T45412

#### 26pc 1/2" Dr. Socket Set (Metric)

Contents:  
 20 - 1/2" Dr. 6pt Sockets:  
 8, 9, 10, 11, 12, 13, 14, 15, 16, 17, 18, 19, 20, 21, 22, 23, 24,  
 27, 30, 32mm  
 1 - 1/2" Dr. Quick Release Offset Ratchet  
 1 - 1/2" Dr. Universal Joint  
 1 - 1/2" Dr. Spark Plug Socket: 21mm  
 2 - 1/2" Dr. Extension Bars: 125, 250mm  
 1 - 1/2" Dr. x 380mm Flex Handle  
 Metal Case

### T45414

#### 29pc 1/2" Dr. Socket and Star Bit Set (Metric)

Contents:  
 13 - 1/2" Dr. 6pt Sockets:  
 10, 11, 12, 13, 14, 15, 17, 19, 22, 24, 27, 30, 32mm  
 3 - 1/2" Dr. 6pt Deep Sockets: 12, 13, 17mm  
 6 - 1/2" Dr. Star Bit Sockets (55mm):  
 T20, T25, T30, T40, T45, T50  
 1 - 1/2" Dr. Quick Release Offset Ratchet  
 1 - 1/2" Dr. Universal Joint  
 2 - 1/2" Dr. Spark Plug Sockets: 16, 21mm  
 2 - 1/2" Dr. Extension Bars: 125, 250mm  
 1 - 3/8" Dr. (F) x 1/2" (M) Sliding T-Adaptor  
 Metal Case

### T45415

#### 29pc 1/2" Dr. Socket and Hex Bit Set (Metric)

Contents:  
 13 - 1/2" Dr. 6pt Sockets:  
 10, 11, 12, 13, 14, 15, 17, 19, 22, 24, 27, 30, 32mm  
 3 - 1/2" Dr. 6pt Deep Sockets: 12, 13, 17mm  
 6 - 1/2" Dr. Hex Bit Sockets (55mm): 4, 5, 6, 7, 8, 10mm  
 1 - 1/2" Dr. Quick Release Offset Ratchet  
 1 - 1/2" Dr. Universal Joint  
 2 - 1/2" Dr. Spark Plug Sockets: 16, 21mm  
 2 - 1/2" Dr. Extension Bars: 125, 250mm  
 1 - 3/8" Dr. (F) x 1/2" (M) Sliding T-Bar Adaptor  
 Metal Case

### T45416

#### 45pc 3/8" & 1/2" Dr. Socket Set (Metric)

Contents:  
 14 - 3/8" Dr. 6pt Sockets:  
 6, 7, 8, 9, 10, 11, 12, 13, 14, 15, 16, 17, 18, 19mm  
 20 - 1/2" Dr. 6pt Sockets:  
 10, 11, 12, 13, 14, 15, 16, 17, 18, 19, 20, 21, 22, 23, 24, 27, 28,  
 29, 30, 32mm  
 3 - 1/2" Dr. 6pt Sockets: 3/8", 7/16", 1/2"  
 1 - 3/8" Dr. Quick Release Offset Ratchet  
 1 - 1/2" Dr. Quick Release Offset Ratchet  
 2 - 3/8" Dr. Wobble Extension Bars: 150, 230mm  
 2 - 1/2" Dr. Wobble Extension Bars: 125, 250mm  
 1 - 1/2" Dr. x 125mm Extension Bar  
 1 - 1/2" Dr. x 380mm Flex Handle  
 Metal Case

### T45417

#### 60pc 1/4" & 1/2" Dr. Socket and Bit Set (Metric)

#### Contents:

8 - 1/4" Dr. 6pt Sockets: 4, 5, 5.5, 6, 7, 8, 9, 10mm  
 2 - 1/4" Dr. 6pt Deep Sockets: 8, 10mm  
 12 - 1/2" Dr. 6pt Sockets:  
 10, 11, 12, 13, 14, 15, 17, 19, 22, 24, 30, 32mm  
 3 - 1/2" Dr. 6pt Deep Sockets: 12, 13, 17mm  
 11 - 1/4" Bit Sockets (37mm)  
 2 - Phillips: #1, #2  
 2 - Slotted: 4, 5.5mm  
 4 - Star: T10, T20, T25, T30  
 3 - Hex: 4, 5, 6mm  
 8 - 1/2" Dr. Bit Sockets (55mm)  
 1 - Phillips: #3  
 1 - Slotted: 8mm  
 3 - Star: T40, T45, T50  
 3 - Hex: 7, 8, 10mm (100mm)  
 1 - 1/4" Dr. Quick Release Offset Ratchet  
 1 - 1/2" Dr. Quick Release Offset Ratchet  
 2 - Universal Joints: 1/4", 1/2" Dr.  
 2 - 1/2" Dr. Spark Plug Sockets: 16, 21mm  
 2 - 1/4" Dr. Extension Bars: 50, 150mm  
 2 - 1/2" Dr. Extension Bars: 125, 250mm  
 1 - 3/8" Dr. (F) x 1/2" (M) Sliding T-Adaptor  
 1 - 1/4" Dr. Spinner Handle  
 4 - Hex Keys: 1.27, 1.5, 2, 2.5mm  
 Metal Case

### T45425

#### 22pc 1/2" Dr. Socket Set (Metric)

Contents:  
 18 - 1/2" Dr. 6pt Sockets:  
 10, 11, 12, 13, 14, 15, 16, 17, 18, 19, 20, 21, 22, 23, 24, 27,  
 30, 32mm  
 1 - 1/2" Dr. Quick Release Offset Ratchet  
 1 - 1/2" Dr. Universal Joint  
 2 - 1/2" Dr. Extension Bars: 125, 250mm

### T45429

#### 22pc 1/2" Dr. Socket Set (Metric)

Contents:  
 18 - 1/2" Dr. 6pt Sockets:  
 10, 11, 12, 13, 14, 15, 16, 17, 18, 19, 20, 21, 22, 23, 24, 27,  
 30, 32mm  
 1 - 1/2" Dr. Quick Release Offset Ratchet  
 1 - 1/2" Dr. Universal Joint  
 2 - 1/2" Dr. Extension Bars: 125, 250mm

### T45462

#### 70pc 1/4" & 1/2" Dr. Socket and Wrench Set (Metric)

Contents:  
 12 - 1/4" Dr. 6pt Sockets:  
 4, 4.5, 5, 5.5, 6, 7, 8, 9, 10, 11, 12, 13mm  
 16 - 1/2" Dr. 6pt Sockets:  
 10, 11, 12, 13, 14, 15, 16, 17, 18, 19, 20, 21, 22, 23, 24, 27mm  
 1 - 1/4" Dr. Quick Release Offset Ratchet (T29860)  
 1 - 1/2" Dr. Quick Release Offset Ratchet (T29862)  
 2 - Universal Joints: 1/4" Dr., 1/2" Dr.  
 2 - 1/2" Dr. Spark Plug Sockets: 16, 21mm  
 1 - 1/4" Dr. Extension Bar: 4" (100mm)  
 2 - 1/2" Dr. Extension Bars: 5", 10" (125, 250mm)  
 1 - 3/8" Dr. (F) x 1/2" (M) Sliding T-Adaptor  
 10 - Combination Wrenches:  
 8, 9, 10, 11, 12, 13, 14, 15, 17, 19mm  
 1 - 1/4" Dr. Spinner Handle  
 1 - 1/4" Dr. x 1/4" Bit Holder  
 20 - 1/4" Screwdriver Bits (30mm):  
 4 - Phillips: #0, #1, #2, #3  
 4 - Slotted: 4, 5.5, 7, 8mm  
 7 - Star: T10, T15, T20, T25, T27, T30, T40  
 5 - Hex: 3, 4, 5, 6, 8mm

Blowcase

**T45470**

**22pc 1/2" Dr. Socket Set (Metric)**

Contents:

- 16 - 1/2" Dr. 6pt Sockets:
  - 10, 11, 12, 13, 14, 15, 16, 17, 18, 19, 21, 22, 24, 27, 30, 32mm
- 1 - 1/2" Dr. Quick Release Ratchet (T29838)
- 1 - 1/2" Dr. Universal Joint
- 1 - 1/2" Dr. Spark Plug Socket: 21mm
- 2 - 1/2" Dr. Extension Bars: 5", 10" (125, 250mm)
- 1 - 3/8" (F) x 1/2" (M) Sliding T-Adaptor

Blowcase

**T45480**

**80pc 1/4" & 1/2" Dr. Socket Set (Metric)**

Contents:

- 11 - 1/4" Dr. 6pt Sockets:
  - 4, 5, 5.5, 6, 7, 8, 9, 10, 11, 12, 13mm
- 16 - 1/2" Dr. 6pt Sockets:
  - 10, 11, 12, 13, 14, 15, 16, 17, 18, 19, 20, 21, 22, 23, 24, 27mm
- 6 - 1/4" Dr. 6pt Deep Sockets: 6, 7, 8, 10, 12, 13mm
- 1 - 1/4" Dr. Quick Release Ratchet (T29836)
- 1 - 1/2" Dr. Quick Release Ratchet (T29838)
- 1 - 1/2" Dr. Universal Joint
- 1 - 1/2" Dr. Spark Plug Socket: 21mm
- 1 - 1/4" Dr. Extension Bar: 4" (100mm)
- 2 - 1/2" Dr. Extension Bars: 5", 10" (125, 250mm)
- 1 - 1/4" Dr. Flex Extension
- 1 - 3/8" (F) x 1/2" (M) Sliding T-Adaptor
- 1 - 1/4" Dr. x 1/4" Bit Holder
- 4 - Hex Keys: 1.27, 1.5, 2, 2.5mm
- 33 - 1/4" Screwdriver Bits (25mm)
  - 5 - Phillips: #0, #1, #2, #3, #4
  - 4 - Slotted: 3, 4, 5.5, 7mm
  - 11 - Hex: 3, 4, 5, 5.5, 6mm, 1/8", 5/32", 3/16", 7/32", 1/4", 9/32"
  - 8 - Star: T8, T10, T15, T20, T25, T27, T30, T40
  - 3 - Pozi: #1, #2, #3
  - 2 - Spline: 5, 6

Blowcase

**T45486**

**94pc 1/4" & 1/2" Dr. Socket Set (Metric)**

Contents:

- 12 - 1/4" Dr. 6pt Sockets:
  - 4, 4.5, 5, 5.5, 6, 7, 8, 9, 10, 11, 12, 13mm
- 18 - 1/2" Dr. 6pt Sockets:
  - 10, 11, 12, 13, 14, 15, 16, 17, 18, 19, 20, 21, 22, 23, 24, 27, 30, 32mm
- 8 - 1/4" Dr. 6pt Deep Sockets:
  - 6, 7, 8, 9, 10, 11, 12, 13mm
- 4 - 1/2" Dr. 6pt Deep Sockets: 14, 15, 17, 19mm
- 17 - 1/4" Bit Sockets
  - 3 - Slotted: 4, 5.5, 7mm
  - 2 - Phillips: #1, #2
  - 6 - Star: T8, T10, T15, T20, T25, T30
  - 4 - Hex: 3, 4, 5, 6mm
  - 2 - Pozi: #1, #2
- 1 - 1/4" Dr. Quick Release Ratchet (T29836)
- 1 - 1/2" Dr. Quick Release Ratchet (T29838)
- 2 - Universal Joints: 1/4", 1/2" Dr.
- 2 - 1/2" Dr. Spark Plug Sockets: 16, 21mm
- 2 - 1/4" Dr. Extension Bars: 2", 4" (50, 100mm)
- 2 - 1/2" Dr. Extension Bars: 5", 10" (125, 250mm)
- 1 - 3/8" (F) x 1/2" (M) Sliding T-Adaptor
- 1 - 1/4" Dr. Spinner Handle
- 1 - 1/4" Dr. Sliding T-Handle
- 1 - 1/4" Dr. Flex Extension: 150mm
- 4 - Hex Keys: 1.27, 1.5, 2, 2.5mm
- 1 - 1/2" Dr. x 5/16" Bit Holder

- 1 - 1/4" Dr. x 1/4" Bit Adaptor
- 15 - 5/16" Bits (30mm)
  - 3 - Slotted: 8, 10, 12mm
- 2 - Phillips: #3, #4
- 4 - Star: T40, T45, T50, T55
- 4 - Hex: 8, 10, 12, 14mm
- 2 - Pozi: #3, #4

Blowcase

**T45487**

**98pc 1/4" & 1/2" Dr. Tool Set (Metric)**

Contents:

- 14 - 1/4" Dr. 6pt Sockets:
  - 4, 4.5, 5, 5.5, 6, 6.5, 7, 8, 9, 10, 11, 12, 13, 14mm
- 13 - 1/2" Dr. 6pt Sockets:
  - 14, 15, 16, 17, 18, 19, 20, 21, 22, 24, 27, 30, 32mm
- 4 - 1/2" Dr. Deep 6pt Sockets: 14, 15, 17, 19mm
- 1 - 1/4" Dr. Quick Release Offset Ratchet
- 1 - 1/2" Dr. Quick Release Offset Ratchet
- 2 - Universal Joints: 1/4", 1/2" Dr.
- 2 - 1/2" Dr. Spark Plug Sockets: 16, 21mm
- 2 - 1/4" Dr. Extension Bars: 50, 100mm
- 2 - 1/2" Dr. Extension Bars: 125, 250mm
- 1 - 1/2" Dr. (F) x 3/8" (M) Sliding T-Adaptor
- 1 - 1/4" Dr. Sliding T-Handle
- 9 - Combination Wrenches:
  - 8, 10, 11, 12, 13, 14, 17, 19, 22mm
- 5 - Precision Screwdrivers:
  - 2 - Phillips: #00, #0
  - 3 - Slotted: 2, 3, 4mm
- 4 - Screwdrivers:
  - 2 - Phillips: #1 x 75mm, #2 x 100
  - 2 - Slotted: 5 x 100mm, 6 x 150mm
- 1 - 1/4" Dr. Spinner Handle
- 1 - 1/4" Dr. x 1/4" Bit Holder
- 1 - 1/2" Dr. x 5/16" Bit Holder
- 18 - 1/4" Screwdriver Bits (25mm)
  - 3 - Phillips: #0, #1, #2
  - 4 - Slotted: 3, 4, 5, 6mm
  - 6 - Star: T10, T15, T20, T25, T27, T30
  - 3 - Hex: 2.5, 3, 4mm
  - 2 - Pozi: #1, #2
- 16 - 5/16" Screwdriver Bits (30mm)
  - 2 - Phillips: #2, #3
  - 3 - Slotted: 6, 7, 8mm
  - 5 - Star: T25, T27, T30, T40, T45
  - 4 - Hex: 5, 6, 7, 8mm
  - 2 - Pozi: #2, #3

Blowcase

**T45488**

**106pc 1/4" & 1/2" Dr. Socket & Wrench Set (Metric)**

Contents:

- 12 - 1/4" Dr. 6pt Sockets:
  - 4, 4.5, 5, 5.5, 6, 7, 8, 9, 10, 11, 12, 13mm
- 8 - 1/4" Dr. 6pt Deep Sockets:
  - 6, 7, 8, 9, 10, 11, 12, 13mm
- 18 - 1/2" Dr. 6pt Sockets:
  - 10, 11, 12, 13, 14, 15, 16, 17, 18, 19, 20, 21, 22, 23, 24, 27, 30, 32mm
- 4 - 1/2" Dr. 6pt Deep Sockets: 14, 15, 17, 19mm
- 1 - 1/4" Dr. Quick Release Offset Ratchet
- 1 - 1/2" Dr. Quick Release Offset Ratchet
- 2 - Universal Joints: 1/4", 1/2" Dr.
- 2 - 1/2" Dr. Spark Plug Sockets: 16, 21mm
- 2 - 1/4" Dr. Extension Bars: 50, 100mm
- 2 - 1/2" Dr. Extension Bars: 125, 250mm
- 1 - 1/4" Dr. x 150mm Flex Handle
- 1 - 1/4" Dr. Sliding T-Handle
- 1 - 1/2" Dr. (F) x 3/8" (M) Sliding T-Adaptor





- 5 - Combination Wrenches: 10, 12, 13, 14, 17mm
- 9 - Hex Keys: 1.5, 2, 2.5, 3, 4, 5, 6, 8, 10mm
- 1 - 1/4" Dr. Spinner Handle
- 1 - 1/2" x 5/16" Bit Holder
- 19 - 1/4" Bit Sockets:
  - 3 - Phillips: #0, #1, #2
  - 3 - Slotted: 4, 5.5, 7mm
  - 4 - Hex: 3, 4, 5, 6mm
  - 6 - Star: T10, T15, T20, T25, T27, T30
  - 3 - Pozi: #0, #1, #2
- 16 - 5/16" Screwdriver Bits:
  - 2 - Phillips: #2, #3
  - 3 - Slotted: 6, 7, 8mm
  - 4 - Hex: 5, 6, 7, 8mm
  - 5 - Star: T25, T27, T30, T40, T45
  - 2 - Pozi: #2, #3

Blowcase

### T45490

#### 138pc 3/8" & 1/2" Dr. Tool Set (Metric)

Contents:

- 12 - 3/8" Dr. 6pt Sockets: 8, 9, 10, 11, 12, 13, 14, 15, 16, 17, 18, 19mm
- 12 - 3/8" Dr. 6pt Deep Sockets: 8, 9, 10, 11, 12, 13, 14, 15, 16, 17, 18, 19mm
- 14 - 1/2" Dr. 6pt Sockets: 13, 14, 15, 16, 17, 18, 19, 20, 21, 22, 24, 27, 30, 32mm
- 6 - 1/2" Dr. 6pt Deep Sockets: 16, 17, 18, 19, 20, 21mm
- 4 - 1/2" Dr. Air Impact Sockets: 17, 19, 21, 23mm
- 4 - 1/2" Dr. Hex Bit Sockets (100mm): 6, 7, 8, 10mm
- 1 - 3/8" Dr. Quick Release Offset Ratchet
- 1 - 1/2" Dr. Quick Release Offset Ratchet
- 2 - Universal Joints: 3/8", 1/2" Dr.
- 2 - 1/2" Dr. Spark Plug Sockets: 16, 21mm
- 2 - 3/8" Dr. Extension Bars: 75, 150mm
- 2 - 1/2" Dr. Extension Bars: 125, 250mm
- 1 - 3/8" Dr. (F) x 1/4" Dr. (M) Socket Adaptor
- 1 - 3/8" Dr. (F) x 1/2" Dr. (M) Socket Adaptor
- 1 - 1/2" Dr. (F) x 3/8" Dr. (M) Socket Adaptor
- 1 - 3/8" Dr. x 10" (250mm) Flexible Handle
- 1 - 1/2" Dr. x 15" (380mm) Flexible Handle
- 13 - Combination Wrenches: 7, 8, 9, 10, 11, 12, 13, 14, 15, 16, 17, 18, 19mm
- 4 - Swivel Socket Wrenches: 10 x 11, 12 x 13, 14 x 15, 16mm x 17mm
- 10 - 3/8" Dr. Birdfeet Wrenches: 10, 11, 12, 13, 14, 15, 16, 17, 18, 19mm
  - 1 - 150mm Diagonal Cutting Pliers
  - 1 - 150mm Long Nose Pliers
  - 1 - 240mm Water Pump Pliers
- 6 - Precision Screwdrivers:
  - 3 - Phillips: #00 x 75, #0 x 75, #1 x 75mm
  - 3 - Slotted: 2 x 75, 2.5 x 75, 3mm x 75mm
- 1 - 16oz. Soft Hammer
- 1 - Pocket Magnetic Pickup
- 1 - 1/4" Dr. x 1/4" (6mm) Bit Holder
- 1 - 3/8" Dr. x 1/4" (6mm) Bit Holder
- 1 - 1/4" Super Grip Bit Driver (125mm)
- 30 - 1/4" x 1/4" Screwdriver Bits (25mm)
  - 4 - Phillips: #0, #1, #2, #3
  - 7 - Slotted: 3/16", 1/4", 9/32", 4, 5.5, 6, 7mm
  - 8 - Star: T8, T10, T15, T20, T25, T27, T30, T40
  - 4 - Hex: 3, 4, 5, 6mm
  - 3 - Square Robertson: S1, S2, S3
  - 4 - Pozi: #0, #1, #2, #3

Blowcase

### T45495

#### 17pc 1/4", 3/8" & 1/2" Dr. Deep Socket Set (Metric)

Contents:

- 5 - 1/4" Dr. Deep Sockets: 6, 8, 10, 11, 12mm
- 5 - 3/8" Dr. Deep Sockets: 13, 14, 15, 17, 18mm
- 7 - 1/2" Dr. Deep Sockets: 19, 21, 22, 24, 27, 30, 32mm

### T45510

#### 17pc 1/2" Dr. Socket Set (SAE)

Contents:

- 13 - 1/2" Dr. 6pt Sockets: 7/16", 1/2", 9/16", 5/8", 11/16", 3/4", 13/16", 7/8", 15/16", 1", 1-1/16", 1-1/8", 1-1/4"
  - 1 - 1/2" Dr. Quick Release Offset Ratchet (T29862)
  - 2 - 1/2" Dr. Extension Bars: 5", 10"
  - 1 - 1/2" Dr. Flex Handle: 15"
- Metal Case

### T45512

#### 24pc 1/2" Dr. Socket Set (SAE)

Contents:

- 18 - 1/2" Dr. 6pt Sockets: 3/8", 7/16", 15/32", 1/2", 9/16", 19/32", 5/8", 11/16", 3/4", 25/32", 13/16", 7/8", 15/16", 1", 1-1/16", 1-1/8", 1-3/16", 1-1/4"
  - 1 - 1/2" Dr. Quick Release Offset Ratchet (T29862)
  - 1 - 1/2" Dr. Universal Joint
  - 1 - 1/2" Dr. Spark Plug Socket: 13/16"
  - 2 - 1/2" Dr. Extension Bars: 5", 10"
  - 1 - 1/2" Dr. Flex Handle: 15"
- Metal Case

### T45530

#### 27pc 1/2" Dr. Socket Set (SAE)

Contents:

- 15 - 1/2" Dr. 6pt Sockets: 3/8", 7/16", 1/2", 9/16", 5/8", 11/16", 3/4", 13/16", 7/8", 15/16", 1", 1-1/16", 1-1/8", 1-3/16", 1-1/4"
  - 9 - 1/2" Dr. 6pt Deep Sockets: 7/16", 1/2", 9/16", 5/8", 11/16", 3/4", 13/16", 7/8", 15/16"
  - 1 - 1/2" Dr. Quick Release Offset Ratchet (T29862)
  - 2 - 1/2" Dr. Extension Bars: 5", 10"
- Blowcase

### T45531

#### 39pc 1/2" Dr. Mechanics Tool Set (Metric)

Contents:

- 13 - 1/2" Dr. 6pt. Sockets: 10, 11, 12, 13, 14, 15, 16, 17, 18, 19, 20, 22, 24mm
  - 1 - 1/2" Dr. Quick Release Offset Ratchet
  - 1 - 1/2" Dr. Universal Joint
  - 2 - 1/2" Dr. Spark Plug Socket: 16, 21mm
  - 2 - 1/2" Dr. Extension Bars: 5", 10"
  - 1 - 3/8" Dr. (F) x 1/2" Dr. (M) Sliding T-Bar Adaptor
  - 8 - Combination Wrenches: 8, 10, 11, 12, 13, 14, 15, 17mm
  - 1 - 7" Insulated Combination Pliers
  - 1 - 6" Insulated Long Nose Pliers
  - 1 - 6" Insulated Diagonal Cutting Pliers
  - 1 - 10" Insulated Groove Joint Pliers
  - 4 - Insulated Screwdrivers:
    - 2 - Phillips: #1 x 80mm, #2 x 100mm
    - 2 - Slotted: 4 x 100mm, 6.5 x 125mm
  - 1 - 120-250V Circuit Tester
  - 1 - Scissors
  - 1 - 300g Hammer
- Blowcase

### T45532

#### 47pc 1/2" Dr. Socket Set (SAE & Metric)

Contents:



- 17 - 1/2" Dr. 6pt Sockets:  
3/8", 7/16", 1/2", 9/16", 19/32", 5/8", 11/16", 3/4", 25/32",  
13/16", 7/8", 15/16", 1", 1-1/16", 1-1/8", 1-3/16", 1-1/4"
- 22 - 1/2" Dr. 6pt Sockets:  
10, 11, 12, 13, 14, 15, 16, 17, 18, 19, 20, 21, 22, 23, 24, 25,  
26, 27, 28, 29, 30, 32mm
- 1 - 1/2" Dr. Quick Release Offset Ratchet
- 1 - 1/2" Dr. Universal Joint
- 2 - 1/2" Dr. Spark Plug Sockets: 5/8", 13/16"
- 2 - 1/2" Dr. Extension Bars: 5" & 10"
- 1 - 1/2" Dr. Sliding T-Handle: 10" (250mm)
- 1 - 1/2" Dr. Flexible Handle: 15" (380mm)

Blowcase

### T45535

#### 108pc 1/4", 3/8" & 1/2" Dr. Socket Set (SAE & Metric)

Contents:

- 7 - 1/2" Dr. 6pt Sockets:  
3/4", 13/16", 7/8", 15/16", 1", 1-1/16", 1-1/8"
- 8 - 1/2" Dr. 6pt Sockets:  
17, 18, 19, 20, 21, 22, 23, 24mm
- 9 - 3/8" Dr. 6pt Sockets:  
3/8", 7/16", 1/2", 9/16", 5/8", 11/16", 3/4", 13/16", 7/8"
- 10 - 3/8" Dr. 6pt Sockets:  
10, 11, 12, 13, 14, 15, 16, 17, 18, 19mm
- 11 - 1/4" Dr. 6pt Sockets:  
5/32", 3/16", 7/32", 1/4", 9/32", 5/16", 11/32", 3/8", 7/16",  
1/2", 9/16"
- 11 - 1/4" Dr. 6pt Sockets:  
4, 5, 6, 7, 8, 9, 10, 11, 12, 13, 14mm
- 5 - 1/4" Dr. 6pt Deep Sockets: 1/4", 9/32", 5/16", 3/8", 7/16"
- 5 - 1/4" Dr. 6pt Deep Sockets: 7, 8, 9, 10, 11mm
- 4 - 1/2" Dr. 6pt Deep Sockets: 3/4", 13/16", 7/8", 15/16"
- 4 - 1/2" Dr. 6pt Deep Sockets: 17, 18, 19, 21mm
- 5 - 3/8" Dr. 6pt Deep Sockets: 1/2", 9/16", 5/8", 3/4", 13/16"
- 5 - 3/8" Dr. 6pt Deep Sockets: 10, 13, 14, 15, 16mm
- 3 - Universal Joints: 1/4", 3/8", 1/2" Dr.
- 2 - 3/8" Dr. Spark Plug Sockets: 5/8", 13/16"
- 3 - Extension Bars:  
1/4" x 4" (100mm), 3/8" x 6" (150mm), 1/2" x 5" (125mm)
- 1 - 1/2" Dr. Flexible Handle: 15" (380mm)
- 3 - Quick Release Ratchets: 1/4", 3/8", 1/2" Dr.
- 12 - 3/8" Dr. Bit Sockets:  
6 - Hex: 5/16", 3/8", 6, 7, 8, 10mm  
6 - Star: T30, T40, T45, T47, T50, T55

### T45601

#### 44pc 1/4" Dr. Socket Set (SAE & Metric)

Contents:

- 10 - 1/4" Dr. 6pt Sockets:  
5/32", 3/16", 7/32", 1/4", 9/32", 5/16", 11/32", 3/8", 7/16", 1/2"
- 10 - 1/4" Dr. 6pt Sockets:  
5.5, 6, 7, 8, 9, 10, 11, 12, 13, 14mm
- 10 - 1/4" Dr. 6pt Deep Sockets:  
5/32", 3/16", 7/32", 1/4", 9/32", 5/16", 11/32", 3/8", 7/16", 1/2"
- 10 - 1/4" Dr. 6pt Deep Sockets:  
5.5, 6, 7, 8, 9, 10, 11, 12, 13, 14mm
- 1 - 1/4" Dr. Quick Release Offset Ratchet (T29860)
- 1 - 1/4" Dr. Universal Joint
- 2 - 1/4" Dr. Extension Bars: 2", 6" (50, 150mm)

Blowcase

### T45602

#### 55pc 1/4" Dr. Socket Set (SAE & Metric)

Contents:

- 10 - 1/4" Dr. 6pt Sockets:  
5/32", 3/16", 7/32", 1/4", 9/32", 5/16", 11/32", 3/8", 7/16", 1/2"
- 12 - 1/4" Dr. 6pt Sockets:  
4, 4.5, 5, 5.5, 6, 7, 8, 9, 10, 11, 12, 13mm
- 1 - 1/4" Dr. Quick Release Offset Ratchet (T29860)

- 1 - 1/4" Dr. Universal Joint
- 1 - 1/4" Dr. Extension Bar: 3" (75mm)
- 1 - 1/4" Dr. Spinner Handle
- 1 - 1/4" Dr. x 1/4" Bit Coupler
- 24 - 1/4" Screwdriver Bits (25mm)  
4 - Phillips: #0, #1, #2, #3  
5 - Slotted: 5/32", 3/16", 7/32", 1/4", 9/32"  
7 - Star: T10, T15, T20, T25, T27, T30, T40  
5 - Hex: 1/8", 5/32", 3/16", 7/32", 1/4"  
3 - Robertson: R1, R2, R3
- 4 - Bit Holders

Blowcase

### T45603

#### 45pc 1/4" Dr. Socket Set (SAE & Metric)

Contents: (Chrome Vanadium Steel)

- 9 - 1/4" Dr. 6pt Sockets:  
7/32", 1/4", 9/32", 5/16", 11/32", 3/8", 7/16", 1/2", 9/16"
- 12 - 1/4" Dr. 6pt Sockets:  
4, 4.5, 5, 5.5, 6, 7, 8, 9, 10, 11, 12, 13mm
- 8 - 1/4" Dr. 6pt Deep. Socket:  
6, 7, 8, 9, 10, 11, 12, 13mm
- 1 - 1/4" Dr. Quick Release Offset Ratchet
- 1 - 1/4" Dr. Universal Joint
- 1 - 1/4" Dr. Extension Bar: 3" (75mm)
- 1 - 1/4" Dr. Flex Handle: 5-1/2" (140mm)
- 1 - 1/4" Dr. Spinner Handle
- 1 - 1/4" Dr. Bit Holder
- 10 - 1/4" Screwdriver Bits (25mm)  
3 - Phillips: #1, #2, #3  
3 - Slotted: 3/16", 1/4", 9/32"  
3 - Star: T10, T15, T20  
1 - Adaptor

Blowcase

### T45606

#### 45pc 1/4" Dr. Socket Set (SAE & Metric)

Contents: (Chrome Vanadium Steel)

- 9 - 1/4" Dr. 6pt Sockets:  
7/32", 1/4", 9/32", 5/16", 11/32", 3/8", 7/16", 1/2", 9/16"
- 12 - 1/4" Dr. 6pt Sockets:  
4, 4.5, 5, 5.5, 6, 7, 8, 9, 10, 11, 12, 13mm
- 4 - 1/4" Dr. 6pt Deep Sockets: 1/4", 9/32", 5/16", 3/8"
- 4 - 1/4" Dr. 6pt Deep Sockets: 7, 8, 9, 10mm
- 1 - 1/4" Dr. Quick Release Offset Ratchet
- 1 - 1/4" Dr. Universal Joint
- 1 - 1/4" Dr. Extension Bar: 3" (75mm)
- 1 - 1/4" Dr. Flex Handle: 5-1/2" (140mm)
- 1 - 1/4" Dr. Spinner Handle
- 1 - 1/4" Dr. Bit Holder
- 10 - 1/4" Screwdriver Bits (25mm):  
3 - Phillips: #1, #2, #3  
3 - Slotted: 3/16", 1/4", 9/32"  
3 - Star: T10, T15, T20  
1 - 1/4" Bit Adaptor

Blowcase

### T45610

#### 22pc 1/4" Drive Socket Set (SAE & Metric)

Contents:

- 10 - 1/4" Dr. 6pt Sockets:  
5/32", 3/16", 7/32", 1/4", 9/32", 5/16", 11/32", 3/8", 7/16", 1/2"
- 10 - 1/4" Dr. 6pt Sockets:  
4, 5, 6, 7, 8, 9, 10, 11, 12, 13mm
- 1 - 1/4" Dr. Quick Release Offset Ratchet (T49833)
- 1 - 1/4" Dr. Spinner Handle

Blowcase

### T45620

#### 41pc 1/4" & 3/8" Dr. Socket Set (SAE & Metric)



### Contents:

- 10 - 1/4" Dr. 6pt Sockets:  
5/32", 3/16", 7/32", 1/4", 9/32", 5/16", 11/32", 3/8", 7/16", 1/2"
- 7 - 1/4" Dr. 6pt Sockets:  
4, 4.5, 5, 5.5, 6, 7, 8mm
- 7 - 3/8" Dr. 12pt Sockets:  
3/8", 7/16", 1/2", 9/16", 5/8", 11/16", 3/4"
- 11 - 3/8" Dr. 12pt Sockets:  
9, 10, 11, 12, 13, 14, 15, 16, 17, 18, 19mm
- 1 - 1/4" Dr. Quick Release Offset Ratchet (T29860)
- 1 - 3/8" Dr. Quick Release Offset Ratchet (T29861)
- 1 - 3/8" Dr. Spark Plug Socket: 5/8" (16mm)
- 1 - 1/4" Dr. Extension Bar: 2" (50mm)
- 1 - 3/8" Dr. Extension Bar: 3" (75mm)
- 1 - 3/8" (F) x 1/4" (M) Socket Adaptor

### Blowcase

#### T45622

### 35pc 3/8" Dr. Socket Set (SAE & Metric)

### Contents:

- 11 - 3/8" Dr. 12pt Sockets:  
1/4", 5/16", 3/8", 7/16", 1/2", 9/16", 5/8", 11/16", 3/4", 13/16", 7/8"
- 16 - 3/8" Dr. 12pt Sockets:  
6, 7, 8, 9, 10, 11, 12, 13, 14, 15, 17, 18, 19, 20, 21, 22mm
- 1 - 3/8" Dr. Quick Release Offset Ratchet
- 1 - 3/8" Dr. Universal Joint
- 2 - 3/8" Dr. Spark Plug Sockets: 5/8", 13/16" (16, 21mm)
- 3 - 3/8" Dr. Extension Bars: 3", 6", 10" (75, 150, 250mm)
- 1 - 3/8" Dr. Flex Handle: 10" (250mm)

### Blowcase

#### T45652

### 40pc 1/4" & 3/8" Dr. Socket Set (SAE & Metric)

### Contents:

- 10 - 1/4" Dr. 6pt Sockets:  
5/32", 3/16", 7/32", 1/4", 9/32", 5/16", 11/32", 3/8", 7/16", 1/2"
- 7 - 1/4" Dr. 6pt Sockets:  
4, 4.5, 5, 5.5, 6, 7, 8mm
- 7 - 3/8" Dr. 12pt Sockets:  
3/8", 7/16", 1/2", 9/16", 5/8", 11/16", 3/4"
- 11 - 3/8" Dr. 12pt Sockets:  
9, 10, 11, 12, 13, 14, 15, 16, 17, 18, 19mm
- 1 - 3/8" Dr. Quick Release Ratchet (T29837)
- 1 - 3/8" Dr. Spark Plug Socket: 5/8"
- 1 - 3/8" Dr. Extension Bar: 3" (75mm)
- 1 - 1/4" Dr. Spinner Handle
- 1 - 3/8" (F) x 1/4" (M) Socket Adaptor

### Blowcase

#### T45658

### 62pc 1/4" & 3/8" Dr. Socket Set (SAE & Metric)

### Contents:

- 10 - 1/4" Dr. 6pt Sockets:  
5/32", 3/16", 7/32", 1/4", 9/32", 5/16", 11/32", 3/8", 7/16", 1/2"
- 12 - 1/4" Dr. 6pt Sockets: 4, 4.5, 5, 5.5, 6, 7, 8, 9, 10, 11, 12, 13mm
- 3 - 1/4" Dr. 8pt Sockets: 1/4", 5/16", 3/8"
- 8 - 3/8" Dr. 12pt Sockets:  
3/8", 7/16", 1/2", 9/16", 5/8", 11/16", 3/4", 13/16"
- 10 - 3/8" Dr. 12pt Sockets:  
10, 11, 12, 13, 14, 15, 16, 17, 18, 19mm
- 1 - 3/8" Dr. Quick Release Ratchet (T29837)
- 1 - 3/8" Dr. Universal Joint
- 1 - 3/8" Dr. Extension Bar: 3" (75mm)
- 1 - 1/4" Dr. Spinner Handle
- 1 - 1/4" Dr. x 1/4" Bit Holder
- 12 - 1/4" Screwdriver Bits (25mm)
  - 3 - Phillips: #1, #2, #3
  - 3 - Slotted: 3/16", 1/4", 9/32"
  - 3 - Star: T10, T15, T20
  - 3 - Robertson: R1, R2, R3
- 2 - Bit Holders

### Blowcase

#### T45660

### 96pc 1/4" & 3/8" Dr. Socket Set (SAE & Metric)

### Contents:

- 11 - 1/4" Dr. 6pt Sockets:  
5/32", 3/16", 7/32", 1/4", 9/32", 5/16", 11/32", 3/8", 7/16", 1/2", 9/16"
- 12 - 1/4" Dr. 6pt Sockets:  
4.5, 5, 5.5, 6, 7, 8, 9, 10, 11, 12, 13, 14mm
- 5 - 1/4" Dr. 6pt Deep Sockets:  
1/4", 9/32", 5/16", 3/8", 7/16"
- 5 - 1/4" Dr. 6pt Deep Sockets:  
7, 8, 9, 10, 11mm
- 10 - 3/8" Dr. 12pt Sockets:  
1/4", 3/8", 7/16", 1/2", 9/16", 5/8", 11/16", 3/4", 13/16", 7/8"
- 11 - 3/8" Dr. 12pt Sockets:  
9, 10, 11, 12, 13, 14, 15, 16, 17, 18, 19mm
- 5 - 3/8" Dr. 12pt Deep Sockets: 3/8", 7/16", 1/2", 9/16", 5/8"
- 5 - 3/8" Dr. 12pt Deep Sockets: 10, 11, 12, 13, 14mm
- 2 - Quick Release Offset Ratchets: 1/4", 3/8" Dr.
- 1 - 3/8" Dr. Spark Plug Socket: 5/8" (16mm)
- 1 - 1/4" Dr. Extension Bar: 3" (75mm)
- 1 - 3/8" Dr. Extension Bar: 6" (150mm)
- 1 - 3/8" (F) x 1/4" (M) Socket Adaptor
- 1 - 1/4" Bit Driver
- 24 - 1/4" Screwdriver Bits (25mm):
  - 4 - Phillips: #0, #1, #2, #3
  - 5 - Slotted: 5/32", 3/16", 7/32", 1/4", 9/32"
  - 5 - Hex: 1/8", 5/32", 3/16", 7/32", 1/4"
  - 5 - Star: T10, T15, T20, T25, T30
  - 4 - Square Recess: R0, R1, R2, R3
  - 1 - 1/4" Dr. Bit Adaptor
- 1 - Blowcase

#### T45672

### 65pc 1/4", 3/8" & 1/2" Dr. Socket Set (SAE & Metric)

### Contents: (Chrome Vanadium Steel)

- 10 - 1/4" Dr. 6pt Sockets:  
5/32", 3/16", 7/32", 1/4", 9/32", 5/16", 11/32", 3/8", 7/16", 1/2"
- 3 - 1/4" Dr. 8pt Sockets: 1/4", 5/16", 3/8"
- 12 - 1/4" Dr. 6pt Sockets:  
4, 4.5, 5, 5.5, 6, 7, 8, 9, 10, 11, 12, 13mm
- 8 - 3/8" Dr. 12pt Sockets:  
3/8", 7/16", 1/2", 9/16", 5/8", 11/16", 3/4", 13/16"
- 9 - 3/8" Dr. 12pt Sockets:  
10, 11, 12, 13, 14, 15, 17, 18, 19mm
- 6 - 1/2" Dr. 6pt Sockets: 1/2", 9/16", 5/8", 3/4", 13/16", 7/8"
- 4 - 1/4" Dr. 6pt Deep Sockets: 1/4", 9/32", 5/16", 11/32"
- 4 - 3/8" Dr. 12pt Deep Sockets: 3/8", 7/16", 1/2", 9/16"
- 1 - 3/8" Dr. Quick Release Offset Ratchet
- 1 - 1/2" Dr. Quick Release Offset Ratchet
- 1 - 3/8" Dr. Universal Joint
- 1 - 3/8" Dr. Spark Plug Socket: 5/8" (16mm)
- 1 - 1/4" Dr. Extension Bar: 3" (75mm)
- 1 - 3/8" Dr. Extension Bar: 3" (75mm)
- 1 - 1/4" Dr. Spinner Handle
- 1 - 3/8" (F) x 1/4" (M) Socket Adaptor
- 1 - 1/2" (F) x 3/8" (M) Socket Adaptor

### Blowcase

#### T45680

### 136pc 1/4", 3/8" & 1/2" Dr. Socket & Wrench Set (SAE & Metric)

### Contents: (Chrome Vanadium Steel)

- 10 - 1/4" Dr. 6pt Sockets:  
5/32", 3/16", 7/32", 1/4", 9/32", 5/16", 11/32", 3/8", 7/16", 1/2"
- 10 - 1/4" Dr. 6pt Sockets:  
4, 5, 6, 7, 8, 9, 10, 11, 12, 13mm
- 9 - 3/8" Dr. 12pt Sockets:  
3/8", 7/16", 1/2", 9/16", 5/8", 11/16", 3/4", 13/16", 7/8"

- 11 - 3/8" Dr. 12pt Sockets:
  - 9, 10, 11, 12, 13, 14, 15, 16, 17, 18, 19mm
- 4 - 1/2" Dr. 6pt Sockets: 15/16", 1", 1-1/16", 1-1/4"
- 7 - 1/2" Dr. 6pt Sockets: 20, 21, 22, 24, 27, 30, 32mm
- 4 - 1/4" Dr. 6pt Deep Sockets: 8, 9, 10, 12mm
- 4 - 3/8" Dr. 12pt Deep Sockets: 13, 14, 15, 17mm
- 4 - 1/2" Dr. 6pt Impact Sockets: 17, 19, 21, 23mm
- 8 - 3/8" Dr. E Sockets:
  - E8, E10, E11, E12, E14, E16, E18, E20
- 3 - Quick Release Offset Ratchets: 1/4", 3/8", 1/2" Dr.
- 3 - Universal Joints 1/4", 3/8" & 1/2" Dr.
- 2 - 3/8" Dr. Spark Plug Sockets: 16, 21mm
- 1 - 1/4" Dr. Extension: 2" (50mm)
- 2 - 3/8" Dr. Extension Bars: 3", 6" (75, 150mm)
- 2 - 1/2" Dr. Extension Bars: 5", 10" (125, 250mm)
- 2 - Sliding T-Adaptors: 3/8" (F) x 1/4" (M), 1/2" (F) x 3/8" (M)
- 9 - Combination Wrenches:
  - 8, 10, 12, 13, 14, 16, 17, 18, 19mm
- 1 - 1/4" Dr. Spinner Handle
- 3 - Bit Adaptors:
  - 1/4" Dr. x 1/4", 3/8" Dr. x 5/16", 1/2" Dr. x 10mm
- 18 - 1/4" Screwdriver Bits (25mm)
  - 2 - Phillips: #1, #2
  - 3 - Slotted: 4, 5.5, 6.5mm
  - 4 - Hex: 3, 4, 5, 6mm
  - 2 - Pozi: #1, #2
  - 7 - Tampered Star: T10, T15, T20, T25, T27, T30, T40
- 15 - 5/16" Screwdriver Bits (30mm)
  - 2 - Phillips: #3, #4
  - 3 - Slotted: 8, 10, 12mm
  - 4 - Hex: 8, 10, 12, 14mm
  - 2 - Pozi: #3, #4
  - 4 - Tampered Star: T45, T50, T55, T60
- 4 - 3/8" (10mm) Spline Bits: M6, M8, M10, M12 (75mm)

Blowcase

### T45681

#### 122pc 1/4", 3/8" 1/2" Dr. Socket & Wrench Set (SAE & Metric)

Contents:

- 9 - 1/4" Dr. 6pt Sockets:
  - 7/32", 1/4", 9/32", 5/16", 11/32", 3/8", 7/16", 1/2", 9/16"
- 10 - 1/4" Dr. 6pt Sockets:
  - 5.5, 6, 7, 8, 9, 10, 11, 12, 13, 14mm
- 7 - 3/8" Dr. 6pt Sockets:
  - 3/8", 7/16", 1/2", 9/16", 5/8", 11/16", 3/4"
- 8 - 3/8" Dr. 6pt Sockets:
  - 10, 12, 13, 14, 15, 16, 17, 18mm
- 8 - 3/8" Dr. 12pt Sockets:
  - 1/4", 3/8", 7/16", 1/2", 9/16", 5/8", 11/16", 3/4"
- 11 - 3/8" Dr. 12pt Sockets:
  - 9, 10, 11, 12, 13, 14, 15, 16, 17, 18, 19mm
- 4 - 1/2" Dr. 12pt Sockets: 3/4", 13/16", 7/8", 15/16"
- 4 - 1/2" Dr. 12pt Sockets: 17, 18, 19, 21mm
- 5 - 1/4" Dr. 6pt Deep Sockets:
  - 1/4", 9/32", 5/16", 3/8", 7/16"
- 5 - 1/4" Dr. 6pt Deep Sockets: 7, 8, 9, 10, 11mm
- 5 - 3/8" Dr. 12pt Deep Sockets: 3/8", 7/16", 1/2", 9/16", 5/8"
- 5 - 3/8" Dr. 12pt Deep Sockets: 10, 11, 12, 13, 14mm
- 3 - Quick Release Offset Ratchets: 1/4", 3/8", 1/2" Dr.
- 1 - Spark Plug Socket: 3/8" Dr. x 5/8"
- 2 - Extension Bars: 1/4" Dr. x 3", 3/8" Dr. x 6"
- 2 - Open End Wrenches: 3/8" x 7/16", 1/2" x 9/16"
- 2 - Open End Wrenches: 10 x 11mm, 12 x 14mm
- 11 - Hex Key Wrenches:
  - 0.05, 1/16", 5/64", 3/32", 7/64", 1/8", 9/64", 5/32", 3/16", 7/32", 1/4"
- 6 - Nut Driver Bits: 3/16", 1/4", 5/16", 11/32", 3/8", 7/16"
- 6 - Nut Driver Bits: 6, 7, 8, 9, 10, 11mm
- 1 - 1/4" Dr. Bit Driver
- 7 - 1/4" Screwdriver Bits
  - 3 - Slotted: 6, 8, 10mm
  - 3 - Phillips: #1, #2, #3

1 - 1/4" Bit Adaptor

Blowcase

### T45684

#### 151pc 1/4", 3/8" 1/2" Dr. Socket & Wrench Set (SAE & Metric)

Contents:

- 9 - 1/4" Dr. 6pt Sockets:
  - 7/32", 1/4", 9/32", 5/16", 11/32", 3/8", 7/16", 1/2", 9/16"
- 10 - 1/4" Dr. 6pt Sockets:
  - 5.5, 6, 7, 8, 9, 10, 11, 12, 13, 14mm
- 7 - 3/8" Dr. 6pt Sockets:
  - 3/8", 7/16", 1/2", 9/16", 5/8", 11/16", 3/4"
- 8 - 3/8" Dr. 6pt Sockets:
  - 10, 12, 13, 14, 15, 16, 17, 18mm
- 8 - 3/8" Dr. 12pt Sockets:
  - 1/4", 3/8", 7/16", 1/2", 9/16", 5/8", 11/16", 3/4"
- 11 - 3/8" Dr. 12pt Sockets:
  - 9, 10, 11, 12, 13, 14, 15, 16, 17, 18, 19mm
- 7 - 1/2" Dr. 12pt Sockets:
  - 3/4", 13/16", 7/8", 15/16", 1", 1-1/16", 1-1/8"
- 8 - 1/2" Dr. 12pt Sockets:
  - 17, 18, 19, 20, 21, 22, 23, 24mm
- 5 - 1/4" Dr. 6pt Deep Sockets:
  - 1/4", 9/32", 5/16", 3/8", 7/16"
- 5 - 1/4" Dr. 6pt Deep Sockets:
  - 7, 8, 9, 10, 11mm
- 5 - 3/8" Dr. 12pt Deep Sockets:
  - 3/8", 7/16", 1/2", 9/16", 5/8"
- 5 - 3/8" Dr. 12pt Deep Sockets:
  - 10, 11, 12, 13, 14mm
- 3 - Quick Release Offset Ratchets: 1/4", 3/8", 1/2" Dr.
- 1 - Spark Plug Socket: 3/8" Dr. x 5/8"
- 2 - Extension Bars: 1/4" Dr. x 3", 3/8" Dr. x 6"
- 6 - Combination Wrenches: 3/8", 7/16", 1/2", 9/16", 5/8", 3/4"
- 6 - Combination Wrenches: 10, 12, 13, 14, 15, 16mm
- 11 - Hex Key Wrenches:
  - 0.05, 1/16", 5/64", 3/32", 7/64", 1/8", 9/64", 5/32", 3/16", 7/32", 1/4"
- 11 - Hex Key Wrenches:
  - 1.27, 1.5, 2, 2.5, 3, 3.5, 4, 4.5, 5, 5.5, 6mm
- 6 - Nut Driver Bits (SAE): 3/16", 1/4", 5/16", 11/32", 3/8", 7/16"
- 6 - Nut Driver Bits (Metric): 6, 7, 8, 9, 10, 11mm
- 1 - 1/4" Dr. Bit Driver
- 10 - 1/4" Screwdriver Bits
  - 3 - Slotted: 6, 8, 10mm
  - 3 - Phillips: #1, #2, #3
  - 2 - Star: T15, T20
  - 1 - Square Recess: #2
  - 1 - 1/4" Bit Adaptor

Blowcase

### T45690

#### 170pc 1/4", 3/8" & 1/2" Dr. Socket & Wrench Set (SAE & Metric)

Contents:

- 11 - 1/4" Dr. 6pt Sockets:
  - 5/32", 3/16", 7/32", 1/4", 9/32", 5/16", 11/32", 3/8", 7/16", 1/2", 9/16"
- 12 - 1/4" Dr. 6pt Sockets:
  - 4.5, 5, 5.5, 6, 7, 8, 9, 10, 11, 12, 13, 14mm
- 7 - 3/8" Dr. 6pt Sockets:
  - 3/8", 7/16", 1/2", 9/16", 5/8", 11/16", 3/4"
- 8 - 3/8" Dr. 6pt Sockets:
  - 10, 12, 13, 14, 15, 16, 17, 18mm
- 10 - 3/8" Dr. 12pt Sockets:
  - 1/4", 3/8", 7/16", 1/2", 9/16", 5/8", 11/16", 3/4", 13/16", 7/8"
- 12 - 3/8" Dr. 12pt Sockets:
  - 8, 9, 10, 11, 12, 13, 14, 15, 16, 17, 18, 19mm
- 8 - 1/2" Dr. 12pt Sockets:
  - 11/16", 3/4", 13/16", 7/8", 15/16", 1", 1-1/16", 1-1/8"
- 8 - 1/2" Dr. 12pt Sockets:
  - 17, 18, 19, 20, 21, 22, 23, 24mm





- 7 - 1/4" Dr. 6pt Deep Sockets:  
1/4", 9/32", 5/16", 11/32", 3/8", 7/16", 1/2"
- 7 - 1/4" Dr. 6pt Deep Sockets: 6, 7, 8, 9, 10, 11, 12mm
- 7 - 3/8" Dr. 12pt Deep Sockets:  
3/8", 7/16", 1/2", 9/16", 5/8", 11/16", 3/4"
- 7 - 3/8" Dr. 12pt Deep Sockets:  
10, 11, 12, 13, 14, 15, 16mm
- 3 - Quick Release Offset Ratchet: 1/4", 3/8" & 1/2" Dr.
- 1 - 3/8" Dr. Spark Plug Socket: 5/8" (16mm)
- 1 - 1/4" Dr. Extension Bar: 3" (75mm)
- 2 - 3/8" Dr. Extension Bars: 3", 6" (75, 150mm)
- 6 - Combination Wrenches: 3/8", 7/16", 1/2", 9/16", 5/8", 3/4"
- 6 - Combination Wrenches: 10, 12, 13, 14, 15, 16mm
- 11 - Hex Key Wrenches:  
0.05", 1/16", 5/64", 3/32", 7/64", 1/8", 9/64", 5/32", 3/16", 7/32", 1/4"
- 11 - Hex Key Wrench:  
1.27, 1.5, 2, 2.5, 3, 3.5, 4, 4.5, 5, 5.5, 6mm
- 1 - 1/4" Dr. Bit Driver
- 1 - 1/4" Dr. Bit Coupler
- 23 - 1/4" Screwdriver Bits (25mm)  
3 - Phillips: #1, #2, #3  
6 - Slotted: 5/32", 3/16", 7/32", 1/4", 9/32", 5/16"  
4 - Hex: 5/32", 3/16", 7/32", 1/4"  
3 - Pozzi: #1, #2, #3  
6 - Star: T15, T20, T25, T27, T30, T40  
1 - 1/4" Dr. Bit Adaptor

### T45700

#### 14pc 3/4" Dr. Socket Set (6pt) (Metric)

Contents: (Chrome Vanadium Steel)

- 10 - 3/4" Dr. 6pt Sockets:  
22, 24, 27, 30, 32, 36, 38, 41, 46, 50mm
- 1 - 3/4" Dr. Reversible Ratchet
- 2 - 3/4" Dr. Extension Bars: 4", 8" (100, 200mm)
- 1 - 3/4" Dr. Sliding T-Handle

Metal Case

### T45701

#### 20pc 3/4" Dr. Socket Set (6pt) (Metric)

Contents: (Chrome Vanadium Steel)

- 16 - 3/4" Dr. 6pt Sockets:  
19, 21, 22, 23, 24, 26, 27, 29, 30, 32, 35, 36, 38, 41, 46, 50mm
- 1 - 3/4" Dr. Reversible Ratchet
- 2 - 3/4" Dr. Extension Bars: 4", 8" (100, 200mm)
- 1 - 3/4" Dr. Sliding T-Handle

Metal Case

### T45720

#### 14pc 3/4" Dr. Socket Set (12pt) (Metric)

Contents: (Chrome Vanadium Steel)

- 10 - 3/4" Dr. 12pt Sockets:  
22, 24, 27, 30, 32, 36, 38, 41, 46, 50mm
- 1 - 3/4" Dr. Reversible Ratchet
- 2 - 3/4" Dr. Extension Bars: 4", 8" (100, 200mm)
- 1 - 3/4" Dr. Sliding T-Handle

Metal Case

### T45721

#### 20pc 3/4" Dr. Socket Set (12pt) (Metric)

Contents: (Chrome Vanadium Steel)

- 16 - 3/4" Dr. 12pt Sockets:  
19, 21, 22, 23, 24, 26, 27, 29, 30, 32, 35, 36, 38, 41, 46, 50mm
- 1 - 3/4" Dr. Reversible Ratchet
- 2 - 3/4" Dr. Extension Bars: 4", 8" (100, 200mm)
- 1 - 3/4" Dr. Sliding T-Handle

Metal Case

### T45740

#### 14pc 3/4" Dr. Socket Set (12pt) (SAE)

Contents: (Chrome Vanadium Steel)

- 10 - 3/4" Dr. 12pt Sockets:  
7/8", 15/16", 1", 1-1/16", 1-1/4", 1-7/16", 1-1/2", 1-5/8", 1-3/4", 2"
- 1 - 3/4" Dr. Reversible Ratchet
- 2 - 3/4" Dr. Extension Bars: 4", 8" (100, 200mm)
- 1 - 3/4" Dr. Sliding T-Handle

Metal Case

### T45741

#### 20pc 3/4" Dr. 12pt Socket Set (SAE)

Contents: (Chrome Vanadium Steel)

- 16 - 3/4" Dr. 12pt Sockets:  
7/8", 15/16", 1", 1-1/16", 1-1/8", 1-3/16", 1-1/4", 1-5/16", 1-3/8",  
1-7/16", 1-1/2", 1-5/8", 1-3/4", 1-13/16", 1-7/8", 2"
- 1 - 3/4" Dr. Reversible Ratchet
- 2 - 3/4" Dr. Extension Bars: 4", 8" (100, 200mm)
- 1 - 3/4" Dr. Sliding T-Handle

Metal Case

### T45760

#### 14pc 1" Dr. Socket Set (12pt) (Metric)

Contents: (Chrome Vanadium Steel)

- 10 - 1" Dr. Sockets:  
36, 41, 46, 50, 55, 60, 65, 70, 75, 80mm
- 1 - 1" Dr. Reversible Ratchet
- 2 - 1" Dr. Extension Bars: 8", 16" (200, 400mm)
- 1 - 1" Dr. Sliding T-Adaptor

Metal Case

### T45761

#### 21pc 1" Dr. Socket Set (12pt) (Metric)

Contents: (Chrome Vanadium Steel)

- 17 - 1" Dr. Sockets:  
36, 38, 41, 46, 50, 54, 55, 58, 60, 63, 65, 67, 70, 71, 75, 77, 80mm
- 1 - 1" Dr. Reversible Ratchet
- 2 - 1" Dr. Extension Bars: 8", 16" (200, 400mm)
- 1 - 1" Dr. Sliding T-Adaptor

Metal Case

### T45762

#### 14pc 1" Dr. 6pt Socket Set (Metric)

Contents: (Chrome Vanadium Steel)

- 10 - 1" Dr. Sockets:  
36, 41, 46, 50, 55, 60, 65, 70, 75, 80mm
- 1 - 1" Dr. Reversible Ratchet
- 1 - 1" Dr. Sliding T-Adaptor
- 2 - 1" Dr. Extension Bars: 8", 16" (200, 400mm)

Metal Case

### T45780

#### 14pc 1" Dr. Socket Set (12pt) (SAE)

Contents: (Chrome Vanadium Steel)

- 10 - 1" Dr. 12pt Sockets:  
1-7/16", 1-1/2", 1-11/16", 1-7/8", 2", 2-1/4", 2-3/8", 2-5/8",  
2-15/16", 3-1/8"
- 1 - 1" Dr. Reversible Ratchet
- 1 - 1" Dr. Sliding T-Adaptor
- 2 - 1" Dr. Extension Bars: 8", 16" (200, 400mm)

Metal Case

### T45781

#### 21pc 1" Dr. Socket Set (12pt) (SAE)

Contents: (Chrome Vanadium Steel)

- 17 - 1" Dr. 12pt Sockets:  
1-7/16", 1-1/2", 1-5/8", 1-11/16", 1-3/4", 1-13/16", 1-7/8", 2",  
2-1/8", 2-3/16", 2-1/4", 2-3/8", 2-1/2", 2-5/8", 2-3/4", 2-15/16",  
3-1/8"
- 1 - 1" Dr. Reversible Ratchet
- 2 - 1" Dr. Extension Bars: 8", 16" (200, 400mm)
- 1 - 1" Dr. Sliding T-Adaptor

Metal Case

**T45785**
**15pc 1" Dr. Socket Set (6pt) (Metric)**

Contents:

- 11 - 1" Dr. 6pt Sockets:
  - 36, 38, 41, 46, 50, 55, 60, 65, 70, 75, 80mm
- 1 - Ratchet Handle with Quick Release: 500-800mm
- 2 - Extension Bars with Quick Release: 8" & 16"
- 1 - Sliding T-Handle with Quick Release: 22"

Metal Case

**T45809**
**37pc 1/4" Dr. Fits-All Go-Thru Socket Set**

Contents:

- 10 - 13mm Fits-All Go-Thru Sockets:
  - 4.5, 5, 5.5, 6, 7, 8, 9, 10, 11, 12mm
- 1 - 13mm Go-Thru Reversible Offset Ratchet
- 1 - 1/4" Dr. Ratchet & 1/4" Bit Adaptor
- 1 - 13mm Go-Thru Deep Socket Adaptor
- 24 - 1/4" Screwdriver Bits (25mm):
  - 4 - Phillips: #0, #1, #2, #3
  - 5 - Slotted: 2.5, 3, 4, 5, 7mm
  - 5 - Hex: 2, 3, 4, 5, 6mm
  - 6 - Star: T10, T15, T20, T25, T27, T30
  - 4 - Pozzi: #0, #1, #2, #3

Blowcase

**T45821**
**60pc 1/4" & 3/8" Dr. Fits-All Go-Thru Socket Set**

Contents:

- 12 - 13mm Fits-All Go-Thru Sockets:
  - 4.5, 5, 5.5, 6, 6.5, 7, 8, 9, 10, 11, 12, 13mm
- 10 - 19mm Fits-All Go-Thru Sockets:
  - 10, 11, 12, 13, 14, 15, 16, 17, 18, 19mm
- 2 - Go-Thru Reversible Ratchets: 13, 19mm
- 2 - Universal Joints: 1/4", 3/8" Dr.
- 2 - 3/8" Dr. Spark Plug Sockets: 16mm, 21mm
- 2 - Extension Bars:
  - 1/4" Dr. x 4" (100mm), 3/8" Dr. x 3" (75mm)
- 2 - Go-Thru Socket Adaptors:
  - 1/4" Dr. x 13mm, 3/8" Dr. x 19mm
- 2 - Go-Thru Deep Socket Adaptors: 13, 19mm  
(Converts Standard Sockets to Deep Sockets)
- 2 - Quick Release Ratchet Adaptors:
  - 1/4" Dr. x 13mm, 3/8" Dr. x 19mm
- 1 - Stubby Geared Bit Driver w/ Bit Storage
- 1 - 1/4" Bit Coupler
- 22 - 1/4" Screwdriver Bits:
  - 3 - Phillips: #1, #2, #3
  - 5 - Slotted: 2.5, 3, 4, 5, 7
  - 3 - Pozzi: #1, #2, #3
  - 6 - Star: T10, T15, T20, T25, T27, T30
  - 5 - Hex: 2, 3, 4, 5, 6mm

Blowcase

**T45822**
**33pc 1/4" & 3/8" Dr. Fits-All Go-Thru Socket Set**

Contents:

- 12 - 13mm Fits-All Go-Thru Sockets:
  - 4.5, 5, 5.5, 6, 6.5, 7, 8, 9, 10, 11, 12, 13mm
- 10 - 19mm Fits-All Go-Thru Sockets:
  - 10, 11, 12, 13, 14, 15, 16, 17, 18, 19mm
- 2 - Go-Thru Reversible Ratchets: 13, 19mm
- 1 - 3/8" Dr. Universal Joint
- 2 - Extension Bars: 1/4" Dr. x 4", 3/8" Dr. x 3"
- 2 - Go-Thru Socket Adaptors: 1/4", 3/8" Dr.  
(Allows Standard Ratchets to work w/ Go-Thru Sockets)
- 1 - 1/4" Dr. Ratchet & Bit Adaptor
- 1 - 3/8" Dr. x 19mm Quick Release Ratchet Adaptors  
(Converts Go-Thru Ratchet to Traditional Ratchets)
- 2 - Go-Thru Hex Extension Adaptors: 13, 19mm

(Converts Standard Sockets to Deep Socket)

**T45823**
**23pc 3/8" & 1/2" Dr. Fits-All Go-Thru Socket Set**

Contents:

- 9 - 19mm Fits-All Go-Thru Sockets:
  - 10, 11, 12, 13, 14, 15, 16, 17, 18mm
- 7 - 22mm Fits-All Go-Thru Sockets:
  - 19, 21, 22, 24, 27, 30, 32mm
 (22mm x 19mm Go-Thru Socket can be used as an adaptor for 19mm Go-Thru Sockets)
- 1 - 22mm Go-Thru Reversible Offset Ratchet
- 1 - 1/2" Dr. Universal Joint
- 2 - 1/2" Dr. Spark Plug Sockets: 16, 21mm
- 1 - 1/2" Dr. x 125mm Extension Bar
- 1 - 22mm Go-Thru Deep Socket Adaptor
- 1 - 1/2" Dr. x 22mm Quick Release Ratchet Adaptor

Blowcase

**T45825**
**80pc 1/4" & 3/8" Dr. Fits-All Go-Thru Socket and Tool Set**

Contents:

- 12 - 13mm Fits-All Go-Thru Sockets:
  - 4.5, 5, 5.5, 6, 6.5, 7, 8, 9, 10, 11, 12, 13mm
- 10 - 19mm Fits-All Go-Thru Sockets:
  - 10, 11, 12, 13, 14, 15, 16, 17, 18, 19mm
- 2 - Go-Thru Reversible Ratchets: 13, 19mm
- 2 - Universal Joints: 1/4" & 3/8" Dr.
- 2 - 3/8" Dr. Spark Plug Sockets: 5/8", 13/16" (16, 21mm)
- 2 - Extension Bars: 1/4" x 4" (100mm), 3/8" x 3" (75mm)
- 2 - Go-Thru Socket Adaptors:
  - 1/4" Dr. x 13mm, 3/8" Dr. x 19mm
- 2 - Go-Thru Extension Adaptors: 13, 19mm
- 2 - Quick Release Ratchet Adaptors:
  - 1/4" Dr. x 13mm, 3/8" Dr. x 19mm
- 1 - 1/4" Dr. Bit Coupler
- 1 - Stubby Geared Bit Driver
- 22 - 1/4" Screwdriver Bits:
  - 3 - Phillips: #1, #2, #3
  - 5 - Slotted: 2.5, 3, 4, 5, 7
  - 3 - Pozzi: #1, #2, #3
  - 6 - Star: T10, T15, T20, T25, T27, T30
  - 5 - Hex: 2, 3, 4, 5, 6mm
- 1 - 150mm Long Nose Pliers
- 1 - 150mm Linesman Pliers
- 1 - Utility Knife
- 6 - Fits-All Combination Wrenches:
  - 8, 10, 12, 13, 14, 17mm
- 11 - Hex Key Wrenches:
  - 1.27, 1.5, 2, 2.5, 3, 3.5, 4, 4.5, 5, 5.5, 6mm

Blowcase

**T45831**
**50pc 1/4", 3/8" & 1/2" Dr. Fits-All Go-Thru Socket Set**

Contents:

- 12 - 13mm Fits-All Go-Thru Sockets:
  - 4.5, 5, 5.5, 6, 6.5, 7, 8, 9, 10, 11, 12, 13mm
- 10 - 19mm Fits-All Go-Thru Sockets:
  - 10, 11, 12, 13, 14, 15, 16, 17, 18, 19mm
- 8 - 22mm Fits-All Go-Thru Sockets:
  - 20, 21, 22, 23, 24, 27, 30, 32mm
- 3 - Go-Thru Geared Reversible Ratchets: 13, 19, 22mm
- 3 - Universal Joints: 1/4", 3/8", 1/2" Dr.
- 2 - 3/8" Dr. Spark Plug Sockets: 16, 21mm
- 3 - Extension Bars:
  - 1/4" Dr. x 100mm, 3/8" Dr. x 75mm, 1/2" Dr. x 125mm
- 3 - Go-Thru Deep Socket Adaptors: 13, 19, 22mm  
(Converts Standard Sockets to Deep Sockets)
- 3 - Go-Thru Socket Adaptors:
  - 1/4" Dr. x 13mm, 3/8" Dr. x 19mm, 1/2" Dr. x 22mm



(Allows Standard Ratchets to work with Go-Thru Sockets)

- 2 - Quick Release Ratchet Adaptors:
  - 3/8" Dr. x 19mm, 1/2" Dr. x 22mm
 (Converts Go-Thru Ratchets to Standard Ratchets)
  - 1 - 1/4" Dr. Ratchet & Bit Adaptor

Blowcase

### T45836

#### 97pc 1/4", 3/8" & 1/2" Dr. Fits-All Go-Thru Socket and Tool Set

Contents:

- 12 - 13mm Fits-All Go-Thru Sockets:
  - 4.5, 5, 5.5, 6, 6.5, 7, 8, 9, 10, 11, 12, 13mm
- 10 - 19mm Fits-All Go-Thru Sockets:
  - 10, 11, 12, 13, 14, 15, 16, 17, 18, 19mm
- 5 - 22mm Fits-All Go-Thru Sockets:
  - 20, 21, 22, 23, 24mm
- 3 - 22mm 1/2" Dr. 6pt Sockets: 27, 30, 32mm
- 3 - Go-Thru Reversible Ratchets: 13, 19, 22mm
- 3 - Go-Thru Socket Adaptors:
  - 1/4" Dr. x 13mm, 3/8" Dr. x 19mm, 1/2" Dr. x 22mm
- 3 - Fits-All Go-Thru Deep Socket Adaptors: 13, 19, 22mm
- 3 - Quick Release Ratchet Adaptors:
  - 1/4" Dr. x 13mm, 3/8" Dr. x 19mm, 1/2" Dr. x 22mm
- 1 - 150mm Long Nose Pliers
- 1 - 150mm Diagonal Cutting Pliers
- 1 - 175mm Combination Pliers
- 1 - 200mm Adjustable Wrench
- 1 - Retractable Utility Knife w/ Blade
- 5 - 12pt Fits-All Combination Wrenches:
  - 10, 12, 13, 14, 17mm
- 11 - Hex Key Wrenches:
  - 1.27, 1.5, 2, 2.5, 3, 3.5, 4, 4.5, 5, 5.5, 6mm
- 1 - Bit Driver with Cushion Grip
- 1 - 1/4" Bit Coupler
- 24 - 1/4" Screwdriver Bits:
  - 4 - Phillips: #0, #1, #2, #3
  - 5 - Slotted: 2.5, 3, 4, 5, 7
  - 4 - Pozi: #0, #1, #2, #3
  - 6 - Star: T10, T15, T20, T25, T27, T30
  - 5 - Hex: 2, 3, 4, 5, 6mm
- 3 - Extension Bars:
  - 1/4" Dr. x 4" (100mm), 3/8" Dr. x 3" (75mm), 1/2" Dr. x 5" (125mm)
- 3 - Universal Joints: 1/4", 3/8", 1/2" Dr.
- 2 - 3/8" Dr. Spark Plug Sockets: 16mm, 21mm

Blowcase

### T45847

#### 22pc 1/2" Dr. Fits-All Socket Set

Contents:

- 18 - 1/2" Dr. Fits-All Sockets:
  - 10, 11, 12, 13, 14, 15, 16, 17, 18, 19, 20, 21, 22, 23, 24, 27, 30, 32mm
- 1 - 1/2" Dr. Quick Release Offset Ratchet
- 1 - 1/2" Dr. Universal Joint
- 2 - 1/2" Dr. Extension Bars: 125, 250mm

### T45900

#### 71 pc Tool Set w/ Aluminum Trolley Case (Metric)

Contents:

- 9 - Combination Wrenches:
  - 8, 9, 10, 11, 12, 13, 14, 17, 19mm
- 1 - 5m x 19mm Auto-Lock Tape Measures w/ Steel Case
- 1 - 8" (200mm) Adjustable Wrench
- 1 - Utility Knife
- 10 - Utility Knife Replacement Blades
- 1 - Mini Hack Saw (Bow Style)
- 1 - 10" (250mm) Box Joint Water Pump Pliers
- 1 - 6" (150mm) Long Nose Pliers
- 1 - 6" (150mm) Diagonal Cutting Pliers
- 1 - 7" (180mm) Combination Pliers

7 - Screwdrivers:

- 4 - Slotted: 6 x 38, 6 x 100, 6 x 150, 8mm x 150mm
  - 3 - Phillips: #1 x 75, #2 x 38, #2 x 100mm
  - 5 - Star Screwdrivers: T10, T15, T20, T25, T30
  - 5 - Precision Screwdrivers:
    - 3 - Slotted: 2 x 75, 2.5 x 75, 3mm x 75mm
    - 2 - Phillips: #0 x 75, #00 x 75mm
  - 1 - 300G Engineer's Hammer
  - 1 - 8" (200mm) Mill File
  - 1 - 8" (200mm) Three-Square File
  - 1 - 8" (200mm) Round File
  - 3 - Mini Files: Three-Square, Mill, Round
  - 1 - PTFE Seal Tape: 12mm x 0.095mm x 10m
  - 1 - Electrical Tape: 3/4" (19mm)
  - 1 - 6-380V Tester
  - 9 - Hex Wrenches: 1.5, 2, 2.5, 3, 4, 5, 6, 8, 10mm
  - 1 - Solder Wire Dispenser Tubes
  - 2 - Glue Sticks 7.5 x 100mm
  - 1 - Solder Sucker
  - 1 - 8" (200mm) Wire Stripper
  - 1 - 40W Electric Soldering Iron
  - 1 - 10W Glue Gun
  - 1 - 5" (125mm) Electrical Pliers
- Aluminum Case w/ Tray

### T45901

#### 136 pc Tool Set w/ Aluminum Trolley Case (SAE & Metric)

Contents:

- 19 - 1/4" Dr. 6pt Sockets (SAE & Metric):
  - 4, 4.5, 5, 6, 7, 8, 9, 10, 11, 12mm
  - 3/16", 7/32", 1/4", 9/32", 5/16", 11/32", 3/8", 7/16", 1/2"
- 5 - 1/4" Dr. 6pt Deep Sockets:
  - 6, 7, 8, 9, 10mm
- 15 - 3/8" Dr. 6pt Sockets (SAE & Metric):
  - 10, 11, 12, 13, 14, 16, 17, 19mm
  - 3/8", 7/16", 1/2", 9/16", 5/8", 11/16", 3/4"
- 5 - 3/8" Dr. 6pt Deep Socket (Metric):
  - 12, 13, 14, 15, 17mm
- 1 - 1/4" Dr. Quick-Release Offset Ratchet
- 1 - 3/8" Dr. Quick-Release Offset Ratchet
- 2 - Universal Joints: 1/4", 3/8" Dr.
- 2 - 3/8" Dr. Spark Plug Sockets: 16, 21mm
- 1 - 3/8" Dr. (F) x 1/4" (M) Adaptor
- 2 - 1/4" Dr. Extension Bars: 75, 150mm
- 2 - 3/8" Dr. Extension Bars: 75, 150mm
- 1 - 1/4" Dr. Spinner Handle
- 1 - 1/4" Bit Coupler
- 24 - 1/4" Screwdriver Bits (25mm):
  - 4 - Phillips: #0, #1, #2, #3
  - 4 - Slotted: 4, 4.5, 5.5, 6mm
  - 5 - Hex: 3, 4, 5, 6, 7mm
  - 7 - Star: T10, T15, T20, T25, T27, T30, T40
  - 4 - Pozi: #0, #1, #2, #3
- 9 - Combination Wrenches:
  - 8, 10, 12, 13, 14, 15, 17, 19, 22mm
- 1 - 5m x 19mm Auto-Lock Tape Measures w/ Steel Case
- 1 - 10" Locking Grip Pliers
- 1 - 10" Box Joint Water Pump Pliers
- 1 - 6" Diagonal Cutting Pliers
- 1 - 6" Long Nose Pliers
- 1 - 7" Combination Pliers
- 1 - 8" Round File
- 1 - 8" Mill File
- 1 - Mini Mill File
- 9 - Hex Key Set: 1.5, 2, 2.5, 3, 4, 5, 6, 8, 10mm
- 1 - Utility Knife
- 10 - Utility Knife Replacement Blades
- 8 - Screwdrivers:
  - 3 - Phillips: #1 x 75, #2 x 38, #2 x 100mm
  - 3 - Slotted: 6 x 38, 6 x 100, 8 x 150mm



- 2 - Pozi: #1 x 75, #2 x 100mm
  - 1 - 6-24V Tester (Brass)
  - 1 - 6-380V Tester
  - 1 - Center Punch: 4 x 120mm
  - 1 - Cold Chisel: 15 x 150mm
  - 1 - Pin Punch: 5 x 150mm
  - 1 - 300G Engineer Hammer
  - 1 - Rubber Hammer (PVC)
  - 1 - 8" Adjustable Wrench
  - 1 - Mini Brass Brush
- Aluminum Case

### T45902

#### 122pc Tool Set w/ Aluminum Trolley Case (Metric)

Contents:

- 13 - 1/4" Dr. 6pt Sockets:
    - 4, 4.5, 5, 5.5, 6, 7, 8, 9, 10, 11, 12, 13, 14mm
  - 18 - 1/2" Dr. 6pt Sockets:
    - 10, 11, 12, 13, 14, 15, 16, 17, 18, 19, 20, 21, 22, 23, 24, 27, 30, 32mm
  - 2 - Quick Release Offset Ratchets: 1/4", 1/2" Dr.
  - 2 - Universal Joints: 1/4", 1/2" Dr.
  - 2 - 1/2" Dr. Spark Plug Sockets: 16, 21mm
  - 2 - 1/4" Dr. Extension Bars: 2" (50mm), 4" (100mm)
  - 2 - 1/2" Dr. Extension Bars: 5" (125mm), 10" (250mm)
  - 1 - 1/4" Dr. Sliding T-Handle
  - 1 - 3/8" (F) x 1/2" (M) Sliding T - Adaptor
  - 9 - Combination Wrenches:
    - 8, 10, 12, 13, 14, 15, 17, 19, 22mm
  - 1 - 1/4" Bit Coupler
  - 1 - 1/4" Dr. Spinner Handle
  - 22 - 1/4" Screwdriver Bits (25mm):
    - 3 - Phillips: #1, #2, #3
    - 3 - Hex: 4, 5, 6mm
    - 3 - Pozi: #1, #2, #3
    - 6 - Slotted: 3, 4, 5, 5.5, 6, 7mm
    - 6 - Star: T15, T20, T25, T27, T30, T40
    - 1 - Bit Adaptor
  - 1 - 5m x 19mm Auto-Lock Tape Measures w/ Steel Case
  - 9 - Hex Keys: 1.5, 2, 2.5, 3, 4, 5, 6, 8, 10mm
  - 1 - Utility Knife
  - 10 - Utility Knife Replacement Blades
  - 1 - 10" (250mm) Lock Grip Pliers
  - 1 - 10" (250mm) Box Joint Water Pump Pliers
  - 1 - 6" (150mm) Long Nose Pliers
  - 1 - 6" (150mm) Diagonal Cutting Pliers
  - 1 - 7" (180mm) Combination Pliers
  - 1 - 8" (200mm) Round File
  - 1 - 8" (200mm) Mill File
  - 1 - Mini Mill File
  - 8 - Screwdrivers:
    - 3 - Slotted: 8 x 150, 6 x 100, 6 x 38mm
    - 3 - Phillips: #1 x 75, #2 x 100, #2 x 38mm
    - 2 - Pozi: #1 x 75, #2 x 100mm
  - 1 - 6-24V Tester (Brass)
  - 1 - 6-380V Tester
  - 1 - Center Punch: 4 x 120mm
  - 1 - Cold Chisel: 15 x 150mm
  - 1 - Pin Punch: 5 x 150mm
  - 1 - 300G Engineer Hammer
  - 1 - Rubber Hammer (PVC)
  - 1 - 8" (200mm) Adjustable Wrench
  - 1 - Mini Brass Brush
- Aluminum Case

### T45907

#### 81pc 1/4" & 3/8" Dr. Socket Set w/Aluminum Case (SAE & Metric)

Contents:

- 9 - 1/4" Dr. 6pt Sockets:

- 3/16", 7/32", 1/4", 9/32", 5/16", 11/32", 3/8", 7/16", 1/2"
  - 10 - 1/4" Dr. 6pt Sockets:
    - 4, 4.5, 5, 6, 7, 8, 9, 10, 11, 12mm
  - 7 - 3/8" Dr. 6pt Sockets:
    - 3/8", 7/16", 1/2", 9/16", 5/8", 11/16", 3/4"
  - 8 - 3/8" Dr. 6pt Sockets:
    - 10, 11, 12, 13, 14, 16, 17, 19mm
  - 5 - 1/4" Dr. 6pt Deep Sockets:
    - 6, 7, 8, 9, 10mm
  - 5 - 3/8" Dr. 6pt Deep Sockets:
    - 12, 13, 14, 15, 17mm
  - 2 - Quick Release Offset Ratchets: 1/4", 3/8" Dr.
  - 2 - 3/8" Dr. Spark Plug Sockets: 16, 21mm
  - 2 - Universal Joints: 1/4", 3/8" Dr.
  - 2 - 1/4" Dr. Extension Bars: 3", 6" (75, 150mm)
  - 2 - 3/8" Dr. Extension Bars: 3", 6" (75, 150mm)
  - 1 - 3/8" (F) x 1/4" (M) Socket Adaptor
  - 1 - 1/4" Dr. Spinner Handle
  - 1 - 1/4" Dr. Bit Coupler
  - 24 - 1/4" Screwdriver Bits:
    - 4 - Phillips: #0, #1, #2, #3
    - 4 - Slotted: 4, 4.5, 5.5, 6mm
    - 5 - Hex: 3, 4, 5, 6, 7mm
    - 7 - Star: T10, T15, T20, T25, T27, T30, T40
    - 4 - Pozi: #0, #1, #2, #3
- Aluminum Case

### T45909

#### 80pc 1/4" & 3/8" Dr. Socket Set w/ Aluminum Case (SAE & Metric)

Contents:

- 9 - 1/4" Dr. 6pt Sockets:
    - 3/16", 7/32", 1/4", 9/32", 5/16", 11/32", 3/8", 7/16", 1/2"
  - 10 - 1/4" Dr. 6pt Sockets:
    - 4, 4.5, 5, 6, 7, 8, 9, 10, 11, 12mm
  - 7 - 3/8" Dr. 6pt Sockets:
    - 3/8", 7/16", 1/2", 9/16", 5/8", 11/16", 3/4"
  - 8 - 3/8" Dr. 6pt Sockets:
    - 10, 12, 13, 15, 16, 17, 18, 19mm
  - 5 - 3/8" Dr. 6pt Deep Sockets:
    - 3/8", 7/16", 1/2", 9/16", 5/8"
  - 5 - 3/8" Dr. 6pt Deep Sockets:
    - 12, 13, 14, 16, 18mm
  - 2 - Quick Release Offset Ratchets: 1/4", 3/8" Dr.
  - 2 - Universal Joints: 1/4", 3/8" Dr.
  - 2 - 3/8" Dr. Spark Plug Sockets: 5/8", 13/16"
  - 2 - 1/4" Dr. Extension Bars: 3" (75mm), 6" (150mm)
  - 2 - 3/8" Dr. Extension Bars: 3" (75mm), 6" (150mm)
  - 1 - 1/4" Dr. Go-Thru Spinner Handle
  - 1 - 1/4" Dr. Bit Coupler
  - 24 - 1/4" Screwdriver Bits (25mm):
    - 4 - Phillips: #0, #1, #2, #3
    - 4 - Slotted: 4, 4.5, 5.5, 6mm
    - 5 - Hex: 3, 4, 5, 6, 7mm
    - 7 - Star: T10, T15, T20, T25, T27, T30, T40
    - 4 - Pozi: #0, #1, #2, #3
- Aluminum Case

### T45911

#### 48pc Aluminum Case Electrical Tool Set

Contents:

- 6 - Insulated Screwdrivers:
  - 3 - Phillips: #0 x 75, #1 x 100, #2 x 100mm
  - 3 - Slotted: 3 x 75, 4 x 100, 5.5mm x 125mm
- 1 - 175mm Insulated Heavy Duty Diagonal Cutting Pliers
- 1 - 200mm Insulated Combination Pliers
- 1 - 200mm Insulated Long Nose Pliers
- 1 - Electrician Knife
- 1 - Digital Voltage Tester
- 1 - Digital Multi-Meter





- 1 - Electrical Tape
- 1 - 5-LED Flashlight w/ Magnetic Pickup
- 1 - Modular Telephone Plug Crimper
- 1 - 200mm Wire Crimper
- 1 - Cordless Soldering Iron
- 1 - 40W Electric Soldering Iron
- 1 - Solder Sucker
- 1 - Solder Wire
- 4 - Fuse
- 24 - Fuse Terminals
- Aluminum Case

### T45912

#### 34pc 1/2" Dr. Socket & Wrench Set w/ Aluminum Case (Metric)

Contents:

- 20 - 1/2" Dr. 6pt Sockets:
  - 8, 9, 10, 11, 12, 13, 14, 15, 16, 17, 18, 19, 20, 21, 22, 23, 24, 27, 30, 32mm
- 1 - 1/2" Dr. Quick Release Offset Ratchet
- 1 - 1/2" Dr. Universal Joint
- 2 - 1/2" Dr. Extension Bars: 125, 250mm
- 1 - 1/2" Dr. x 15" (380mm) Flexible Handle
- 1 - 3/8" (F) x 1/2" (M) Sliding T-Adaptor
- 8 - Combination Wrenches:
  - 8, 10, 11, 12, 13, 14, 17, 19mm
- Aluminum Case

### T45916

#### 67pc 1/4" & 1/2" Dr. Socket Set w/ Aluminum Case (Metric)

Contents:

- 13 - 1/4" Dr. 6pt Sockets:
  - 4, 4.5, 5, 5.5, 6, 7, 8, 9, 10, 11, 12, 13, 14mm
- 18 - 1/2" Dr. 6pt Sockets:
  - 10, 11, 12, 13, 14, 15, 16, 17, 18, 19, 20, 21, 22, 23, 24, 27, 30, 32mm
- 2 - Quick Release Offset Ratchets: 1/4", 1/2" Dr.
- 2 - Universal Joints: 1/4", 1/2" Dr.
- 2 - 1/2" Dr. Spark Plug Sockets: 16, 21mm
- 2 - 1/4" Dr. Extension Bars: 2" (50mm), 4" (100mm)
- 2 - 1/2" Dr. Extension Bars: 5" (125mm), 10" (250mm)
- 1 - 1/4" Dr. x 4-1/2" (115mm) Sliding T-Handle
- 1 - 3/8" (F) x 1/2" (M) Sliding T-Adaptor
- 1 - 1/4" Dr. Spinner Handle
- 1 - 1/4" x 1/4" Bit Coupler
- 22 - 1/4" Screwdriver Bits (25mm):
  - 4 - Phillips: #0, #1, #2, #3
  - 6 - Slotted: 3, 4, 5, 5.5, 6, 7mm
  - 3 - Hex: 4, 5, 6mm
  - 6 - Star: T15, T20, T25, T27, T30, T40
  - 3 - Pozi: #1, #2, #3
- Aluminum Case

### T45917

#### 77pc 1/4" & 1/2" Dr. Socket Set w/ Aluminum Case (Metric)

Contents:

- 13 - 1/4" Dr. 6pt Sockets:
  - 4, 4.5, 5, 5.5, 6, 7, 8, 9, 10, 11, 12, 13, 14mm
- 18 - 1/2" Dr. 6pt Sockets:
  - 10, 11, 12, 13, 14, 15, 16, 17, 18, 19, 20, 21, 22, 23, 24, 27, 30, 32mm
- 2 - Quick Release Offset Ratchets: 1/4", 1/2" Dr.
- 2 - Universal Joints: 1/4", 1/2" Dr.
- 2 - 1/2" Dr. Spark Plug Sockets: 16, 21mm
- 1 - 1/4" Dr. Extension Bar: 6" (150mm)
- 2 - 1/2" Dr. Extension Bars: 5" (125mm), 10" (250mm)
- 1 - 1/4" Dr. x 4-1/2" (115mm) Sliding T-Handle
- 1 - 3/8" (F) x 1/2" (M) Sliding T-Adaptor
- 7 - Combination Wrenches: 8, 10, 11, 12, 13, 14, 17mm
- 2 - Screwdrivers:
  - 1 - Phillips: #2 x 4" (100mm)

- 1 - Slotted: 1/4" x 6" (6 x 150mm)
- 1 - 1/4" Dr. Spinner Handle
- 1 - 1/4" x 1/4" Bit Adaptor
- 24 - 1/4" Screwdriver Bits (25mm):
  - 4 - Phillips: #0, #1, #2, #3
  - 4 - Slotted: 4, 4.5, 5.5, 6mm
  - 5 - Hex: 3, 4, 5, 6, 7mm
  - 7 - Star: T10, T15, T20, T25, T27, T30, T40
  - 4 - Pozi: #0, #1, #2, #3
- Aluminum Case

### T45970

#### 29pc 1/4" Dr. Fits-All Go-Thru Socket Set

Contents:

- 11 - 13mm Fits-All Go-Thru Sockets:
  - 4.5, 5, 5.5, 6, 7, 8, 9, 10, 11, 12, 13mm
- 1 - 13mm Go-Thru Reversible Offset Ratchet
- 1 - 13mm Go-Thru Deep Socket Adaptor (Converts Standard Sockets to Deep Sockets)
- 1 - 1/4" Dr. x 13mm Quick Release Ratchet Adaptor (Converts Go-Thru Ratchet to Standard Ratchet)
- 1 - 1/4" Dr. x 13mm Go-Thru Socket Adaptor (Allows Standard Ratchets to Work with Fits-All Go-Thru Sockets)
- 1 - 1/4" Dr. x 4" (100mm) Extension Bar
- 1 - 1/4" Dr. Universal Joint
- 1 - 1/4" Dr. Spinner Handle
- 1 - 1/4" Bit Coupler
- 10 - 1/4" Screwdriver Bits (25mm):
  - 2 - Phillips: #1, #2
  - 3 - Slotted: 4, 5, 7mm
  - 3 - Star: T10, T15, T20
  - 2 - Pozi: #1, #2

Blowcase

### T45971

#### 17pc 3/8" Dr. Fits-All Go-Thru Socket Set

Contents:

- 11 - 19mm Fits-All Go-Thru Sockets:
  - 8, 10, 11, 12, 13, 14, 15, 16, 17, 18, 19mm
- 1 - 19mm Go-Thru Reversible Offset Ratchet
- 1 - 3/8" Dr. x 19mm Go-Thru Deep Socket Adaptor (Converts Standard Socket to Deep Socket)
- 1 - 3/8" Dr. x 19mm Quick Release Ratchet Adaptor (Converts Go-Thru Ratchet to Standard Ratchet)
- 1 - 3/8" Dr. x 19mm Go-Thru Socket Adaptor (Allows Standard Ratchet to Work with Fits-All Go-Thru Sockets)
- 1 - 3/8" Dr. x 3" (75mm) Extension Bar
- 1 - 3/8" Dr. x 16mm Spark Plug Socket

Blowcase

### T45972

#### 56pc 1/4" & 3/8" Dr. Fits-All Go-Thru Socket Set

Contents:

- 11 - 13mm Fits-All Go-Thru Sockets:
  - 4.5, 5, 5.5, 6, 7, 8, 9, 10, 11, 12, 13mm
- 10 - 19mm Fits-All Go-Thru Sockets:
  - 10, 11, 12, 13, 14, 15, 16, 17, 18, 19mm
- 2 - Go-Thru Reversible Offset Ratchets: 13, 19mm
- 2 - Go-Thru Deep Socket Adaptors: 13, 19mm (Converts Standard Sockets to Deep Sockets)
- 2 - Quick Release Ratchet Adaptors:
  - 1/4" Dr. x 13mm, 3/8" Dr. x 19mm (Converts Go-Thru Ratchets to Standard Ratchets)
- 2 - Go-Thru Socket Adaptors:
  - 1/4" Dr. x 13mm, 3/8" Dr. x 19mm (Allows Standard Ratchet to Work with Fits-All Go-Thru Sockets)
- 1 - 1/4" Dr. x 13mm Bit Coupler (Converts Bit to Bit Socket)
- 1 - 1/4" Dr. x 4" (100mm) Extension Bar
- 1 - 3/8" Dr. x 3" (75mm) Extension Bar



- 1 - 1/4" Dr. Spinner Handle
- 1 - 1/4" Bit Coupler
- 22 - 1/4" Screwdriver Bits (25mm):
  - 2 - Phillips: #1, #2
  - 5 - Slotted: 2.5, 3, 4, 5, 7mm
  - 5 - Hex: 2, 3, 4, 5, 6mm
  - 6 - Star: T10, T15, T20, T25, T27, T30
  - 2 - Pozi: #1, #2
  - 2 - Robertson: #1, #2

Blowcase

### T45973

#### 73pc 1/4", 3/8" & 1/2" Dr. Fits-All Go-Thru Socket Set

Contents:

- 11 - 13mm Fits-All Go-Thru Sockets:
  - 4.5, 5, 5.5, 6, 7, 8, 9, 10, 11, 12, 13mm
- 10 - 19mm Fits-All Go-Thru Sockets:
  - 10, 11, 12, 13, 14, 15, 16, 17, 18, 19mm
- 6 - 22mm Fits-All Go-Thru Sockets:
  - 20, 22, 24, 27, 30, 32mm
  - (Go-Thru Sockets Apply up to 24mm Only)
- 3 - Go-Thru Reversible Offset Ratchets: 13, 19, 22mm
- 3 - Go-Thru Deep Socket Adaptors: 13, 19, 22mm  
(Converts Standard Sockets to Deep Sockets)
- 3 - Quick Release Ratchet Adaptors:
  - 1/4" Dr. x 13mm, 3/8" Dr. x 19mm, 1/2" Dr. x 22mm
  - (Converts Go-Thru Ratchets to Standard Ratchets)
- 3 - Go-Thru Socket Adaptors:
  - 1/4" Dr. x 13mm, 3/8" Dr. x 19mm, 1/2" Dr. x 22mm
  - (Allows Standard Ratchets to Work with Fits-All Go-Thru Sockets)
- 1 - 1/4" x 13mm Bit Coupler (Converts Bit to Bit Socket)
- 7 - Fits-All Combination Wrenches:
  - 8, 10, 12, 13, 14, 17, 19mm
- 1 - 1/4" Dr. x 4" (100mm) Extension Bar
- 1 - 3/8" Dr. x 3" (75mm) Extension Bar
- 11 - Hex Keys:
  - 1.27, 1.5, 2, 2.5, 3, 3.5, 4, 4.5, 5, 5.5, 6mm
- 1 - 1/4" Dr. Spinner Handle
- 1 - 1/4" Bit Coupler
- 11 - 1/4" Screwdriver Bits (25mm):
  - 2 - Phillips: #1, #2
  - 2 - Slotted: 5, 7mm
  - 2 - Hex: 5, 6mm
  - 3 - Star: T10, T15, T20
  - 2 - Pozi: #1, #2

Blowcase

### T45974

#### 40pc 1/4", 3/8" & 1/2" Dr. Fits-All Go-Thru Socket Set

Contents:

- 11 - 13mm Fits-All Go-Thru Sockets:
  - 4.5, 5, 5.5, 6, 7, 8, 9, 10, 11, 12, 13mm
- 10 - 19mm Fits-All Go-Thru Sockets:
  - 10, 11, 12, 13, 14, 15, 16, 17, 18, 19mm
- 6 - 22mm Fits-All Go-Thru Sockets:
  - 20, 22, 24, 27, 30, 32mm
  - (Go-Thru Sockets Apply up to 24mm Only)
- 3 - Go-Thru Reversible Offset Ratchets: 13, 19, 22mm
- 3 - Go-Thru Deep Socket Adaptors: 13, 19, 22mm  
(Converts Standard Sockets to Deep Sockets)
- 3 - Quick Release Ratchet Adaptors:
  - 1/4" Dr. x 13mm, 3/8" Dr. x 19mm, 1/2" Dr. x 22mm
  - (Converts Go-Thru Ratchets to Standard Ratchets)
- 3 - Go-Thru Socket Adaptors:
  - 1/4" Dr. x 13mm, 3/8" Dr. x 19mm, 1/2" Dr. x 22mm
  - (Allows Standard Ratchets to Work with Fits-All Go-Thru Sockets)
- 1 - 1/4" x 13mm Bit Coupler (Converts Bit to Bit Socket)

Blowcase

### T45980

#### 62pc 1/4" & 3/8" Dr. Fits-All Go-Thru Socket Set

Contents:

- 11 - 13mm Fits-All Go-Thru Sockets:
  - 4.5, 5, 5.5, 6, 7, 8, 9, 10, 11, 12, 13mm
- 10 - 19mm Fits-All Go-Thru Sockets:
  - 10, 11, 12, 13, 14, 15, 16, 17, 18, 19mm
- 2 - Go-Thru Reversible Offset Ratchets: 13, 19mm
- 2 - Go-Thru Deep Socket Adaptors: 13, 19mm  
(Converts Standard Sockets to Deep Sockets)
- 2 - Quick Release Ratchet Adaptors:
  - 1/4" Dr. x 13mm, 3/8" Dr. x 19mm
  - (Converts Go-Thru Ratchets to Standard Ratchets)
- 2 - Go-Thru Socket Adaptors:
  - 1/4" Dr. x 13mm, 3/8" Dr. x 19mm
  - (Allows Standard Ratchets to Work w/ Go-Thru Sockets)
- 1 - 1/4" x 13mm Bit Coupler (Converts Bit to Bit Socket)
- 1 - 3/8" Dr. x 3" (75mm) Extension Bar
- 9 - Hex Keys: 1.5, 2, 2.5, 3, 4, 5, 6, 8, 10mm
- 1 - 1/4" Dr. Spinner Handle
- 1 - 1/4" Bit Coupler
- 20 - 1/4" Screwdriver Bits (25mm):
  - 2 - Phillips: #1, #2
  - 5 - Slotted: 2.5, 3, 4, 5, 7mm
  - 5 - Hex: 2, 3, 4, 5, 6mm
  - 6 - Star: T10, T15, T20, T25, T27, T30
  - 2 - Pozi: #1, #2

Metal Chest

### T45981

#### 82pc 1/4", 3/8" & 1/2" Dr. Fits-All Go-Thru Socket Set

Contents:

- 11 - 13mm Fits-All Go-Thru Sockets:
  - 4.5, 5, 5.5, 6, 7, 8, 9, 10, 11, 12, 13mm
- 10 - 19mm Fits-All Go-Thru Sockets:
  - 10, 11, 12, 13, 14, 15, 16, 17, 18, 19mm
- 6 - 22mm Fits-All Go-Thru Sockets:
  - 20, 22, 24, 27, 30, 32mm
  - (Go-Thru Sockets Apply up to 24mm Only)
- 3 - Go-Thru Reversible Offset Ratchets: 13, 19, 22mm
- 3 - Go-Thru Deep Socket Adaptors:
  - 13, 19, 22mm
  - (Converts Standard Sockets to Deep Sockets)
- 3 - Quick Release Ratchet Adaptors:
  - 1/4" Dr. x 13mm, 3/8" Dr. x 19mm, 1/2" Dr. x 22mm
  - (Converts Go-Thru Ratchets to Standard Ratchets)
- 1 - 1/4" x 13mm Bit Coupler  
(Converts Bit to Bit Socket)
- 6 - Fits-All Combination Wrenches:
  - 8, 10, 12, 13, 14, 17mm
- 1 - 6" (150mm) Long Nose Pliers
- 1 - 7" (175mm) Combination Pliers
- 4 - Screwdrivers:
  - 2 - Phillips: #1 x 3" (75mm), #2 x 4" (100mm)
  - 2 - Slotted: 3/16" x 3" (5 x 75mm), 1/4" x 4" (6 x 100mm)
- 9 - Hex Keys: 1.5, 2, 2.5, 3, 4, 5, 6, 8, 10mm
- 1 - 1/4" Dr. Spinner Handle
- 1 - 1/4" Bit Coupler
- 22 - 1/4" Screwdriver Bits (25mm):
  - 3 - Phillips: #1, #2, #3
  - 5 - Slotted: 2.5, 3, 4, 5, 7mm
  - 5 - Hex: 2, 3, 4, 5, 6mm
  - 6 - Star: T10, T15, T20, T25, T27, T30
  - 3 - Pozi: #1, #2, #3

Metal Chest

### T45990

#### 36pc 1/4" Dr. Fits-All Socket Set

Contents:

- 11 - 1/4" Dr. Fits-All Sockets:
  - 4.5, 5, 5.5, 6, 7, 8, 9, 10, 11, 12, 13mm

- 1 - 1/4" Dr. Quick Release Ratchet (T29860)
- 1 - 1/4" Dr. x 4"(100mm) Extension Bars
- 1 - 1/4" Dr. Universal Joint
- 1 - 1/4" Dr. Spinner Handle
- 1 - 1/4" Bit Coupler
- 20 - 1/4" Screwdriver Bits (25mm):
  - 4 - Phillips: #0, #1, #2, #3
  - 4 - Slotted: 4, 6, 7, 8 mm
  - 7 - Star: T10, T15, T20, T25, T27, T30, T40
  - 5 - Hex: 3, 4, 5, 6, 8 mm

Blowcase

### T45991

#### 33pc 1/4" & 3/8" Dr. Fits-All Socket Set

Contents:

- 10 - 1/4" Dr. Fits-All Sockets: 4, 4.5, 5, 5.5, 6, 7, 8, 9, 10, 11mm
- 8 - 3/8" Dr. Fits-All Sockets: 12, 13, 14, 15, 16, 17, 18, 19mm
- 1 - 1/4" & 3/8" Dual-Drive Stubby Ratchet
- 1 - 3/8" Dr. x 3" (75mm) Extension Bar
- 1 - 3/8" Dr. x 16mm Spark Plug Socket
- 1 - 1/4" Bit Coupler
- 11 - 1/4" Screwdriver Bits (25mm):
  - 2 - Phillips: #1, #2
  - 2 - Slotted: 5, 7mm
  - 3 - Star: T10, T15, T20
  - 2 - Hex: 5, 6mm
  - 2 - Pozi: #1, #2

Blowcase

### T45992

#### 26pc 1/2" Dr. Fits-All Socket Set (Metric)

Contents:

- 20 - 1/2" Dr. Fits-All Sockets
  - 8, 9, 10, 11, 12, 13, 14, 15, 16, 17, 18, 19, 20, 21, 22, 23, 24, 27, 30, 32mm
- 1 - 1/2" Dr. Quick Release Ratchet (T29862)
- 1 - 1/2" Dr. Universal Joint
- 1 - 1/2" Dr. Spark Plug Socket: 21mm
- 1 - 1/2" Dr. Flex Handle: 380mm
- 2 - 1/2" Dr. Extension Bars: 125mm, 250mm

Metal Case

### T45993

#### 21pc 1/2" Dr. Fits-All Socket Set

Contents:

- 16 - 1/2" Dr. Fits-All Sockets:
  - 10, 11, 12, 13, 14, 15, 16, 17, 18, 19, 21, 22, 24, 27, 30, 32mm
- 1 - 1/2" Dr. Quick Release Ratchet (T29862)
- 2 - 1/2" Dr. Extension Bars: 5", 10"
- 1 - 1/2" (M) x 3/8" (F) Sliding T-Adaptor
- 1 - 1/2" Dr. Universal Joint

Blowcase

### T45994

#### 18pc 3/8" Dr. Fits-All Socket Set

Contents:

- 12 - 3/8" Dr. Fits-All Sockets:
  - 8, 9, 10, 11, 12, 13, 14, 15, 16, 17, 18, 19mm
- 1 - 3/8" Dr. Quick Release Ratchet (T29861)
- 1 - 3/8" Dr. Universal Joint
- 2 - 3/8" Dr. Extension Bars: 3", 6" (75mm, 150mm)
- 2 - 3/8" Dr. Spark Plug Sockets:
  - 5/8" (16mm), 13/16" (21mm)

Blowcase

### T45995

#### 51pc 1/4" & 3/8" Dr. Fits-All Socket Set

Contents:

- 11 - 1/4" Dr. Fits-All Sockets:
  - 4.5, 5, 5.5, 6, 7, 8, 9, 10, 11, 12, 13mm

10 - 3/8" Dr. Fits-All Sockets:

- 10, 11, 12, 13, 14, 15, 16, 17, 18, 19mm
- 1 - 1/4" Dr. Quick Release Ratchet (T29860)
- 1 - 3/8" Dr. Quick Release Ratchet (T29861)
- 2 - Universal Joints: 1/4", 3/8" Dr.
- 1 - 1/4" Dr. x 4" (100mm) Extension Bar
- 1 - 3/8" Dr. x 3" (75mm) Extension Bar
- 2 - 3/8" Dr. Spark Plug Sockets: 5/8" (16mm), 13/16" (21mm)
- 1 - 1/4" Dr. Spinner Handle
- 1 - 1/4" Bit Coupler
- 20 - 1/4" Screwdriver Bits (25mm):
  - 2 - Phillips: #1, #2
  - 5 - Slotted: 2.5, 3, 4, 5, 7mm
  - 5 - Hex: 2, 3, 4, 5, 6mm
  - 6 - Star: T10, T15, T20, T25, T27, T30
  - 2 - Pozi: #1, #2

Blowcase

### T45996

#### 94pc 1/4", 3/8" & 1/2" Dr. Fits-All Socket & Wrench Set

Contents:

- 11 - 1/4" Dr. Fits-All Sockets:
  - 4.5, 5, 5.5, 6, 7, 8, 9, 10, 11, 12, 13mm
- 10 - 3/8" Dr. Fits-All Sockets:
  - 10, 11, 12, 13, 14, 15, 16, 17, 18, 19mm
- 8 - 1/2" Dr. Fits-All Sockets:
  - 20, 21, 22, 23, 24, 27, 30, 32mm
- 1 - 1/4" Dr. Quick Release Ratchet (T29860)
- 1 - 3/8" Dr. Quick Release Ratchet (T29861)
- 1 - 1/2" Dr. Quick Release Ratchet (T29862)
- 1 - Universal Joint: 1/4" Dr.
- 1 - Universal Joint: 3/8" Dr.
- 1 - Universal Joint: 1/2" Dr.
- 1 - 1/4" Dr. Extension Bar: 4" (100mm)
- 2 - 3/8" Dr. Extension Bars: 3" (75mm) & 6" (150mm)
- 2 - 1/2" Dr. Extension Bars: 5" (125mm) & 10" (250mm)
- 12 - Fits-All Combination Wrenches:
  - 8, 10, 12, 13, 14, 15, 16, 17, 18, 19, 21, 22mm
- 9 - Hex Wrench Set (SAE):
  - 1/16", 5/64", 3/32", 1/8", 5/32", 3/16", 1/4", 5/16", 3/8"
- 9 - Hex Wrench Set (Metric):
  - 1.5, 2, 2.5, 3, 4, 5, 6, 8, 10mm
- 1 - 1/4" Dr. Go-Thru Spinner Handle
- 1 - 1/4" Bit Coupler
- 22 - 1/4" Screwdriver Bits (25mm):
  - 3 - Phillips: #1, #2, #3
  - 5 - Slotted: 2.5, 3, 4, 5, 7mm
  - 3 - Pozi: #1, #2, #3
  - 5 - Hex: 2, 3, 4, 5, 6mm
  - 6 - Star: T10, T15, T20, T25, T27, T30

### T45997

#### 52pc 1/4" & 3/8" Dr. Fits-All Socket Set

Contents:

- 12 - 1/4" Dr. Fits-All Sockets:
  - 4.5, 5, 5.5, 6, 6.5, 7, 8, 9, 10, 11, 12, 13mm
- 10 - 3/8" Dr. Fits-All Sockets:
  - 10, 11, 12, 13, 14, 15, 16, 17, 18, 19mm
- 2 - Quick Release Offset Ratchets: 1/4" Dr. & 3/8" Dr.
- 2 - Extension Bars: 1/4" Dr x 6", 3/8" Dr. x 3"
- 2 - Universal Joints: 1/4" Dr. & 3/8" Dr.
- 1 - 1/4" Dr. Go-Thru Spinner Handle
- 1 - 1/4" Bit Holder
- 22 - 1/4" Bits:
  - 9 - Slotted: 3, 4 (2pc), 5 (2pc), 5.5, 6, 7mm (2pc)
  - 5 - Phillips: #1, #2 (2pc), #3 (2pc)
  - 2 - Pozi: #2, #3
  - 4 - Star: T10, T15, T20, T25

2 - Hex: 4, 5mm

### T45999

#### 45pc 1/4", 3/8" & 1/2" Dr. Fits-All Socket Set (SAE & Metric)

Contents:

- 4 - 1/4" Dr. Fits-All Sockets:
  - 4.5, 5.5, 6, 7mm
- 11 - 3/8" Dr. Fits-All Sockets:
  - 8, 10, 11, 12, 13, 14, 15, 16, 17, 18, 19mm
- 3 - 1/2" Dr. Fits-All Sockets:
  - 21, 22, 24mm
- 1 - 3/8" & 1/2" Dual-Drive Extendable Ratchet
- 2 - 3/8" & 1/2" Dr. Lighted Extensions
- 1 - 1/4" Dr. Spinner Handle
- 1 - 1/4" Dr. Bit Adaptor
- 2 - Extension Bars: 3/8" Dr. x 3", 3/8" x 6"
- 20 - 1/4" Screwdriver Bits (25mm):
  - 4 - Phillips: #0, #1, #2, #3
  - 4 - Slotted: 4, 5.5, 7, 8mm
  - 7 - Star: T10, T15, T20, T25, T27, T30, T40
  - 5 - Hex: 3, 4, 5, 6, 8mm

### T46055

#### 28pc Multi-Use Tool Set

Contents:

- 1 - 12-LED Flashlight (3 x AAA batteries included)
- 1 - 1-1/2" Rigid Scraper
- 9 - "L" Extra Long Ball Point Hex Wrench Set (S2 Alloy Steel):
  - 1.5, 2, 2.5, 3, 4, 5, 6, 8, 10mm
- 9 - "L" Extra Long Star Wrench (S2 Alloy Steel):
  - T10, T15, T20, T25, T27, T30, T40, T45, T50
- 1 - Heavy Duty Quick Change Utility Knife
- 1 - 5m x 19mm Auto-Lock Tape Measures w/ Steel Case
- 1 - 300mm x 30mm Straight Ruler (Stainless Steel)
- 1 - Quick Change Professional Hacks Saw (Bi-Metal Blades)
- 1 - Heavy Duty Filter Wrench Set (3-1/2" to 3-7/8")
- 1 - O-Ring Hook
- 1 - Scribe Tool
- 1 - Digital Multi-Tester

### T46056

#### 76pc Screwdriver & Wrench Set (SAE & Metric)

Contents:

- 5 - Precision Screwdriver Set (60mm L)
  - 3 - Slotted: 2.0, 3.0, 4.0mm
  - 2 - Phillips: #00, #0
- 9 - "L" Type Hex Wrench Sets (SAE)
  - 1/16", 5/64", 3/32", 1/8", 5/32", 3/16", 1/4", 5/16", 3/8"
- 9 - "L" Type Hex Wrench Sets (Metric)
  - 1.5, 2, 2.5, 3, 4, 5, 6, 8, 10mm
- 8 - Screwdrivers:
  - 4 - Slotted:
    - 5mm x 75mm (3/16" x 3")
    - 6mm x 38mm (1/4" x 1-1/2") Stubby
    - 6mm x 100mm (1/4" x 4")
    - 8mm x 150mm (5/16" x 6")
  - 4 - Phillips:
    - 5mm x 75mm (#1 x 3")
    - 6mm x 38mm (#2 x 1-1/2") Stubby
    - 6mm x 100mm (#2 x 4")
    - 8mm x 150mm (#3 x 6")
- 4 - Nut Drivers
- 9 - Combination Wrenches (SAE):
  - 5/16", 3/8", 7/16", 1/2", 9/16", 3/4", 13/16", 7/8", 15/16"
- 8 - Combination Wrenches (Metric):
  - 8, 10, 12, 13, 14, 15, 17, 18mm
- 22 - 1/4" Screwdriver Bits (25mm):
  - 3 - Phillips: #1, #2, #3
  - 5 - Slotted: 2.5, 3, 4, 5, 7mm
  - 3 - Pozi: #1, #2, #3

- 5 - Hex: 2, 3, 4, 5, 6mm
- 6 - Star: T10, T15, T20, T25, T27, T30
- 1 - 1/4" Dr. Spinner Handle
- 1 - 1/4" Dr. x 1/4" Bit Holder

### T46058

#### 14pc Oil Service Set (Metric)

Contents:

- 1 - All Size Filter Wrench (Upgraded Strap)
- 1 - 3/8" Dr. x 21mm 6pt Socket
- 2 - 3/8" Dr. Spark Plug Sockets: 16, 21mm
- 2 - 3/8" Dr. Extension Bars: 3" (75mm), 10" (250mm)
- 1 - 1/2" (F) x 3/8" (M) Sliding T-Adaptor
- 1 - 3-in-1 Telescopic Inspection Tool
- 6 - Drain Plug Set:
  - 1 - 5/16" Hex x 3/8" Hex
  - 1 - 11mm Square x 12mm Hex
  - 1 - 17mm Hex x 1/2" Hex
  - 1 - 8mm Square x 3/8" Square
  - 1 - 13mm Square x 14mm Hex
  - 1 - 8mm Hex x 10mm Hex

### T46059

#### 8pc Electrical Precision Tool Set

Contents:

- 2 - Slotted Precision Screwdrivers: 2.5 x 65, 3.0 x 65mm
- 2 - Phillips Precision Screwdrivers: #0 x 65, #1 x 65mm
- 1 - 5" Mini Side Cutter
- 1 - 5" Mini End Cutter
- 1 - 5" Mini Long Nose Pliers
- 1 - 5" Mini Flat Nose Pliers

### T46060

#### 3pc Electrical Tools Kit

Contents:

- 1 - Digital Multi-Meter
- 1 - Digital Voltage Tester
- 1 - Electrician Knife

### T46061

#### 8pc Telescopic & Pick Set

Contents:

- 4 - Hooks:
  - 1 - Curved Hook
  - 1 - Offset 45° Hook
  - 1 - 90° Hook
  - 1 - Straight Pick
- 1 - 3-in-1 Telescopic & Lighted Pickup Tool
- 1 - 3 LED Mini Flashlight
- 2 - Telescopic Mirrors (Round & Oval)

### T46070

#### 56pc 1/4" & 1/2" Dr. Tool Set

Contents: (Chrome Vanadium Steel)

- 8 - 1/4" Dr. 6pt Sockets:
  - 4, 5, 6, 7, 8, 9, 10, 11mm
- 10 - 1/2" Dr. 6pt Sockets:
  - 10, 12, 13, 14, 15, 17, 19, 22, 24, 27mm
- 2 - Extension Bars: 1/4" Dr. x 100mm, 1/2" Dr. x 125mm
- 2 - 1/2" Dr. Spark Plug Sockets: 16mm, 21mm
- 2 - Quick Release Offset Ratchets: 1/4", 1/2" Dr.
- 1 - 1/2" Dr. Universal Joint
- 4 - Screwdrivers:
  - 2 - Phillips: #1 x 75mm, #2 x 100mm
  - 2 - Slotted: 4 x 75mm, 6 x 100mm
- 7 - Combination Wrenches:
  - 8, 10, 12, 13, 14, 17, 19mm
- 1 - 7" Combination Pliers
- 1 - 10" Water Pump Pliers
- 1 - 1/4" Dr. Go-Thru Spinner Handle





- 1 - 1/4" Dr. Sliding T-Handle
- 1 - Bit Coupler
- 1 - 300G Hammer
- 4 - Hex Keys: 1.27, 1.5, 2, 2.5
- 10 - 1/4" Screwdriver Bits:
  - 2 - Phillips: #1, #2
  - 3 - Slotted: 4, 5, 7mm
  - 2 - Pozi: #1, #2
  - 3 - Star: T10, T15, T20
- Blowcase

### T46072

#### 83pc 1/4" & 1/2" Dr. Tool Set

Contents:

- 10 - 1/4" Dr. 6pt Socket
  - 4, 5, 6, 7, 8, 9, 10, 11, 12, 13mm
- 5 - 1/4" Dr. 6pt Deep Socket
  - 9, 10, 11, 12, 13mm
- 13 - 1/2" Dr. 6pt Socket
  - 10, 11, 12, 13, 14, 15, 17, 19, 22, 24, 27, 30, 32mm
- 2 - Quick Release Offset Ratchets: 1/4", 1/2" Dr.
- 2 - Universal Joints: 1/4", 1/2" Dr.
- 2 - Extension Bars: 1/4" Dr. x 75mm, 1/2" Dr. x 125mm
- 2 - 1/2" Dr. Spark Plug Sockets: 16, 21mm
- 1 - 1/4" Dr. Go-Thru Spinner Handle
- 8 - Combination Wrenches (Metric)
  - 10, 11, 12, 13, 14, 15, 17, 19mm
- 1 - 10" (250mm) Locking Pliers
- 1 - 10" (250mm) Water Pump Pliers
- 1 - 7" (180mm) Combination Pliers
- 5 - Screwdrivers:
  - 2 - Slotted: 6 x 38mm, 6 x 100mm
  - 3 - Phillips: #1 x 38mm (5 x 38mm), #2 x 100mm (6 x 100mm), #3 x 200mm (8 x 200mm)
- 1 - 300G Hammer
- 4 - Hex Key Set (Metric): 1.27, 1.5, 2, 2.5mm
- 1 - 1/4" Dr. Coupler
- 24 - 1/4" Screwdriver Bits (25mm):
  - 4 - Slotted: 4, 4.5, 5.5, 6mm
  - 4 - Phillips: #0, #1, #2, #3
  - 4 - Pozi: #0, #1, #2, #3
  - 5 - Hex: 3, 4, 5, 6, 7mm
  - 7 - Torx : T10, T15, T20, T25, T27, T30, T40

### T47100

#### 117pc 1/4" & 1/2" Dr. Professional 4-Drawer Tool Chest (Metric)

Contents:

- 11 - 1/4" Dr. 6pt Sockets:
  - 4, 4.5, 5, 5.5, 6, 7, 8, 9, 10, 11, 12mm
- 18 - 1/2" Dr. 6pt Sockets:
  - 10, 11, 12, 13, 14, 15, 16, 17, 18, 19, 20, 21, 22, 23, 24, 27, 30, 32mm
- 1 - 1/4" Dr. Quick Release Offset Ratchet
- 1 - 1/2" Dr. Quick Release Offset Ratchet
- 2 - Universal Joints: 1/4" & 1/2" Dr.
- 2 - 1/2" Dr. Spark Plug Sockets: 16 & 21mm
- 2 - 1/4" Dr. Extension Bars: 50, 100mm
- 2 - 1/2" Dr. Extension Bars: 125, 250mm
- 1 - 1/4" Dr. Sliding T-Bar
- 1 - 1/2" Dr. Sliding T-Handle
- 1 - 150mm Flexible Extension
- 18 - Hex Key Wrenches
  - 9 - Star: T10, T15, T20, T25, T27, T30, T40, T45, T50
  - 9 - Hex: 1.5, 2, 2.5, 3, 4, 5, 6, 8, 10mm
- 5 - Combination Wrenches: 10, 12, 13, 14, 17mm
- 1 - 160mm Diagonal Cutting Pliers
- 1 - 160mm Long Nose Pliers
- 1 - 180mm Combination Pliers
- 1 - 250mm Water Pump Pliers
- 1 - 175mm Locking Grip Pliers

- 1 - Utility Knife
- 8 - Cushioned Grip Screwdrivers:
  - 4 - Phillips: #1 x 80, #2 x 38, #2 x 100, #3 x 150mm
  - 4 - Slotted: 6.5 x 38, 4 x 80, 5.5 x 100, 6.5mm x 150mm
- 1 - 1/4" Dr. Spinner Handle
- 1 - 1/4" Bit Coupler
- 36 - 1/4" Screwdriver Bits (25mm):
  - 5 - Phillips: #0, #1, #2 (2), #3
  - 8 - Slotted: 2, 2.5, 3, 4, 5, 5.5, 6, 7mm
  - 10 - Star: T8, T9, T10, T15, T20, T25, T27, T30, T40, T45
  - 8 - Hex: 2, 2.5, 3, 4, 5, 5.5, 6, 7mm
  - 5 - Pozi: #0, #1, #2 (2), #3

### T47101

#### 126pc 1/4", 3/8" & 1/2" Dr. Professional 4-Drawer Tool Set (SAE & Metric)

Contents:

- 20 - 1/4" Dr. 6pt Sockets:
  - 10 - 4.5, 5, 5.5, 6, 7, 8, 9, 10, 11, 12mm
  - 10 - 5/32", 3/16", 7/32", 1/4", 9/32", 5/16", 11/32", 3/8", 7/16", 1/2"
- 12 - 3/8" Dr. 6pt Sockets:
  - 6 - 13, 14, 15, 16, 17, 19mm
  - 6 - 7/16", 1/2", 9/16", 5/8", 11/16", 3/4"
- 12 - 1/2" Dr. 6pt Sockets
  - 6 - 20, 22, 24, 27, 30, 32mm
  - 6 - 15/16", 1", 1-1/16", 1-1/8", 1-3/16", 1-1/4"
- 1 - 1/4" & 3/8" Dual-Drive Stubby Ratchet
- 1 - 1/2" Dr. Quick Release Offset Ratchet
- 2 - Universal Joints: 3/8" & 1/2" Drive
- 2 - 1/2" Dr. Spark Plug Sockets: 5/8" & 13/16"
- 1 - 1/4" Dr. Extension Bar: 3"
- 1 - 3/8" Dr. Extension Bar: 3"
- 2 - 1/2" Dr. Extension Bars: 5", 10"
- 18 - Hex Key Wrenches
  - 7 - Star: T10, T15, T20, T25, T27, T30, T40
  - 11 - Hex: 1.27, 1.5, 2, 2.5, 3, 3.5, 4, 4.5, 5, 5.5, 6mm
- 5 - Combination Wrenches : 3/8", 7/16", 1/2", 9/16", 11/16"
- 1 - 6" Diagonal Cutting Pliers
- 1 - 6" Long Nose Pliers
- 1 - 7" Combination Pliers
- 1 - 8" Water Pump Pliers
- 1 - 7" Locking Grip Pliers
- 1 - Utility Knife
- 8 - Cushioned Grip Screwdrivers:
  - 4 - Phillips: #1 x 3", #2 x 1-1/2", #2 x 4", #3 x 6"
  - 4 - Slotted: 1/4" x 1-1/2", 1/8" x 3", 3/16" x 4", 1/4" x 6"
- 1 - 1/4" Dr. Spinner Handle
- 1 - 1/4" Bit Coupler
- 33 - 1/4" Screwdriver Bits:
  - 3 - Phillips: #1, #2, #3
  - 4 - Slotted: 4, 5, 6, 7mm
  - 4 - Slotted: 5/32", 3/16", 7/32", 1/4"
  - 8 - Star: T8, T10, T15, T20, T25, T27, T30, T40
  - 4 - Hex: 3, 4, 5, 6mm
  - 4 - Hex: 5/32", 3/16", 7/32", 1/4"
  - 3 - Pozi: #1, #2, #3
  - 3 - Square: S1, S2, S3

### T47103

#### 135pc 1/4" & 1/2" Dr. Professional 6-Drawer Tool Chest

Contents:

- 11 - 1/4" Dr. 6pt Sockets:
  - 4, 5, 5.5, 6, 7, 8, 9, 10, 11, 12, 13mm
- 6 - 1/4" Dr. 6pt Deep Sockets:
  - 6, 7, 8, 10, 12, 13mm
- 18 - 1/2" Dr. 6pt Sockets:
  - 10, 11, 12, 13, 14, 15, 16, 17, 18, 19, 20, 21, 22, 23, 24, 27, 30, 32mm
- 1 - 1/4" Dr. Quick Release Offset Ratchet
- 1 - 1/2" Dr. Quick Release Offset Ratchet



- 2 - Universal Joints: 1/4", 1/2" Dr.
- 2 - 1/2" Dr. Spark Plug Sockets: 16, 21mm
- 1 - 1/2" Dr. x 15" (380mm) Flex Handle
- 2 - 1/4" Dr. Extension Bars: 2" (56mm), 6" (150mm)
- 2 - 1/2" Dr. Extension Bars: 5" (125mm), 10" (250mm)
- 1 - 1/4" Dr. x 4-1/2" (115mm) Sliding T-Handle
- 1 - 3/8" Dr. (F) x 1/2" Dr. (M) Sliding T-Adaptor
- 1 - 1/4" Dr. Flex Extension
- 9 - Combination Wrenches:
  - 10, 11, 12, 13, 14, 15, 17, 18, 19mm
- 5 - Swivel Socket Wrenches:
  - 10 x 11, 12 x 13, 14 x 15, 16 x 17, 18mm x 19mm
- 1 - 8" (200mm) Adjustable Wrench
- 1 - 150mm Diagonal Cutting Pliers
- 1 - 150mm Long Nose Pliers
- 1 - 180mm Combination Pliers
- 1 - 240mm Water Pump Pliers
- 1 - 250mm Lock Grip Pliers
- 1 - 300g Engineer's Hammer
- 1 - 5m x 19mm Tape Measure
- 1 - Center Punch 5 x 9.5 x 120mm
- 5 - Pin Punches (9.5 x 150mm): 3, 4, 5, 6, 8mm
- 1 - Utility Knife
- 1 - Heavy Duty Pocket Magnet Pickup Tool
- 9 - Extra Long Ball Point "L" Hex Wrenches:
  - 1.5, 2, 2.5, 3, 4, 5, 6, 8, 10mm
- 7 - Cushioned Grip Screwdrivers:
  - 3 - Phillips: #1 x 80, #2 x 100, #2 x 38mm
  - 4 - Slotted: 4 x 80, 5.5 x 125, 6.5 x 38, 6.5mm x 150mm
- 6 - Precision Screwdrivers (75mm):
  - 3 - Phillips: #00, #0, #1
  - 3 - Slotted: 2, 2.5, 3mm
- 1 - 1/4" Dr. Spinner Handle
- 1 - 1/4" Dr. x 1/4" Bit Coupler
- 32 - Professional 1/4" Bit Set:
  - 30 - 1/4" Screwdriver Bits (25mm):
    - 4 - Phillips: #1, #2 (2), #3
    - 4 - Slotted: 3, 4, 5, 6mm
    - 4 - Pozi: #1, #2 (2), #3
    - 4 - Hex: 3, 4, 5, 6mm
    - 7 - Star: T10, T15, T20, T25, T27, T30, T40
    - 7 - Tamper-Proof Star: T10, T15, T20, T25, T27, T30, T40
  - 1 - 1/4" Dr. Bit Adaptor
  - 1 - Quick Magnetic Bit Holder (60mm)

**T47104**  
**118pc 1/4", 3/8" & 1/2" Dr. Professional 6-Drawer Tool Chest (Metric)**

Contents:

- 1 **T45030** 37pc 1/4" Dr. Socket Set (Metric)
  - Contents:
    - 10 - 1/4" Dr. 6pt Sockets:
      - 5.5, 6, 7, 8, 9, 10, 11, 12, 13, 14mm
    - 1 - 1/4" Dr. Quick Release Offset Ratchet (T29860)
    - 1 - 1/4" Dr. x 6" Spinner Handle
    - 1 - 1/4" Dr. Sliding T-Handle
    - 2 - 1/4" Dr. Extension Bars: 50, 150mm
    - 1 - 1/4" Dr. Universal Joint
  - 9 - Hex Key Wrenches:
    - 1.5, 2, 2.5, 3, 4, 5, 6, 8, 10mm
  - 11 - 1/4" Screwdriver Bits (25mm):
    - 2 - Phillips: #1, #2
    - 2 - Slotted: 5, 7mm
    - 2 - Pozi: #1, #2
    - 2 - Hex: 5, 6mm
    - 3 - Star: T10, T15, T20
  - 1 - 1/4" Dr. x 1/4" Bit Holder
- 2 **T45240** 19pc 3/8" Dr. Socket Set
  - Contents:
    - 14 - 3/8" Dr. 6pt Sockets:

- 8, 9, 10, 11, 12, 13, 14, 15, 16, 17, 18, 19, 21, 22mm
- 1 - 3/8" Dr. Quick Release Offset Ratchet (T29861)
- 1 - 3/8" Dr. Sliding T-Handle
- 2 - 3/8" Dr. Extension Bars: 75, 150mm
- 1 - 3/8" Dr. Universal Joint

3 **T45425** 22pc 1/2" Dr. Socket Set

Contents:

- 18 - 1/2" Dr. 6pt Sockets:
  - 10, 11, 12, 13, 14, 15, 16, 17, 18, 19, 20, 21, 22, 23, 24, 27, 30, 32mm
- 1 - 1/2" Dr. Quick Release Offset Ratchet (T29862)
- 2 - 1/2" Dr. Extension Bars: 125, 250mm
- 1 - 1/2" Dr. Universal Joint

4 **T40187** 16pc Combination Wrench Set

Contents:

- 6, 7, 8, 9, 10, 11, 12, 13, 14, 15, 16, 17, 18, 19, 22, 24mm

5 **T28951** 3pc Pliers and Wrench Set

Contents:

- 1 - 8" (200mm) Adjustable Wrench
- 1 - 10" (250mm) Lock Grip Pliers
- 1 - 9-1/2" (240mm) Water Pump Pliers

6 **T28952** 3pc Pliers Set

Contents:

- 1 - 8" (200mm) Long Nose Pliers
- 1 - 7" (180mm) Combination Pliers
- 1 - 7" (180mm) Heavy Duty Cutter

7 **T32098** 7pc Super Grip Screwdriver Set (PH & Slotted)

Contents:

- 2 - Phillips: #1 x 80, #2 x 100mm
- 5 - Slotted: 3 x 60, 4 x 80, 5.5 x 125, 6.5 x 150, 8mm x 150mm

8 **T18400** 4pc 8" Pro Style File Set

Contents:

- 1 - Round File
- 1 - Mill File
- 1 - Three-Square File
- 1 - Half-Round File

9 **T20680** 7pc Hammer, Chisel & Punch Set

Contents:

- 1 - Engineer's Hammer
- 1 - Soft Hammer (16oz.)
- 1 - Cold Chisel: 18mm x 165mm
- 3 - Pin Punches: 4 x 150, 5 x 165, 6mm x 180mm
- 1 - Center Punch: #2 x 120mm

**T47105**

**99pc 1/4" & 3/8" Dr. Professional 4-Drawer Tool Chest (Metric)**

Contents:

- 1 **T45033** 31pc 1/4" Dr. Socket Set (Metric)
  - Contents:
    - 13 - 1/4" Dr. Sockets:
      - 4, 4.5, 5, 5.5, 6, 7, 8, 9, 10, 11, 12, 13, 14mm
    - 2 - 1/4" Dr. Extension Bars: 50, 150mm
    - 1 - 1/4" Dr. Spinner Handle
    - 1 - 1/4" Dr. Universal Joint
    - 1 - 1/4" Dr. x 4-1/2" Sliding T-Handle (115mm)
    - 1 - 1/4" Dr. Quick Release Offset Ratchet
    - 1 - Bit Holder: 1/4" Dr. x 1/4"
  - 11 - 1/4" Screwdriver Bits (25mm):
    - 2 - Phillips: #1, #2
    - 2 - Slotted: 5, 7mm
    - 2 - Pozi: #1, #2
    - 2 - Hex: 5, 6mm
    - 3 - Star: T10, T15, T20

2 **T45239** 16pc 3/8" Dr. Socket Set (Metric)

Contents:

- 12 - 3/8" Dr. Sockets:



- 8, 9, 10, 11, 12, 13, 14, 15, 16, 17, 18, 19mm
- 1 - 3/8" Dr. Quick Release Offset Ratchet
- 1 - 3/8" Dr. Sliding T-Handle: 165mm
- 1 - 3/8" Dr. Universal Joint
- 1 - 3/8" Dr. Extension Bar: 75mm
- 3 **T40171** 8pc Combination Wrench Set (10-19mm)  
Contents:  
10, 11, 12, 13, 14, 15, 17, 19mm
- 4 **T28396** 2pc Professional Pliers Set  
Contents:  
1 - 8-1/2" (215mm) High Leverage Combination Pliers  
1 - 9-1/2" (240mm) Water Pump Pliers
- 5 **T28397** 2pc Professional Pliers Set  
Contents:  
1 - 10" (250mm) Locking Pliers  
1 - 10" (250mm) Adjustable Wrench
- 6 **T22939** 27pc Hex & Star Wrench Set (Metric)  
Contents:  
9 - "L" Type Star Wrenches:  
T10, T15, T20, T25, T27, T30, T40, T45, T50  
9 - "L" Type Hex Wrenches:  
1.5, 2, 2.5, 3, 4, 5, 6, 8, 10mm  
9 - "L" Type Long Ball Point Hex Wrenches:  
1.5, 2, 2.5, 3, 4, 5, 6, 8, 10mm
- 7 **T32794** 5pc Screwdriver Set (PH & Slotted)  
Contents:  
3 - Slotted: 4 x 80, 5.5 x 125, 6.5 x 100mm  
2 - Phillips: #1 x 80, #2 x 100mm
- 8 **T23230** 8pc Knife & Tape Set  
Contents:  
1 - Heavy Duty Snap-off Knife (18mm)  
1 - Utility Knife  
5 - Heavy Duty Utility Blades  
1 - Tape Measure: 5m x 19mm
- T47108**  
**122pc 4-Drawer Chest Professional Tool Set**  
Contents:  
1 **T45120** 52pc 1/4" & 3/8" Dr. Socket Set (Metric)  
Contents:  
12 - 1/4" Dr. 6pt Sockets:  
4.5, 5, 5.5, 6, 7, 8, 9, 10, 11, 12, 13, 14mm  
10 - 3/8" Dr. 6pt Sockets:  
10, 11, 12, 13, 14, 15, 16, 17, 18, 19mm  
2 - Quick Release Offset Ratchets: 1/4" Dr. & 3/8" Dr.  
2 - Extension Bars: 1/4" Dr x 6", 3/8" Dr. x 3"  
2 - Universal Joints: 1/4" Dr. & 3/8" Dr.  
1 - 1/4" Dr. Go-Thru Spinner Handle  
1 - 1/4" Bit Holder  
22 - 1/4" Bits:  
9 - Slotted: 3, 4 (2pc), 5 (2pc), 5.5, 6, 7mm (2pc)  
5 - Phillips: #1, #2 (2pc), #3 (2pc)  
2 - Pozi: #2, #3  
4 - Star: T10, T15, T20, T25  
2 - Hex: 4, 5mm
- 2 **T45429** 22pc 1/2" Dr. Socket Set (Metric)  
Contents:  
18 - 1/2" Dr. 6pt Sockets:  
10, 11, 12, 13, 14, 15, 16, 17, 18, 19, 20, 21, 22, 23, 24,  
27, 30, 32mm  
1 - 1/2" Dr. Quick Release Offset Ratchet  
1 - 1/2" Dr. Universal Joint  
2 - 1/2" Dr. Extension Bars: 125, 250mm
- 3 **T42674** 14pc Fits-All Combination Wrench Set (6 - 24mm)  
Contents:  
6, 8, 10, 12, 13, 14, 15, 16, 17, 18, 19, 21, 22, 24mm

- 4 **T40597** 11pc Open-End & Ratcheting Box Wrench Set (6 x7 - 20 x 22mm)  
Contents:  
8 - Open-End Wrenches:  
6 x 7, 8 x 9, 10 x 11, 12 x 13, 14 x 15, 16 x 17, 18 x 19,  
20 x 22mm  
3 - Ratcheting Box Wrenches:  
8 x 10, 12 x 14, 13 x 15mm
- 5 **T28946** 3pc Pliers and Wrench Set  
Contents:  
1 - 8" (200mm) Adjustable & Pipe Stubby Wrench  
1 - 10" (250mm) Lock Grip Pliers  
1 - 9-1/2" (240mm) Water Pump Pliers
- 6 **T28593** 5pc High Leverage Pliers Set  
Contents:  
1 - 5" (125mm) High Leverage Mini Long Nose Pliers  
1 - 5" (125mm) High Leverage Mini Diagonal Cutting Pliers  
1 - 7-1/2" (190mm) High Leverage Long Nose Pliers  
1 - 7-1/2" (190mm) High Leverage Diagonal Cutting Pliers  
1 - 7-1/2" (190mm) High Leverage Combination Pliers
- 7 **T28949** 4pc Snap Ring Pliers Set  
Contents:  
1 - 7" (180mm) Straight Nose Pliers  
1 - 7" (180mm) Bent Nose Internal Pliers  
1 - 7" (180mm) Straight Nose External Pliers  
1 - 7" (180mm) Bent Nose External Pliers
- 8 **T32795** 7pc "Power Grip" Screwdriver Set (PH & Slotted)  
Contents: (Chrome Molybdenum Steel)  
4 - Slotted: 4.0 x 80, 5.5 x 125, 6.5 x 150, 8.0mm x 200mm  
3 - Phillips: #1 x 80mm, #2 x 100mm, #3 x 150mm
- 9 **T20684** 4pc Hammer, Chisel & Punch Set  
Contents:  
1 - 10" Flat Cold Chisel  
1 - 10" Center Punch  
1 - 2-in-1 Quick-Change Hammer (20oz.)  
1 - Engineer's Hammer (16oz.)

- T47111**  
**57pc 1/4" & 3/8" Dr. Professional 1-Drawer Tool Trolley (Metric)**  
Contents:  
1 **T45033** 31pc 1/4" Dr. Socket Set (Metric)  
Contents:  
13 - 1/4" Dr. Sockets:  
4, 4.5, 5, 5.5, 6, 7, 8, 9, 10, 11, 12, 13, 14mm  
2 - 1/4" Dr. Extension Bars: 50, 150mm  
1 - 1/4" Dr. Spinner Handle  
1 - 1/4" Dr. Universal Joint  
1 - 1/4" Dr. x 4-1/2" Sliding T-Handle (115mm)  
1 - 1/4" Dr. Quick Release Offset Ratchet  
1 - Bit Holder: 1/4" Dr. x 1/4"  
11 - 1/4" Screwdriver Bits (25mm):  
2 - Phillips: #1, #2  
2 - Slotted: 5, 7mm  
2 - Pozi: #1, #2  
2 - Hex: 5, 6mm  
3 - Star: T10, T15, T20
- 2 **T45239** 16pc 3/8" Dr. Socket Set (Metric)  
Contents:  
12 - 3/8" Dr. Sockets:  
8, 9, 10, 11, 12, 13, 14, 15, 16, 17, 18, 19mm  
1 - 3/8" Dr. Quick Release Offset Ratchet  
1 - 3/8" Dr. Sliding T-Handle: 165mm  
1 - 3/8" Dr. Universal Joint  
1 - 3/8" Dr. Extension Bar: 75mm
- 3 **T40171** 8pc Combination Wrench Set (10 - 19mm)  
Contents:

10, 11, 12, 13, 14, 15, 17, 19mm

**4 T28396** 2pc Professional Pliers Set

Contents:

- 1 - 8-1/2" (215mm) High Leverage Combination Pliers
- 1 - 9-1/2" (240mm) Water Pump Pliers

**T47116**

**135pc 7-Drawer Wagon Professional Tool Set**

Contents:

**1 T45030** 37pc 1/4" Dr. Socket Set (Metric)

Contents:

10 - 1/4" Dr. 6pt Sockets:

5.5, 6, 7, 8, 9, 10, 11, 12, 13, 14mm

1 - 1/4" Dr. Quick Release Offset Ratchet (T29860)

1 - 1/4" Dr. x 6" Spinner Handle

1 - 1/4" Dr. Sliding T-Handle

2 - 1/4" Dr. Extension Bars: 50, 150mm

1 - 1/4" Dr. Universal Joint

9 - Hex Key Wrenches:

1.5, 2, 2.5, 3, 4, 5, 6, 8, 10mm

11 - 1/4" Screwdriver Bits (25mm):

2 - Phillips: #1, #2

2 - Slotted: 5, 7mm

2 - Pozi: #1, #2

2 - Hex: 5, 6mm

3 - Star: T10, T15, T20

1 - 1/4" Dr. x 1/4" Bit Holder

**2 T45240** 19pc 3/8" Dr. Socket Set

Contents:

14 - 3/8" Dr. 6pt Sockets:

8, 9, 10, 11, 12, 13, 14, 15, 16, 17, 18, 19, 21, 22mm

1 - 3/8" Dr. Quick Release Offset Ratchet (T29861)

1 - 3/8" Dr. Sliding T-Handle

2 - 3/8" Dr. Extension Bars: 75 & 150mm

1 - 3/8" Dr. Universal Joint

**3 T45425** 22pc 1/2" Dr. Socket Set

Contents:

18 - 1/2" Dr. 6pt Sockets:

10, 11, 12, 13, 14, 15, 16, 17, 18, 19, 20, 21, 22, 23, 24, 27, 30, 32mm

1 - 1/2" Dr. Quick Release Offset Ratchet (T29862)

2 - 1/2" Dr. Extension Bars: 125, 250mm

1 - 1/2" Dr. Universal Joint

**4 T40693** 6pc "75-Degree Offset" Box Wrench Set

Contents:

8 x 9, 10 x 11, 12 x 13, 14 x 15, 16 x 17, 18 x 19mm

**5 T40187** 16pc Combination Wrench Set

Contents:

6, 7, 8, 9, 10, 11, 12, 13, 14, 15, 16, 17, 18, 19, 22, 24mm

**6 T40188** 4pc Combination Wrench Set

Contents:

27, 29, 30, 32mm

**7 T28951** 3pc Pliers and Wrench Set

Contents:

1 - 8" (200mm) Adjustable Wrench

1 - 10" (250mm) Lock Grip Pliers

1 - 9-1/2" (240mm) Water Pump Pliers

**8 T28952** 3pc Pliers Set

Contents:

1 - 8" (200mm) Long Nose Pliers

1 - 7" (180mm) Combination Pliers

1 - 7" (180mm) Heavy Duty Cutter

**9 T32173** 7pc Electronic Screwdriver Set (VDE1000V)

Contents:

4 - Slotted:

0.4 x 2.5 x 75, 0.8 x 4 x 100, 1 x 5.5 x 125, 1.2 x 6.5 x 150mm

3 - Phillips:

#0 x 75, #1 x 80, #2 x 100mm

**10 T20680** 7pc Hammer, Chisel & Punch Set

Contents:

1 - Engineer's Hammer

1 - Soft Hammer (16oz.)

1 - Cold Chisel: 18mm x 165mm

3 - Pin Punches: 4 x 150, 5 x 165, 6 x 180mm

1 - Center Punch: #2 x 120mm

**11 T18400** 4pc 8" Pro Style File Set

Contents:

1 - Round File

1 - Mill File

1 - Three-Square File

1 - Half-Round File

**12 T32098** 7pc Super Grip Screwdriver Set (PH & Slotted)

Contents:

5 - Slotted:

3 x 60, 4 x 80, 5.5 x 125, 6.5 x 150, 8mm x 150mm

2 - Phillips:

#1 x 80, #2 x 100mm

**T47117**

**226pc 10-Drawer Wagon Professional Tool Set**

Contents:

**1 T45030** 37pc 1/4" Dr. Socket Set (Metric)

Contents:

10 - 1/4" Dr. 6pt Sockets:

5.5, 6, 7, 8, 9, 10, 11, 12, 13, 14mm

1 - 1/4" Dr. Quick Release Offset Ratchet

1 - 1/4" Dr. Universal Joint

2 - 1/4" Dr. Extension Bars: 50, 150mm

1 - 1/4" Dr. x 115mm Sliding T-Handle

9 - Hex Keys:

1.5, 2, 2.5, 3, 4, 5, 6, 8, 10mm

1 - 1/4" Dr. Spinner Handle

1 - 1/4" Dr. x 1/4" Bit Holder

11 - 1/4" Screwdriver Bits (25mm):

2 - Phillips: #1, #2

2 - Slotted: 5, 7mm

2 - Pozi: #1, #2

2 - Hex: 5, 6mm

3 - Star: T10, T15, T20

**2 T45240** 19pc 3/8" Dr. Socket Set (Metric)

Contents:

14 - 3/8" Dr. 6pt Sockets:

8, 9, 10, 11, 12, 13, 14, 15, 16, 17, 18, 19, 21, 22mm

1 - 3/8" Dr. Quick Release Offset Ratchet

1 - 3/8" Dr. Universal Joint

2 - 3/8" Dr. Extension Bars: 75, 150mm

1 - 3/8" Dr. x 165mm Sliding T-Handle

**3 T45425** 22pc 1/2" Dr. Socket Set (Metric)

Contents:

18 - 1/2" Dr. 6pt Sockets:

10, 11, 12, 13, 14, 15, 16, 17, 18, 19, 20, 21, 22, 23, 24, 27, 30, 32mm

1 - 1/2" Dr. Quick Release Offset Ratchet

2 - 1/2" Dr. Extension Bars: 125, 250mm

1 - 1/2" Dr. Universal Joint

**4 T45208** 23pc 3/8" & 1/2" Dr. Deep Socket, Spark Plug Socket & Stud Puller Set

Contents:

5 - 3/8" Dr. 6pt Deep Sockets:

7, 8, 9, 10, 11mm

8 - 1/2" Dr. 6pt Deep Sockets:

12, 13, 14, 15, 16, 17, 18, 19mm





- 2 - 1/2" Dr. Spark Plug Sockets: 16, 21mm
- 4 - Stud Puller Set (SAE): 1/4", 5/16", 3/8", 7/16"
- 4 - Stud Puller Set (Metric): 6, 8, 10, 12mm
- 5 **T40182** 16pc Combination Wrench Set (15° Offset)  
Contents:  
6, 7, 8, 9, 10, 11, 12, 13, 14, 15, 16, 17, 18, 19, 20, 21mm
- 6 **T40192** 6pc Combination Wrench Set (15° Offset)  
Contents:  
22, 23, 24, 25, 26, 27mm
- 7 **T32095** 8pc Super Grip Screwdriver Set (PH & Slotted)  
Contents:  
4 - Phillips:  
#1x 80mm (3"), #2 x 100mm (4"), #2 x 38mm (1-1/2"),  
#3 x 150mm (6")  
4 - Slotted:  
4 x 80, 5.5 x 125, 6.5 x 38, 6.5mm x 150mm
- 8 **T18407** 9pc Engineers Files & External Thread Restorer File Set  
Contents:  
1 - 8" Mill File  
1 - 8" Round File  
1 - 8" Half-Round File  
1 - Feeler Gauge  
5 - External Thread Restorer File Set
- 9 **T29656** 14pc Punch and Chisel Set  
Contents:  
3 - Flat Chisels: 10, 12, 15mm  
2 - Center Punches: 3, 5mm  
2 - Taper Punches: 3, 5mm  
7 - Pin Punches (150mm): 2, 3, 4, 5, 6, 8, 10mm
- 10 **T46055** 28pc Multi-Use Tool Set  
Contents:  
1 - 12-LED Flashlight (3 x AAA batteries included)  
1 - 1-1/2" Rigid Scraper  
9 - "L" Extra Long Ball Point Hex Wrench Set (S2 Alloy Steel):  
1.5, 2, 2.5, 3, 4, 5, 6, 8, 10mm  
9 - "L" Extra Long Star Wrench (S2 Alloy Steel):  
T10, T15, T20, T25, T27, T30, T40, T45, T50  
1 - Heavy Duty Quick Change Utility Knife  
1 - 5m x 19mm Auto-Lock Tape Measures w/ Steel Case  
1 - 300mm x 30mm Straight Ruler (Stainless Steel)  
1 - Quick Change Professional Hacks Saw (Bi-Metal Blades)  
1 - Heavy Duty Filter Wrench Set (3-1/2" to 3-7/8")  
1 - O-Ring Hook  
1 - Scribe Tool  
1 - Digital Multi-Tester
- 11 **T28964** 12pc Master Pliers Set  
Contents:  
3 - Adjustable Wrenches: 6", 8", 10"  
1 - 7" Heavy Duty Cutting Pliers  
1 - 8" Long Nose Pliers  
1 - 8" Combination Pliers  
1 - 10" Lock Grip Pliers  
1 - 10" Groove Joint Pliers  
1 - 14" Aluminum Pipe Wrench  
1 - 7" Straight Nose Internal Pliers  
1 - 7" Straight Nose External Pliers  
1 - Aviation Tin Snip (Straight Cut)
- 12 **T32179** 8pc Pry & Wrecking Bar Set  
Contents:  
4 - Pry Bar Set: 8", 12", 18", 24"  
4 - Pry Bar & Wrecking Bar Set:  
1 - 15" x 1-3/8" x 1/4" Flat Pry Bar (380 x 35 x 6mm)  
1 - 16" x 5/8" Wrecking Bar (400 x 16mm)  
1 - 10" x 5/8" Cold Chisel (250 x 16mm)  
1 - 24" x 3/4" Aligning Bar (600 x 19mm)
- 13 **T40193** 7pc Combination Wrench Set (15° Offset)

- Contents:  
30, 32, 36, 38, 41, 46, 55mm

#### Drawer 8

- Contents:  
1 - Steel Claw Hammer (1 lb / 16 oz.)  
1 - Steel Ball Pein Hammer (1 lb / 16 oz.)  
1 - Steel Ball Pein Hammer (2 lb / 32 oz.)  
1 - Steel Hammer (4 lb/64 oz.)  
10 - Hollow Punch Kit (Chrome Molybdenum Steel)  
5, 6, 8, 10, 12.7, 16, 20, 25, 32mm 22mm x 120mm Rod  
1 - Digital Micrometer  
1 - Stainless Steel Digital Caliper

#### Drawer 10

- Contents:  
1 - Pointed Chisel w/ Hand Guard (19 x 300mm)  
1 - Cold Chisel w/ Hand Guard (25 x 19 x 300mm)  
1 - Brick Bolster w/ Hand Guard (100 x 22 x 225mm)

#### **T47119**

#### **132pc 7-Drawer Wagon Professional Tool Set**

#### Contents:

- 1 **T45030** 37pc 1/4" Dr. Socket Set (Metric)  
Contents:  
10 - 1/4" Dr. 6pt Sockets:  
5.5, 6, 7, 8, 9, 10, 11, 12, 13, 14  
1 - 1/4" Dr. Quick Release Offset Ratchet  
1 - 1/4" Dr. Universal Joint  
2 - 1/4" Dr. Extension Bars: 50, 150mm  
1 - 1/4" Dr. x 115mm Sliding T-Handle  
9 - Hex Keys: 1.5, 2, 2.5, 3, 4, 5, 6, 8, 10mm  
1 - 1/4" Dr. Spinner Handle  
1 - 1/4" Dr. x 1/4" Bit Holder  
11 - 1/4" Screwdriver Bits (25mm):  
2 - Phillips: #1, #2  
2 - Slotted: 5, 7mm  
2 - Pozzi: #1, #2  
2 - Hex: 5, 6mm  
3 - Star: T10, T15, T20
- 2 **T45240** 19pc 3/8" Dr. Socket Set (Metric)  
Contents:  
14 - 3/8" Dr. 6pt Sockets:  
8, 9, 10, 11, 12, 13, 14, 15, 16, 17, 18, 19, 21, 22  
1 - 3/8" Dr. Quick Release Offset Ratchet  
1 - 3/8" Dr. Universal Joint  
2 - 3/8" Dr. Extension Bars: 75, 150mm  
1 - 3/8" Dr. x 165mm Sliding T-Handle
- 3 **T45425** 22pc 1/2" Dr. Socket Set (Metric)  
Contents:  
18 - 1/2" Dr. 6pt Sockets:  
10, 11, 12, 13, 14, 15, 16, 17, 18, 19, 20, 21, 22, 23,  
24, 27, 30, 32mm  
1 - 1/2" Dr. Quick Release Offset Ratchet  
2 - 1/2" Dr. Extension Bars: 125, 250mm  
1 - 1/2" Dr. Universal Joint
- 4 **T40693** 6pc "75-Degree Offset" Box Wrench Set  
Contents:  
8 x 9, 10 x 11, 12 x 13, 14 x 15, 16 x 17, 18 x 19mm
- 5 **T40187** 16pc Combination Wrench Set  
Contents:  
6, 7, 8, 9, 10, 11, 12, 13, 14, 15, 16, 17, 18, 19, 22, 24mm
- 6 **T40188** 4pc Combination Wrench Set  
Contents:  
27, 29, 30, 32mm
- 7 **T28951** 3pc Pliers and Wrench Set  
Contents:  
1 - 8" (200mm) Adjustable Wrench



- 1 - 10" (250mm) Lock Grip Pliers
- 1 - 9-1/2" (240mm) Water Pump Pliers
- 8 **T28952** 3pc Pliers Set  
Contents:
  - 1 - 8" (200mm) Long Nose Pliers
  - 1 - 7" (180mm) Combination Pliers
  - 1 - 7" (180mm) Heavy Duty Cutter
- 9 **T28953** 4pc Snap Ring Pliers Set  
Contents:
  - 1 - 7" (180mm) Straight Nose Internal Pliers
  - 1 - 7" (180mm) Bent Nose Internal Pliers
  - 1 - 7" (180mm) Straight Nose External Pliers
  - 1 - 7" (180mm) Bent Nose External Pliers
- 10 **T20680** 7pc Hammer, Chisel & Punch Set  
Contents:
  - 1 - Engineer's Hammer
  - 1 - Soft Hammer (16oz.)
  - 1 - Cold Chisel: 18mm x 165mm
  - 3 - Pin Punches: 4 x 150, 5 x 165, 6mm x 180mm
  - 1 - Center Punch: #2 x 120mm
- 11 **T18400** 4pc 8" Pro Style File Set  
Contents:
  - 1 - Round File
  - 1 - Mill File
  - 1 - Three-Square File
  - 1 - Half-Round File
- 12 **T32098** 7pc Super Grip Screwdriver Set (PH & Slotted)  
Contents:
  - 5 - Slotted: 3 x 60, 4 x 80, 5.5 x 125, 6.5 x 150, 8mm x 150mm
  - 2 - Phillips: #1 x 80, #2 x 100mm

## **T47120**

### **116pc 5-Drawer Wagon Professional Tool Set (Metric)**

#### Contents:

- 1 **T45032** 35pc 1/4" Dr. Socket & Bit Set (Metric)  
Contents:
  - 10 - 1/4" Dr. 6pt Sockets:
    - 5.5, 6, 7, 8, 9, 10, 11, 12, 13, 14mm
  - 7 - 1/4" Dr. 6pt Deep Sockets:
    - 6, 7, 8, 10, 11, 12, 13mm
  - 1 - 1/4" Dr. Quick Release Ratchet (T29860)
  - 2 - 1/4" Dr. Extension Bars: 2", 6" (56mm, 150mm)
  - 1 - 1/4" Dr. Spinner Handle
  - 1 - 1/4" Dr. x 1/4" Bit Holder (T12003)
  - 1 - 1/4" Dr. Universal Joint (T33300)
  - 1 - 1/4" Dr. x 4-1/2" Sliding T-Handle (115mm)
  - 11 - 1/4" Screwdriver Bits (25mm):
    - 2 - Phillips: #1, #2
    - 2 - Slotted: 5, 7mm
    - 2 - Pozi: #1, #2
    - 2 - Hex: 5, 6mm
    - 3 - Star: T10, T15, T20
- 2 **T45425** 22pc 1/2" Dr. Socket Set (Metric)  
Contents:
  - 18 - 1/2" Dr. 6pt Sockets:
    - 10, 11, 12, 13, 14, 15, 16, 17, 18, 19, 20, 21, 22, 23, 24, 27, 30, 32mm
  - 1 - 1/2" Dr. Quick Release Offset Ratchet
  - 1 - 1/2" Dr. Universal Joint
  - 2 - 1/2" Dr. Extension Bars: 125, 250mm
- 3 **T40179** 18pc Combination Wrench & Hex Key Set  
Contents:
  - 9 - Combination Wrenches:
    - 8, 10, 12, 13, 14, 16, 17, 18, 19mm
  - 9 - Hex Key Set:
    - 1.5, 2, 2.5, 3, 4, 5, 6, 8, 10mm

- 4 **T28951** 3pc Pliers and Wrench Set  
Contents:
  - 1 - 8" (200mm) Adjustable Wrench
  - 1 - 10" (250mm) Lock Grip Pliers
  - 1 - 9-1/2" (240mm) Water Pump Pliers
- 5 **T28952** 3pc Pliers Set  
Contents:
  - 1 - 8" (200mm) Long Nose Pliers
  - 1 - 7" (180mm) Combination Pliers
  - 1 - 7" (180mm) Heavy Duty Cutter
- 6 **T32098** 7pc Super Grip Screwdriver Set (PH & Slotted)  
Contents:
  - 2 - Phillips: #1 x 80, #2 x 100mm
  - 5 - Slotted: 3 x 60, 4 x 80, 5.5 x 125, 6.5 x 150, 8mm x 150mm
- 7 **T46055** 28pc Multi-Use Tool Set  
Contents:
  - 1 - 12-LED Flashlight (3 x AAA batteries included)
  - 1 - 1-1/2" Rigid Scraper
  - 9 - "L" Extra Long Ball Point Hex Wrench Set (S2 Alloy Steel):
    - 1.5, 2, 2.5, 3, 4, 5, 6, 8, 10mm
  - 9 - "L" Extra Long Star Wrench (S2 Alloy Steel):
    - T10, T15, T20, T25, T27, T30, T40, T45, T50
  - 1 - Heavy Duty Quick Change Utility Knife
  - 1 - 5m x 19mm Auto-Lock Tape Measures w/ Steel Case
  - 1 - 300mm x 30mm Straight Ruler (Stainless Steel)
  - 1 - Quick Change Professional Hacks Saw (Bi-Metal Blades)
  - 1 - Heavy Duty Filter Wrench Set (3-1/2" to 3-7/8")
  - 1 - O-Ring Hook
  - 1 - Scribe Tool
  - 1 - Digital Multi-Tester

## **T47121**

### **244pc 13-Drawer Wagon Tool Set**

#### Contents:

- 1 **T45030** 37pc 1/4" Dr. Socket Set (Metric)  
Contents:
  - 10 - 1/4" Dr. 6pt Sockets:
    - 5.5, 6, 7, 8, 9, 10, 11, 12, 13, 14
  - 1 - 1/4" Dr. Quick Release Offset Ratchet
  - 1 - 1/4" Dr. Universal Joint
  - 2 - 1/4" Dr. Extension Bars: 50, 150mm
  - 1 - 1/4" Dr. x 115mm Sliding T-Handle
  - 9 - Hex Keys: 1.5, 2, 2.5, 3, 4, 5, 6, 8, 10mm
  - 1 - 1/4" Dr. Spinner Handle
  - 1 - 1/4" Dr. x 1/4" Bit Holder
  - 11 - 1/4" Screwdriver Bits (25mm):
    - 2 - Phillips: #1, #2
    - 2 - Slotted: 5, 7mm
    - 2 - Pozi: #1, #2
    - 2 - Hex: 5, 6mm
    - 3 - Star: T10, T15, T20
- 2 **T45240** 19pc 3/8" Dr. Socket Set  
Contents:
  - 14 - 3/8" Dr. 6pt Sockets:
    - 8, 9, 10, 11, 12, 13, 14, 15, 16, 17, 18, 19, 21, 22mm
  - 1 - 3/8" Dr. Quick Release Offset Ratchet (T29861)
  - 1 - 3/8" Dr. Sliding T-Handle
  - 2 - 3/8" Dr. Extension Bars: 75, 150mm
  - 1 - 3/8" Dr. Universal Joint
- 3 **T45425** 22pc 1/2" Dr. Socket Set  
Contents:
  - 18 - 1/2" Dr. 6pt Sockets:
    - 10, 11, 12, 13, 14, 15, 16, 17, 18, 19, 20, 21, 22, 23, 24, 27, 30, 32mm
  - 1 - 1/2" Dr. Quick Release Offset Ratchet (T29862)
  - 2 - 1/2" Dr. Extension Bars: 125, 250mm
  - 1 - 1/2" Dr. Universal Joint

- 4 **T45207** 13pc 3/8" & 1/2" Dr. Deep Socket Set (Metric)  
 Contents:  
 5 - 3/8" Dr. 6pt Deep Sockets:  
 7, 8, 9, 10, 11mm  
 8 - 1/2" Dr. 6pt Deep Sockets:  
 12, 13, 14, 15, 16, 17, 18, 19mm
- 5 **T33225** 20pc 1/2" Dr. Hex Bit Socket Set  
 Contents:  
 10 - 1/2" Dr. Hex Bit Sockets:  
 4, 5, 6, 7, 8, 10, 12, 14, 17, 19mm  
 10 - 1/2" Dr. Hex Bit Sockets:  
 4, 5, 6, 7, 8, 10, 12, 14, 17, 19mm (Length 100mm)
- 6 **T33224** 22pc 1/2" Dr. Star Bit Sockets and External Star Socket Set  
 Contents:  
 9 - 1/2" Dr. Star Bit Sockets:  
 T20, T25, T27, T30, T40, T45, T50, T55, T60  
 4 - 1/2" Dr. Star Bit Sockets (100mm):  
 T40, T45, T50, T55  
 9 - 1/2" Dr. External Star Sockets:  
 E10, E11, E12, E14, E16, E18, E20, E22, E24
- 7 **T45822** 33pc 1/4" & 3/8" Dr. Fits-All Go-Thru Socket Set  
 Contents:  
 12 - 13mm Fits-All Go-Thru Sockets:  
 4.5, 5, 5.5, 6, 6.5, 7, 8, 9, 10, 11, 12, 13mm  
 10 - 19mm Fits-All Go-Thru Sockets:  
 10, 11, 12, 13, 14, 15, 16, 17, 18, 19mm  
 2 - Go-Thru Reversible Ratchets: 13, 19mm  
 1 - 3/8" Dr. Universal Joint  
 2 - Extension Bars: 1/4" Dr. x 4", 3/8" Dr. x 3"  
 2 - Go-Thru Socket Adaptors: 1/4", 3/8" Dr.  
 (Allows Standard Ratchets to work w/ Go-Thru Sockets)  
 1 - 1/4" Dr. Ratchet & Bit Adaptor  
 1 - 3/8" Dr. x 19mm Quick Release Ratchet Adaptors  
 (Converts Go-Thru Ratchet to Traditional Ratchets)  
 2 - Go-Thru Hex Extension Adaptors: 13, 19mm  
 (Converts Standard Sockets to Deep Socket)
- 7 **T40941** 6pc Flexible Socket Wrench Set  
 Content:  
 8 x 9, 10 x 11, 12 x 13, 14 x 15, 16 x 17, 18mm x 19mm
- 9 **T40693** 6pc "75-Degree Offset" Box Wrench Set  
 Contents:  
 8 x 9, 10 x 11, 12 x 13, 14 x 15, 16 x 17, 18 x 19mm
- 10 **T40187** 16pc Combination Wrench Set  
 Contents:  
 6, 7, 8, 9, 10, 11, 12, 13, 14, 15, 16, 17, 18, 19, 22, 24mm
- 11 **T40188** 4pc Combination Wrench Set  
 Content:  
 27, 29, 30, 32mm
- 12 **T41489** 14pc Geared Combination Wrench Set  
 Contents:  
 12 - Wrenches:  
 8, 9, 10, 11, 12, 13, 14, 15, 16, 17, 18, 19mm  
 2 - Adaptors: 1/4" x 13mm, 3/8" x 19mm
- 13 **T28952** 3pc Pliers Set  
 Contents:  
 1 - 8" (200mm) Long Nose Pliers  
 1 - 7" (180mm) Combination Pliers  
 1 - 7" (180mm) Heavy Duty Cutter
- 14 **T28953** 4pc Snap Ring Pliers Set  
 Contents:  
 1 - 7" (180mm) Straight Nose Internal Pliers  
 1 - 7" (180mm) Bent Nose Internal Pliers  
 1 - 7" (180mm) Straight Nose External Pliers  
 1 - 7" (180mm) Bent Nose External Pliers
- 15 **T18400** 4pc 8" Pro Style File Set  
 Contents:  
 1 - Round File  
 1 - Mill File  
 1 - Three-Square File  
 1 - Half-Round File
- 16 **T32098** 7pc Super Grip Screwdriver Set (PH & Slotted)  
 Contents:  
 2 - Phillips: #1 x 80, #2 x 100mm  
 5 - Slotted: 3 x 60, 4 x 80, 5.5 x 125, 6.5 x 150, 8mm x 150mm
- 17 **T22903** 7pc T-Handle Tamper-Proof Star & Star Wrench Set  
 Contents:  
 T10, T15, T20, T25, T27, T30, T40
- 18 **T22904** 7pc T-Handle Ball Point & Hex Wrench Set (Metric)  
 Contents:  
 2.5, 3, 4, 5, 6, 7, 8mm
- T47122**  
**120pc 5-Drawer Wagon Professional Tool Set**  
 Contents:
- 1 **T45030** 37pc 1/4" Dr. Socket Set (Metric)  
 Contents:  
 10 - 1/4" Dr. 6pt Sockets:  
 5.5, 6, 7, 8, 9, 10, 11, 12, 13, 14  
 1 - 1/4" Dr. Quick Release Offset Ratchet  
 1 - 1/4" Dr. Universal Joint  
 2 - 1/4" Dr. Extension Bars: 50, 150mm  
 1 - 1/4" Dr. x 115mm Sliding T-Handle  
 9 - Hex Keys: 1.5, 2, 2.5, 3, 4, 5, 6, 8, 10mm  
 1 - 1/4" Dr. Spinner Handle  
 1 - 1/4" Dr. x 1/4" Bit Holder  
 11 - 1/4" Screwdriver Bits (25mm):  
 2 - Phillips: #1, #2  
 2 - Slotted: 5, 7mm  
 2 - Pozi: #1, #2  
 2 - Hex: 5, 6mm  
 3 - Star: T10, T15, T20
- 2 **T45240** 19pc 3/8" Dr. Socket Set  
 Contents:  
 14 - 3/8" Dr. 6pt Sockets:  
 8, 9, 10, 11, 12, 13, 14, 15, 16, 17, 18, 19, 21, 22mm  
 1 - 3/8" Dr. Quick Release Offset Ratchet (T29861)  
 1 - 3/8" Dr. Sliding T-Handle  
 2 - 3/8" Dr. Extension Bars: 75, 150mm  
 1 - 3/8" Dr. Universal Joint
- 3 **T45425** 22pc 1/2" Dr. Socket Set  
 Contents:  
 18 - 1/2" Dr. 6pt Sockets:  
 10, 11, 12, 13, 14, 15, 16, 17, 18, 19, 20, 21, 22, 23, 24,  
 27, 30, 32mm  
 1 - 1/2" Dr. Quick Release Offset Ratchet (T29862)  
 2 - 1/2" Dr. Extension Bars: 125, 250mm  
 1 - 1/2" Dr. Universal Joint
- 4 **T40693** 6pc "75-Degree Offset" Box Wrench Set  
 Contents:  
 8 x 9, 10 x 11, 12 x 13, 14 x 15, 16 x 17, 18 x 19mm
- 5 **T40187** 16pc Combination Wrench Set  
 Contents:  
 6, 7, 8, 9, 10, 11, 12, 13, 14, 15, 16, 17, 18, 19, 22, 24mm
- 6 **T28951** 3pc Pliers and Wrench Set  
 Contents:  
 1 - 8" (200mm) Adjustable Wrench  
 1 - 10" (250mm) Lock Grip Pliers  
 1 - 9-1/2" (240mm) Water Pump Pliers
- 7 **T28952** 3pc Pliers Set



Contents:

- 1 - 8" (200mm) Long Nose Pliers
- 1 - 7" (180mm) Combination Pliers
- 1 - 7" (180mm) Heavy Duty Cutter

8 **T32098** 7pc Super Grip Screwdriver Set (PH & Slotted)

Contents:

- 5 - Slotted: 3 x 60, 4 x 80, 5.5 x 125, 6.5 x 150, 8mm x 150mm
- 2 - Phillips: #1 x 80, #2 x 100mm

9 **T20680** 7pc Hammer, Chisel & Punch Set

Contents:

- 1 - Engineer's Hammer
- 1 - Soft Hammer (16oz.)
- 1 - Cold Chisel: 18mm x 165mm
- 3 - Pin Punches: 4 x 150, 5 x 165, 6mm x 180mm
- 1 - Center Punch: #2 x 120mm

**T47123**

**196pc 5-Drawer Wagon Professional Tool Set (SAE & Metric)**

1 **T45535** 108pc 1/4", 3/8" & 1/2" Dr. Socket Set (SAE & Metric)

Contents:

- 7 - 1/2" Dr. 6pt Sockets:
  - 3/4", 13/16", 7/8", 15/16", 1", 1-1/16", 1-1/8"
- 8 - 1/2" Dr. 6pt Sockets:
  - 17, 18, 19, 20, 21, 22, 23, 24mm
- 9 - 3/8" Dr. 6pt Sockets:
  - 3/8", 7/16", 1/2", 9/16", 5/8", 11/16", 3/4", 13/16", 7/8"
- 10 - 3/8" Dr. 6pt Sockets:
  - 10, 11, 12, 13, 14, 15, 16, 17, 18, 19mm
- 11 - 1/4" Dr. 6pt Sockets:
  - 5/32", 3/16", 7/32", 1/4", 9/32", 5/16", 11/32", 3/8", 7/16", 1/2", 9/16"
- 11 - 1/4" Dr. 6pt Sockets:
  - 4, 5, 6, 7, 8, 9, 10, 11, 12, 13, 14mm
- 5 - 1/4" Dr. 6pt Deep Sockets: 1/4", 9/32", 5/16", 3/8", 7/16"
- 5 - 1/4" Dr. 6pt Deep Sockets: 7, 8, 9, 10, 11mm
- 4 - 1/2" Dr. 6pt Deep Sockets: 3/4", 13/16", 7/8", 15/16"
- 4 - 1/2" Dr. 6pt Deep Sockets: 17, 18, 19, 21mm
- 5 - 3/8" Dr. 6pt Deep Sockets: 1/2", 9/16", 5/8", 3/4", 13/16"
- 5 - 3/8" Dr. 6pt Deep Sockets: 10, 13, 14, 15, 16mm
- 3 - Universal Joints: 1/4", 3/8", 1/2" Dr.
- 2 - 3/8" Dr. Spark Plug Sockets: 5/8", 13/16"
- 3 - Extension Bars:
  - 1/4" x 4" (100mm), 3/8" x 6" (150mm), 1/2" x 5" (125mm)
- 1 - 1/2" Dr. Flexible Handle: 15" (380mm)
- 3 - Quick Release Ratchets: 1/4", 3/8", 1/2" Dr.
- 12 - 3/8" Dr. Bit Sockets:
  - 6 - Hex: 5/16", 3/8", 6, 7, 8, 10mm
  - 6 - Star: T30, T40, T45, T47, T50, T55

2 **T46056** 76pc Screwdriver & Wrench Set (SAE & Metric)

Contents:

- 5 - Precision Screwdriver Set (60mm L)
  - 3 - Slotted: 2.0, 3.0, 4.0mm
  - 2 - Phillips: #00, #0
- 9 - "L" Type Hex Wrench Sets (SAE)
  - 1/16", 5/64", 3/32", 1/8", 5/32", 3/16", 1/4", 5/16", 3/8"
- 9 - "L" Type Hex Wrench Sets (Metric)
  - 1.5, 2, 2.5, 3, 4, 5, 6, 8, 10mm
- 8 - Screwdrivers:
  - 4 - Slotted:
    - 5mm x 75mm (3/16" x 3")
    - 6mm x 38mm (1/4" x 1-1/2") Stubby
    - 6mm x 100mm (1/4" x 4")
    - 8mm x 150mm (5/16" x 6")
  - 4 - Phillips:
    - 5mm x 75mm (#1 x 3")
    - 6mm x 38mm (#2 x 1-1/2") Stubby
    - 6mm x 100mm (#2 x 4")
    - 8mm x 150mm (#3 x 6")

- 4 - Nut Drivers: 6, 8, 10, 11mm
- 9 - Combination Wrenches (SAE):
  - 5/16", 3/8", 7/16", 1/2", 9/16", 3/4", 13/16", 7/8", 15/16"
- 8 - Combination Wrenches (Metric):
  - 8, 10, 12, 13, 14, 15, 17, 18mm
- 22 - 1/4" Screwdriver Bits (25mm):
  - 3 - Phillips: #1, #2, #3
  - 5 - Slotted: 2.5, 3, 4, 5, 7mm
  - 3 - Pozi: #1, #2, #3
  - 5 - Hex: 2, 3, 4, 5, 6mm
  - 6 - Star: T10, T15, T20, T25, T27, T30
- 1 - 1/4" Dr. Spinner Handle
- 1 - 1/4" Dr. x 1/4" Bit Holder

3 **T28964** 12pc Master Pliers Set

Contents:

- 3 - Adjustable Wrenches:
  - 6" (150mm), 8" (200mm), 10" (250mm)
- 1 - 7" (180mm) Heavy-Duty Cutting Pliers
- 1 - 8" (200mm) Long Nose Pliers
- 1 - 8" (200mm) Combination Pliers
- 1 - 10" (250mm) Lock Grip Pliers
- 1 - 10" (250mm) Groove Joint Pliers
- 1 - 14" (355mm) Aluminum Pipe Wrench
- 1 - 7" (180mm) Straight Nose Internal Pliers
- 1 - 7" (180mm) Straight Nose External Pliers
- 1 - Aviation Tin Snip (Straight Cut)

**T47125**

**135pc 5-Drawer Wagon Professional Tool Set**

Contents:

- 1 **T45996** 94pc 1/4", 3/8" & 1/2" Fits-All Socket & Wrench Set
  - Contents:
    - 11 - 1/4" Dr. Fits-All Sockets:
      - 4.5, 5, 5.5, 6, 7, 8, 9, 10, 11, 12, 13mm
    - 10 - 3/8" Dr. Fits-All Sockets:
      - 10, 11, 12, 13, 14, 15, 16, 17, 18, 19mm
    - 8 - 1/2" Dr. Fits-All Sockets:
      - 20, 21, 22, 23, 24, 27, 30, 32mm
    - 1 - 1/4" Dr. Quick Release Ratchet (T29860)
    - 1 - 3/8" Dr. Quick Release Ratchet (T29861)
    - 1 - 1/2" Dr. Quick Release Ratchet (T29862)
    - 1 - Universal Joint: 1/4" Dr.
    - 1 - Universal Joint: 3/8" Dr.
    - 1 - Universal Joint: 1/2" Dr.
    - 1 - 1/4" Dr. Extension Bar: 4" (100mm)
    - 2 - 3/8" Dr. Extension Bars: 3" (75mm) & 6" (150mm)
    - 2 - 1/2" Dr. Extension Bars: 5" (125mm) & 10" (250mm)
- 12 - Fits-All Combination Wrenches:
  - 8, 10, 12, 13, 14, 15, 16, 17, 18, 19, 21, 22mm
- 9 - Hex Wrench Set (SAE):
  - 1/16", 5/64", 3/32", 1/8", 5/32", 3/16", 1/4", 5/16", 3/8"
- 9 - Hex Wrench Set (Metric):
  - 1.5, 2, 2.5, 3, 4, 5, 6, 8, 10mm
- 1 - 1/4" Dr. Go-Thru Spinner Handle
- 1 - 1/4" Bit Coupler
- 22 - 1/4" Screwdriver Bits (25mm):
  - 3 - Phillips: #1, #2, #3
  - 5 - Slotted: 2.5, 3, 4, 5, 7mm
  - 3 - Pozi: #1, #2, #3
  - 5 - Hex: 2, 3, 4, 5, 6mm
  - 6 - Star: T10, T15, T20, T25, T27, T30

2 **T28964** 12pc Master Pliers Set

Contents:

- 3 - Adjustable Wrenches:
  - 6" (150mm), 8" (200mm), 10" (250mm)
- 1 - 7" (180mm) Heavy-Duty Cutting Pliers
- 1 - 8" (200mm) Long Nose Pliers
- 1 - 8" (200mm) Combination Pliers
- 1 - 10" (250mm) Lock Grip Pliers





- 1 - 10" (250mm) Groove Joint Pliers
- 1 - 14" (355mm) Aluminum Pipe Wrench
- 1 - 7" (180mm) Straight Nose Internal Pliers
- 1 - 7" (180mm) Straight Nose External Pliers
- 1 - Aviation Tin Snip (Straight Cut)

**3 T32098** 7pc Super Grip Screwdriver Set (PH & Slotted)

Contents:

- 5 - Slotted:
  - 3 x 60, 4 x 80, 5.5 x 125, 6.5 x 150, 8mm x 150mm
- 2 - Phillips:
  - #1 x 80, #2 x 100mm

**4 T23346** 18pc Multi-Use Tool Set

Contents:

- 9 - Quick-Clamp Recip Saw & Bit Driver
  - 1 - Metal Saw
  - 1 - Wood Saw
  - 1 - Bit Driver
  - 6 - 1/4" Dr. Bits:
    - 2 - Slotted: 3/16", 1/4"
    - 2 - Phillips: #1, #2
    - 2 - Star: T15, T20
- 2 - Auto-Lock Tape Measure (Stainless Steel Case)
  - 3m x 16mm, 5m x 19mm
- 1 - Auto Lock Snap-Off Knife
- 1 - Utility Knife
- 5 - Utility Knife Replacement Blades

**5 T18400** 4pc 8" Pro Style File Set

Contents:

- 1 - Round File
- 1 - Mill File
- 1 - Three-Square File
- 1 - Half-Round File

**T47126**

**155pc 7-Drawer Wagon Professional Tool Set (SAE & Metric)**

Contents:

**1 T45996** 94pc 1/4", 3/8" & 1/2" Fits-All Socket & Wrench Set

Contents:

- 11 - 1/4" Dr. Fits-All Sockets:
  - 4.5, 5, 5.5, 6, 7, 8, 9, 10, 11, 12, 13mm
- 10 - 3/8" Dr. Fits-All Sockets:
  - 10, 11, 12, 13, 14, 15, 16, 17, 18, 19mm
- 8 - 1/2" Dr. Fits-All Sockets:
  - 20, 21, 22, 23, 24, 27, 30, 32mm
- 1 - 1/4" Dr. Quick Release Ratchet (T29860)
- 1 - 3/8" Dr. Quick Release Ratchet (T29861)
- 1 - 1/2" Dr. Quick Release Ratchet (T29862)
- 1 - Universal Joint: 1/4" Dr.
- 1 - Universal Joint: 3/8" Dr.
- 1 - Universal Joint: 1/2" Dr.
- 1 - 1/4" Dr. Extension Bar: 4" (100mm)
- 2 - 3/8" Dr. Extension Bars: 3" (75mm) & 6" (150mm)
- 2 - 1/2" Dr. Extension Bars: 5" (125mm) & 10" (250mm)
- 12 - Fits-All Combination Wrenches:
  - 8, 10, 12, 13, 14, 15, 16, 17, 18, 19, 21, 22mm
- 9 - Hex Wrench Set (SAE):
  - 1/16", 5/64", 3/32", 1/8", 5/32", 3/16", 1/4", 5/16", 3/8"
- 9 - Hex Wrench Set (Metric):
  - 1.5, 2, 2.5, 3, 4, 5, 6, 8, 10mm
- 1 - 1/4" Dr. Go-Thru Spinner Handle
- 1 - 1/4" Bit Coupler
- 22 - 1/4" Screwdriver Bits (25mm):
  - 3 - Phillips: #1, #2, #3
  - 5 - Slotted: 2.5, 3, 4, 5, 7mm
  - 3 - Pozi: #1, #2, #3
  - 5 - Hex: 2, 3, 4, 5, 6mm
  - 6 - Star: T10, T15, T20, T25, T27, T30

**2 T28964** 12pc Master Pliers Set

Contents:

- 3 - Adjustable Wrenches:
  - 6" (150mm), 8" (200mm), 10" (250mm)
- 1 - 7" (180mm) Heavy Duty Cutting Pliers
- 1 - 8" (200mm) Long Nose Pliers
- 1 - 8" (200mm) Combination Pliers
- 1 - 10" (250mm) Lock Grip Pliers
- 1 - 10" (250mm) Groove Joint Pliers
- 1 - 14" (355mm) Aluminum Pipe Wrench
- 1 - 7" (180mm) Straight Nose Internal Pliers
- 1 - 7" (180mm) Straight Nose External Pliers
- 1 - Aviation Tin Snip (Straight Cut)

**3 T32098** 7pc Super Grip Screwdriver Set (PH & Slotted)

Contents:

- 5 - Slotted:
  - 3 x 60, 4 x 80, 5.5 x 125, 6.5 x 150, 8mm x 150mm
- 2 - Phillips:
  - #1 x 80, #2 x 100mm

**4 T23346** 18pc Multi-Use Tool Set

Contents:

- 9 - Quick-Clamp Recip Saw & Bit Driver
  - 1 - Metal Saw
  - 1 - Wood Saw
  - 1 - Bit Driver
  - 6 - 1/4" Dr. Bits:
    - 2 - Slotted: 3/16", 1/4"
    - 2 - Phillips: #1, #2
    - 2 - Star: T15, T20
- 2 - Auto-Lock Tape Measure (Stainless Steel Case)
  - 3m x 16mm, 5m x 19mm
- 1 - Auto Lock Snap-Off Knife
- 1 - Utility Knife
- 5 - Utility Knife Replacement Blades

**5 T18400** 4pc 8" Pro Style File Set

Contents:

- 1 - Round File
- 1 - Mill File
- 1 - Three-Square File
- 1 - Half-Round File

**6 T32190** 8pc Electrical Screwdriver Set (VDE1000V)

Contents:

- 3 - Phillips: #0 x 75, #1 x 100, #2 x 100mm
- 4 - Slotted: 3.0 x 75, 4.0 x 100, 5.5 x 125, 6.5 x 150mm
- 1 - Circuit Tester: 120V ~ 250V

**7 T42678** 4pc Fits-All Combination Wrench Set

Contents:

- 24, 27, 30, 32mm

**8 T46059** 8pc Electrical Precision Tool Set

Contents:

- 2 - Slotted Precision Screwdrivers: 2.5 x 65, 3.0 x 65mm
- 2 - Phillips Precision Screwdrivers: #0 x 65, #1 x 65mm
- 1 - 5" Mini Side Cutter
- 1 - 5" Mini End Cutter
- 1 - 5" Mini Long Nose Pliers
- 1 - 5" Mini Flat Nose Pliers

**T47130**

**69pc 1/4" & 3/8" Dr. Tool Set w/ 3-Tier Canti-Lever Metal Case (Metric)**

Contents:

- 11 - 1/4" Dr. 6pt Sockets:
  - 4, 4.5, 5, 5.5, 6, 7, 8, 9, 10, 11, 12mm
- 9 - 3/8" Dr. 6pt Sockets:
  - 10, 12, 13, 14, 15, 16, 17, 18, 19mm
- 1 - 1/4" & 3/8" Dual-Drive Extendable Stubby Ratchet
- 1 - 1/4" Dr. Extension Bar: 4" (100mm)
- 1 - 3/8" Dr. Extension Bar: 3" (75mm)

- 5 - Combination Wrenches: 10, 12, 13, 14, 17mm
- 1 - Bit Holder: 1/4" Dr. x 1/4" (6mm)
- 1 - 1/4" Dr. Spinner Handle
- 1 - 6" Long Nose Pliers
- 1 - 7" Combination Pliers
- 1 - 8" Stubby Adjustable Wrench
- 1 - 10" Box Joint Water Pump Pliers
- 1 - 10" Locking Grip Pliers
- 9 - Hex Wrenches: 1.5, 2, 2.5, 3, 4, 5, 6, 8, 10mm
- 5 - Screwdrivers:
  - 2 - Phillips: #0 x 3-1/8" (80mm), #2 x 4" (100mm)
  - 3 - Slotted: 1/8" x 3-1/8" (3 x 80mm), 1/4" x 4" (6.5 x 100mm), 5/16" x 6" (8 x 150mm)
- 20 - 1/4" Dr. Bit Sockets:
  - 2 - Phillips: #1, #2
  - 4 - Slotted: 4, 5.5, 7, 8mm
  - 6 - Hex: 3, 4, 5, 6, 7, 8mm
  - 6 - Star: T10, T15, T20, T25, T27, T30
  - 2 - Pozi: #1, #2
- 3 Tier Canti-Lever Metal Case

### T47131

#### 76pc 1/4" & 1/2" Dr. Tool Set w/ 5-Tier Canti-Lever Metal Case (Metric)

- Contents:
- 13 - 1/4" Dr. 6pt Sockets:
    - 4, 4.5, 5, 5.5, 6, 7, 8, 9, 10, 11, 12, 13, 14mm
  - 18 - 1/2" Dr. 6pt Sockets:
    - 10, 11, 12, 13, 14, 15, 16, 17, 18, 19, 20, 21, 22, 23, 24, 27, 30, 32mm
  - 1 - 1/4" Dr. Quick Release Offset Ratchet
  - 1 - 1/2" Dr. Quick Release Offset Ratchet
  - 1 - Universal Joint: 1/2" Dr.
  - 1 - 1/4" Dr. Extension Bar: 4" (100mm)
  - 2 - 1/2" Dr. Extension Bars: 5" (125mm), 10" (250mm)
  - 1 - 3/8" (F) x 1/2" (M) Sliding T-Adaptor
  - 12 - 45 Degree Offset Combination Wrenches:
    - 8, 10, 12, 13, 14, 15, 17, 18, 19, 20, 21, 22mm
  - 1 - 1/4" Dr. Spinner Handle
  - 1 - 6" Long Nose Pliers
  - 1 - 7" Combination Pliers
  - 1 - 10" Box Joint Water Pump Pliers
  - 1 - 10" Locking Grip Pliers
  - 1 - 5m x 19mm Tape Measure
  - 1 - Utility Knife
  - 5 - Utility Knife Replacement Blades
  - 9 - Hex Wrenches: 1.5, 2, 2.5, 3, 4, 5, 6, 8, 10mm
  - 5 - Screwdrivers:
    - 2 - Phillips: #0 x 3-1/8" (80mm), #2 x 4" (100mm)
    - 3 - Slotted: 1/8" x 3-1/8" (3 x 80mm), 1/4" x 4" (6.5 x 100mm), 5/16" x 6" (8 x 150mm)
  - 5 Canti-Lever Metal Case

### T47140

#### 177pc 7-Drawer Wagon Professional Tool Set

- Contents:
- 1 **T45997** 52pc 1/4" & 3/8" Dr. Fits-All Socket Set
 

Contents:

    - 12 - 1/4" Dr. Fits-All Sockets:
      - 4.5, 5, 5.5, 6, 6.5, 7, 8, 9, 10, 11, 12, 13mm
    - 10 - 3/8" Dr. Fits-All Sockets:
      - 10, 11, 12, 13, 14, 15, 16, 17, 18, 19mm
    - 2 - Quick Release Offset Ratchets: 1/4" Dr. & 3/8" Dr.
    - 2 - Extension Bars: 1/4" Dr x 6", 3/8" Dr. x 3"
    - 2 - Universal Joints: 1/4" Dr. & 3/8" Dr.
    - 1 - 1/4" Dr. Go-Thru Spinner Handle
    - 1 - 1/4" Bit Holder
  - 22 - 1/4" Bits:
    - 9 - Slotted: 3, 4 (2pc), 5 (2pc), 5.5, 6, 7mm (2pc)
    - 5 - Phillips: #1, #2 (2pc), #3 (2pc)

- 2 - Pozi: #2, #3
- 4 - Star: T10, T15, T20, T25
- 2 - Hex: 4, 5mm

#### 2 **T45847** 22pc 1/2" Dr. Socket Set

Contents:

- 18 - 1/2" Dr. Fits-All Sockets:
  - 10, 11, 12, 13, 14, 15, 16, 17, 18, 19, 20, 21, 22, 23, 24, 27, 30, 32mm
- 1 - 1/2" Dr. Quick Release Offset Ratchet
- 1 - 1/2" Dr. Universal Joint
- 2 - 1/2" Dr. Extension Bars: 125, 250mm

#### 3 **T40596** 10pc Open-End Wrench Set (6 x 7 - 30 x 32mm)

Contents:

- 6 x 7, 8 x 9, 10 x 11, 12 x 13, 14 x 15, 16 x 17, 18 x 19, 20 x 22, 24 x 27, 30 x 32mm

#### 4 **T42674** 14pc Fits-All Combination Wrench Set (6 - 24mm)

Contents:

- 6, 8, 10, 12, 13, 14, 15, 16, 17, 18, 19, 21, 22, 24mm

#### 5 **T42676** 3pc Fits-All Combination Wrench Set

Contents:

- 27, 30, 32mm

#### 6 **T22937** 42pc Hex & Star Wrench Set (Metric & SAE)

Contents:

- 7 - Folding Hex Wrench Set
  - 1.5, 2, 2.5, 3, 4, 5, 6mm
- 8 - Folding Tamper-Proof Star Wrench Set
  - T8, T10, T15, T20, T25, T27, T30, T40
- 9 - "L" Type Star Wrenches:
  - T10, T15, T20, T25, T27, T30, T40, T45, T50
- 9 - "L" Type Long Ball Point Hex Wrenches (SAE):
  - 1/16", 5/64", 3/32", 1/8", 5/32", 3/16", 1/4", 5/16", 3/8"
- 9 - "L" Type Long Hex Wrenches (Metric):
  - 1.5, 2, 2.5, 3, 4, 5, 6, 8, 10mm

#### 7 **T28593** 5pc High Leverage Pliers Set

Contents:

- 1 - 5" (125mm) High Leverage Mini Long Nose Pliers
- 1 - 5" (125mm) High Leverage Mini Diagonal Cutting Pliers
- 1 - 7-1/2" (190mm) High Leverage Long Nose Pliers
- 1 - 7-1/2" (190mm) High Leverage Diagonal Cutting Pliers
- 1 - 7-1/2" (190mm) High Leverage Combination Pliers

#### 8 **T28946** 3pc Pliers and Wrench Set

Contents:

- 1 - 8" (200mm) Adjustable & Pipe Stubby Wrench
- 1 - 10" (250mm) Lock Grip Pliers
- 1 - 9-1/2" (240mm) Water Pump Pliers

#### 9 **T28949** 4pc Snap Ring Pliers Set

Contents:

- 1 - 7" (180mm) Straight Nose Pliers
- 1 - 7" (180mm) Bent Nose Internal Pliers
- 1 - 7" (180mm) Straight Nose External Pliers
- 1 - 7" (180mm) Bent Nose External Pliers

#### 10 **T32795** 7pc "Power Grip" Screwdriver Set (PH & Slotted)

Contents: (Chrome Molybdenum Steel)

- 4 - Slotted: 4.0 x 80, 5.5 x 125, 6.5 x 150, 8.0mm x 200mm
- 3 - Phillips: #1 x 80mm, #2 x 100mm, #3 x 150mm

#### 11 **T29642** 11pc Punch & Chisel Set

Contents:

- 5 - Pin Punches: 2 x 140, 3 x 150, 4 x 180, 5 x 200, 6 x 210mm
- 3 - Taper Punches: 4 x 185, 5 x 185, 6 x 185mm
- 1 - Center Punch: 2.5 x 185mm
- 2 - Cold Chisels: 12 x 160, 16 x 170mm

#### 12 **T20684** 4pc Hammer, Chisel & Punch Set

Contents:

- 1 - 10" Flat Cold Chisel
- 1 - 10" Center Punch
- 1 - 2-in-1 Quick-Change Hammer (20oz.)

1 - Engineer's Hammer (16oz.)

## T47141

### 231pc 7-Drawer Wagon Professional Tool Set

Contents:

- 1 **T45120** 52pc 1/4" & 3/8" Dr. Socket Set (Metric)
  - Contents:
  - 12 - 1/4" Dr. 6pt Sockets:
    - 4.5, 5, 5.5, 6, 7, 8, 9, 10, 11, 12, 13, 14mm
  - 10 - 3/8" Dr. 6pt Sockets:
    - 10, 11, 12, 13, 14, 15, 16, 17, 18, 19mm
  - 2 - Quick Release Offset Ratchets: 1/4" Dr. & 3/8" Dr.
  - 2 - Extension Bars: 1/4" Dr x 6", 3/8" Dr. x 3"
  - 2 - Universal Joints: 1/4" Dr. & 3/8" Dr.
  - 1 - 1/4" Dr. Go-Thru Spinner Handle
  - 1 - 1/4" Bit Holder
  - 22 - 1/4" Bits:
    - 9 - Slotted: 3, 4 (2pc), 5 (2pc), 5.5, 6, 7mm (2pc)
    - 5 - Phillips: #1, #2 (2pc), #3 (2pc)
    - 2 - Pozzi: #2, #3
    - 4 - Star: T10, T15, T20, T25
    - 2 - Hex: 4, 5mm
- 2 **T45429** 22pc 1/2" Dr. Socket Set (Metric)
  - Contents:
  - 18 - 1/2" Dr. 6pt Sockets:
    - 10, 11, 12, 13, 14, 15, 16, 17, 18, 19, 20, 21, 22, 23, 24, 27, 30, 32mm
  - 1 - 1/2" Dr. Quick Release Offset Ratchet
  - 1 - 1/2" Dr. Universal Joint
  - 2 - 1/2" Dr. Extension Bars: 125, 250mm
- 3 **T45495** 17pc 1/4", 3/8" & 1/2" Dr. Deep Socket Set (Metric)
  - Contents:
  - 5 - 1/4" Dr. Deep Sockets:
    - 6, 8, 10, 11, 12mm
  - 5 - 3/8" Dr. Deep Sockets:
    - 13, 14, 15, 17, 18mm
  - 7 - 1/2" Dr. Deep Sockets:
    - 19, 21, 22, 24, 27, 30, 32mm
- 4 **A5617** 21pc 1/2" Dr. Impact Socket Set
  - Contents:
  - 9 - 1/2" Dr. Impact Sockets:
    - 13, 15, 16, 17, 18, 19, 21, 22, 24mm
  - 9 - 1/2" Dr. Deep Impact Sockets:
    - 13, 14, 15, 17, 18, 19, 21, 22, 24mm
  - 1 - 1/2" Dr. x 5" Dr. Extension Bar
  - 1 - 1/2" Dr. Universal Joint
  - 1 - 1/2" Dr. (F) x 3/4" (M) Air Impact Adaptor
- 5 **T40596** 10pc Open-End Wrench Set (6 x 7 - 30 x 32mm)
  - Contents:
  - 6 x 7, 8 x 9, 10 x 11, 12 x 13, 14 x 15, 16 x 17, 18 x 19, 20 x 22, 24 x 27, 30 x 32mm
- 6 **T40694** 6pc "75-Degree Offset" Box Wrench Set (8 x 9 - 18 x 19mm)
  - Contents:
  - 8 x 9, 10 x 11, 12 x 13, 14 x 15, 16 x 17, 18 x 19mm
- 7 **T28593** 5pc High Leverage Pliers Set
  - Contents:
  - 1 - 5" (125mm) High Leverage Mini Long Nose Pliers
  - 1 - 5" (125mm) High Leverage Mini Diagonal Cutting Pliers
  - 1 - 7-1/2" (190mm) High Leverage Long Nose Pliers
  - 1 - 7-1/2" (190mm) High Leverage Diagonal Cutting Pliers
  - 1 - 7-1/2" (190mm) High Leverage Combination Pliers
- 8 **T28946** 3pc Pliers and Wrench Set
  - Contents:
  - 1 - 8" (200mm) Adjustable & Pipe Stubby Wrench
  - 1 - 10" (250mm) Lock Grip Pliers

1 - 9-1/2" (240mm) Water Pump Pliers

9 **T28949** 4pc Snap Ring Pliers Set

Contents:

- 1 - 7" (180mm) Straight Nose Pliers
- 1 - 7" (180mm) Bent Nose Internal Pliers
- 1 - 7" (180mm) Straight Nose External Pliers
- 1 - 7" (180mm) Bent Nose External Pliers

10 **T22937** 42pc Hex & Star Wrench Set (Metric & SAE)

Contents:

- 7 - Folding Hex Wrench Set
  - 1.5, 2, 2.5, 3, 4, 5, 6mm
- 8 - Folding Tamper-Proof Star Wrench Set
  - T8, T10, T15, T20, T25, T27, T30, T40
- 9 - "L" Type Star Wrenches:
  - T10, T15, T20, T25, T27, T30, T40, T45, T50
- 9 - "L" Type Long Ball Point Hex Wrenches (SAE):
  - 1/16", 5/64", 3/32", 1/8", 5/32", 3/16", 1/4", 5/16", 3/8"
- 9 - "L" Type Long Hex Wrenches (Metric):
  - 1.5, 2, 2.5, 3, 4, 5, 6, 8, 10mm

11 **T32795** 7pc "Power Grip" Screwdriver Set (PH & Slotted)

Contents: (Chrome Molybdenum Steel)

- 4 - Slotted: 4.0 x 80, 5.5 x 125, 6.5 x 150, 8.0mm x 200mm
- 3 - Phillips: #1 x 80mm, #2 x 100mm, #3 x 150mm

12 **T18408** 9pc 8" Professional File Set

Contents:

- 6 - Needle Files (3mm x 100mm):
  - Round, Half-Round, Flat, Square, Equaling, Triangle
- 3 - 8" (200mm) Pro Style Files:
  - Round, Half-Round, Triangle

13 **T23347** 18pc Multi-Use Tool Set (Saw / Screwdriver / Knives / Tape Measures)

Contents:

- 9 - Quick-Clamp Recip Saw & Bit Driver
  - 1 - Metal Saw
  - 1 - Wood Saw
  - 1 - Bit Driver
- 6 - 1/4" Screwdriver Bits:
  - 2 - Slotted: 3/16", 1/4"
  - 2 - Phillips: #1, #2
  - 2 - Star: T15, T20
- 2 - Auto-Lock Tape Measure (Stainless Steel Case) :
  - 3m x 16mm, 5m x 19mm
- 1 - Auto Lock Snap-Off Knife
- 1 - Utility Knife
- 5 - Utility Knife Replacement Blades

14 **T29642** 11pc Punch & Chisel Set

Contents:

- 5 - Pin Punches: 2 x 140, 3 x 150, 4 x 180, 5 x 200, 6 x 210mm
- 3 - Taper Punches: 4 x 185, 5 x 185, 6 x 185mm
- 1 - Center Punches: 2.5 x 185mm
- 2 - Cold Chisels: 12 x 160, 16 x 170mm

15 **T20684** 4pc Hammer, Chisel & Punch Set

Contents:

- 1 - 10" Flat Cold Chisel
- 1 - 10" Center Punch
- 1 - 2-in-1 Quick-Change Hammer (20oz.)
- 1 - Engineer's Hammer (16oz.)

## T47142

### 316pc 8-Drawer Wagon Professional Tool Set

Contents:

- 1 **T45997** 52pc 1/4" & 3/8" Dr. Fits-All Socket Set
  - Contents:
  - 12 - 1/4" Dr. Fits-All Sockets:
    - 4.5, 5, 5.5, 6, 6.5, 7, 8, 9, 10, 11, 12, 13mm
  - 10 - 3/8" Dr. Fits-All Sockets:



- 10, 11, 12, 13, 14, 15, 16, 17, 18, 19mm
- 2 - Quick Release Offset Ratchets: 1/4" Dr. & 3/8" Dr.
- 2 - Extension Bars: 1/4" Dr x 6", 3/8" Dr. x 3"
- 2 - Universal Joints: 1/4" Dr. & 3/8" Dr.
- 1 - 1/4" Dr. Go-Thru Spinner Handle
- 1 - 1/4" Bit Holder
- 22 - 1/4" Bits:
  - 9 - Slotted: 3, 4 (2pc), 5 (2pc), 5.5, 6, 7mm (2pc)
  - 5 - Phillips: #1, #2 (2pc), #3 (2pc)
  - 2 - Pozi: #2, #3
  - 4 - Star: T10, T15, T20, T25
  - 2 - Hex: 4, 5mm
- 2 **T45847** 22pc 1/2" Dr. Fits-All Socket Set  
Contents:
  - 18 - 1/2" Dr. Fits-All Sockets:
    - 10, 11, 12, 13, 14, 15, 16, 17, 18, 19, 20, 21, 22, 23, 24, 27, 30, 32mm
  - 1 - 1/2" Dr. Quick Release Offset Ratchet
  - 1 - 1/2" Dr. Universal Joint
  - 2 - 1/2" Dr. Extension Bars: 125, 250mm
- 3 **T45495** 17pc 1/4", 3/8" & 1/2" Dr. Deep Socket Set (Metric)  
Contents:
  - 5 - 1/4" Dr. Deep Sockets:
    - 6, 8, 10, 11, 12mm
  - 5 - 3/8" Dr. Deep Sockets:
    - 13, 14, 15, 17, 18mm
  - 7 - 1/2" Dr. Deep Sockets:
    - 19, 21, 22, 24, 27, 30, 32mm
- 4 **T33226** 22pc 1/2" Dr. Star Bit Socket and External Star Socket Set  
Contents:
  - 9 - 1/2" Dr. Star Bit Sockets:
    - T20, T25, T27, T30, T40, T45, T50, T55, T60
  - 4 - 1/2" Dr. Star Bit Sockets (100mm):
    - T40, T45, T50, T55
  - 9 - 1/2" Dr. External Star Sockets:
    - E10, E11, E12, E14, E16, E18, E20, E22, E24
- 5 **A5617** 21pc 1/2" Dr. Impact Socket Set  
Contents:
  - 9 - 1/2" Dr. Impact Sockets:
    - 13, 15, 16, 17, 18, 19, 21, 22, 24mm
  - 9 - 1/2" Dr. Deep Impact Sockets:
    - 13, 14, 15, 17, 18, 19, 21, 22, 24mm
  - 1 - 1/2" Dr. x 5" Dr. Extension Bar
  - 1 - 1/2" Dr. Universal Joint
  - 1 - 1/2" Dr. (F) x 3/4" (M) Air Impact Adaptor
- 6 **T29642** 11pc Punch & Chisel Set  
Contents:
  - 5 - Pin Punches: 2 x 140, 3 x 150, 4 x 180, 5 x 200, 6 x 210mm
  - 3 - Taper Punches: 4 x 185, 5 x 185, 6 x 185mm
  - 1 - Center Punches: 2.5 x 185mm
  - 2 - Cold Chisels: 12 x 160, 16 x 170mm
- 7 **T41486** 14pc Geared Combination Wrench Set (8 - 19mm)  
Contents:
  - 12 - Wrenches:
    - 8, 9, 10, 11, 12, 13, 14, 15, 16, 17, 18, 19mm
  - 2 - Adaptors: 1/4" x 13mm, 3/8" x 19mm
- 8 **T42674** 14pc Fits-All Combination Wrench Set (6 - 24mm)  
Contents:
  - 6, 8, 10, 12, 13, 14, 15, 16, 17, 18, 19, 21, 22, 24mm
- 9 **T42676** 3pc Fits-All Combination Wrench Set  
Contents:
  - 27, 30, 32mm
- 10 **T40597** 11pc Open-End & Ratcheting Box Wrench Set (6 x 7 - 20 x 22mm)  
Contents:
  - 8 - Open-End Wrenches:

- 6 x 7, 8 x 9, 10 x 11, 12 x 13, 14 x 15, 16 x 17, 18 x 19, 20 x 22mm
- 3 - Ratcheting Box Wrenches: 8 x 10, 12 x 14, 13 x 15mm
- 11 **T40694** 6pc "75-Degree Offset" Box Wrench Set (8 x 9 - 18 x 19mm)  
Contents:
  - 8 x 9, 10 x 11, 12 x 13, 14 x 15, 16 x 17, 18 x 19mm
- 12 **T22937** 42pc Hex & Star Wrench Set (Metric & SAE)  
Contents:
  - 7 - Folding Hex Wrench Set
    - 1.5, 2, 2.5, 3, 4, 5, 6mm
  - 8 - Folding Tamper-Proof Star Wrench Set
    - T8, T10, T15, T20, T25, T27, T30, T40
  - 9 - "L" Type Star Wrenches:
    - T10, T15, T20, T25, T27, T30, T40, T45, T50
  - 9 - "L" Type Long Ball Point Hex Wrenches (SAE):
    - 1/16", 5/64", 3/32", 1/8", 5/32", 3/16", 1/4", 5/16", 3/8"
  - 9 - "L" Type Long Hex Wrenches (Metric):
    - 1.5, 2, 2.5, 3, 4, 5, 6, 8, 10mm
- 13 **T32795** 7pc "Power Grip" Screwdriver Set (PH & Slotted)  
Contents: (Chrome Molybdenum Steel)
  - 4 - Slotted: 4.0 x 80, 5.5 x 125, 6.5 x 150, 8.0mm x 200mm
  - 3 - Phillips: #1 x 80mm, #2 x 100mm, #3 x 150mm
- 14 **T32191** 8pc Electrical Screwdriver Set (VDE1000V)  
Contents:
  - 3 - Phillips: #0 x 75, #1 x 100, #2 x 100mm
  - 4 - Slotted: 3.0 x 75, 4.0 x 100, 5.5 x 125, 6.5 x 150mm
  - 1 - Circuit Tester: 120V - 250V
- 15 **T28593** 5pc High Leverage Pliers Set  
Contents:
  - 1 - 5" (125mm) High Leverage Mini Long Nose Pliers
  - 1 - 5" (125mm) High Leverage Mini Diagonal Cutting Pliers
  - 1 - 7-1/2" (190mm) High Leverage Long Nose Pliers
  - 1 - 7-1/2" (190mm) High Leverage Diagonal Cutting Pliers
  - 1 - 7-1/2" (190mm) High Leverage Combination Pliers
- 16 **T28946** 3pc Pliers and Wrench Set  
Contents:
  - 1 - 8" (200mm) Adjustable & Pipe Stubby Wrench
  - 1 - 10" (250mm) Lock Grip Pliers
  - 1 - 9-1/2" (240mm) Water Pump Pliers
- 17 **T46062** 4pc Cutters and Scraper Set  
Contents:
  - 1 - "Straight Cut" Aviation Tin Snips
  - 1 - 8" Multi-Purpose Angled Shear
  - 1 - PVC Pipe Cutter
  - 1 - Stubby Scraper
- 18 **T28949** 4pc Snap Ring Pliers Set  
Contents:
  - 1 - 7" (180mm) Straight Nose Pliers
  - 1 - 7" (180mm) Bent Nose Internal Pliers
  - 1 - 7" (180mm) Straight Nose External Pliers
  - 1 - 7" (180mm) Bent Nose External Pliers
- 19 **T22905** 7pc T-Handle Tamper-Proof Star & Star Wrench Set  
Contents:
  - T10, T15, T20, T25, T27, T30, T40
- 20 **T22906** 7pc T-Handle Ball Point & Hex Wrench Set (Metric)  
Contents:
  - 2.5, 3, 4, 5, 6, 7, 8mm
- 21 **T29587** 5pc Wood Chisel & Rasp File Set  
Contents:
  - 1 - 8" (200mm) Round Wood Rasp File
  - 1 - 8" (200mm) Flat Wood Rasp File
  - 3 - Wood Chisels: 12, 19, 25mm





- 22 **T18408** 9pc 8" Professional File Set  
Contents:  
6 - Needle Files (3mm x 100mm):  
Round, Half-Round, Flat, Square, Equaling, Triangle  
3 - 8" (200mm) Pro Style Files:  
Round, Half-Round, Triangle
- 23 **T23347** 18pc Multi-Use Tool Set (Saw / Screwdriver / Knives /  
Tape Measures)  
Contents:  
9 - Quick-Clamp Recip Saw & Bit Driver  
1 - Metal Saw  
1 - Wood Saw  
1 - Bit Driver  
6 - 1/4" Screwdriver Bits:  
2 - Slotted: 3/16", 1/4"  
2 - Phillips: #1, #2  
2 - Star: T15, T20  
2 - Auto-Lock Tape Measure (Stainless Steel Case) :  
3m x 16mm, 5m x 19mm  
1 - Auto Lock Snap-Off Knife  
1 - Utility Knife  
5 - Utility Knife Replacement Blades
- 24 **T20684** 4pc Hammer, Chisel & Punch Set  
Contents:  
1 - 10" Flat Cold Chisel  
1 - 10" Center Punch  
1 - 2-in-1 Quick-Change Hammer (20oz.)  
1 - Engineer's Hammer (16oz.)

### **T73335**

#### **4pc Snap Ring Pliers Set**

- Contents:  
1 - 7" (180mm) Straight Nose Internal Pliers  
1 - 7" (180mm) Bent Nose Internal Pliers  
1 - 7" (180mm) Straight Nose External Pliers  
1 - 7" (180mm) Bent Nose External Pliers



<b>Model</b>	<b>Page</b>	<b>Model</b>	<b>Page</b>	<b>Model</b>	<b>Page</b>	<b>Model</b>	<b>Page</b>
A1001	422	A2428	394	A3130	395	A3750	401
A1002	422	A2432	395	A3155	397	A3910	409
A1101	423	A2439	394	A3156	397	A3911	409
A1401	424	A2443	394	A3157	397	A3915	410
A1407	424	A2451	395	A3158	397	A3916	410
A1412	426	A2452	395	A3159	397	A3922	410
A1414	425	A2508	422	A3221	425	A3923	411
A1418	426	A2509	422	A3222	425	A3930	411
A1419	426	A2510 - A2512	421	A3326	424	A4065	391
A1424	426	A2513 - A2515	421	A3327	424	A4071	391
A1425	426	A2516 - A2518	421	A3331	424	A4120	368
A1426	423	A2519 - A2521	421	A3332	424	A4122	369
A1428	423	A2522 - A2524	421	A3347	425	A4125	370
A1429	423	A2525 - A2527	421	A3350	425	A4128	368
A1430	423	A2528 - A2530	421	A3531	425	A4129	369
A1431	423	A2531 - A2533	421	A3532	425	A4131	368
A1432	415	A2540 - A2542	418	A3533	424	A4135	370
A1435	423	A2543 - A2545	418	A3534	424	A4140	369
A1436	423	A2546 - A2548	418	A3630	371	A4142	368
A1437	417	A2549 - A2551	418	A3634	373	A4143	370
A1438	414	A2552 - A2555	418	A3638	371	A4144	369
A1440	414	A2559 - A2562	418	A3639	373	A4210	386
A1441	424	A2570	418	A3640	373	A4211	386
A1458	415	A2571	419	A3641	371	A4212	386
A1460	422	A2572	420	A3646	371	A4224	388
A1461 - A1463	415	A2573	422	A3649	372	A4231	390
A1464	422	A2650	414	A3651	372	A4243	389
A1465	417	A2654	414	A3652	372	A4244	386
A1480	415	A2664	414	A3655	372	A4249	389
A1481	416	A3000	383	A3659	374	A4252	390
A1484	416	A3001	383	A3664	374	A4261	388
A1485	416	A3002	384	A3666	374	A4263	387
A1486	417	A3003	384	A3668	375	A4264	387
A1495	416	A3014	380	A3670	375	A4265	387
A1604	408	A3015	380	A3675	375	A4266	388
A1605	408	A3016	381	A3676	376	A4269	388
A1606	408	A3017	380	A3677	376	A4270	389
A1607	408	A3019	380	A3678	377	A4271	389
A1643	408	A3020	381	A3679	378	A4291	390
A1644	364	A3026	381	A3681	377	A4292	390
A1645	364	A3028	381	A3682	377	A4301	398
A1702	426	A3033	382	A3685	378	A4302	398
A1705	422	A3034	382	A3686	378	A4312	398
A1706	424	A3035	382	A3687	376	A4313	399
A2302	402	A3037	382	A3691	379	A4314	398
A2303	400	A3038	383	A3693	379	A4315	399
A2304	402	A3039	384	A3700	413	A4316	399
A2305	401	A3040	385	A3706	403	A4321	399
A2307	400	A3041	385	A3708	403	A4400	392
A2308	400	A3042	385	A3709	403	A4401	392
A2309	402	A3070	384	A3714	413	A4408	392
A2311	400	A3075	385	A3715	412	A4410	392
A2319	401	A3090	385	A3716	412	A4411	392
A2321	401	A3101	396	A3721 - A3723	412	A4427	393
A2322	413	A3104	396	A3724 - A3725	412	A4455	393
A2325	402	A3112	396	A3735	413	A4456	393
A2425	394	A3121	397	A3738	411	A4476	393

Model	Page	Model	Page	Model	Page	Model	Page
A4506 - A4522.....	120	A5615 .....	128	A6516 - A6518.....	419	T12839 - T12843 .....	461
A4558 - A4582.....	121	A5616 .....	39	A6519 - A6521.....	419	T12849 - T12856 .....	461
A4637 - A4690.....	121,122	A5617 .....	20	A6522 - A6525.....	419	T12860 - T12862 .....	462
A4637S.....	124	A5620 .....	128	A6529 - A6532.....	419	T12870 - T12871 .....	463
A4639S.....	124	A5621 .....	128	A6533 - A6536.....	422	T12880 - T12881 .....	462
A4641S.....	124	A5622 .....	128	A6550 - A6552.....	420	T12885 - T12886 .....	461
A4710 - A4719.....	120	A5623 .....	128	A6553 - A6555.....	420	T12890 .....	463
A4750 - A4765.....	121	A5624 .....	128	A6556 - A6558.....	420	T12895 .....	463
A4817 - A4900.....	123, 124	A5625 .....	128	A6559 - A6561.....	420	T12900 .....	463
A4817S.....	125	A5626 .....	128	A6562 - A6565.....	420	T12905 - T12911 .....	461
A4819S.....	125	A5627 .....	128	A6569 - A6572.....	420	T12914 - T12921 .....	462
A4821S.....	125	A5628 .....	128	A6700 - A6750.....	124	T12923 - T12925 .....	461
A4906 - A4922.....	120	A5630 .....	129	T11183 - T11188 .....	254	T12929 - T12931 .....	462
A4958 - A4982.....	121	A5631 .....	129	T11201.....	62	T12940 - T12941 .....	463
A4967T.....	125	A5632 .....	129	T11203.....	62	T12945 - T12953 .....	462
A4967TP.....	125	A5633 .....	129	T11206.....	62	T12960 .....	463
A4969T.....	125	A5634 .....	129	T11300 - T11324.....	83	T13160 .....	298
A4969TP.....	125	A5635 .....	129	T11328.....	85	T13162 .....	298
A4971T.....	125	A5636 .....	129	T11331 - T11338.....	83	T14302 - T14306 .....	309
A4971TP.....	125	A5637 .....	129	T11340.....	85	T14307 - T14308 .....	309
A4972T.....	125	A5638 .....	129	T11341.....	85	T14309 .....	309
A4972TP.....	125	A5639 .....	129	T11342.....	82	T14321 .....	302
A5037 - A5070.....	121,122	A5640 .....	129	T11345 - T11347.....	84	T14323 .....	301
A5037S.....	124	A5641 .....	129	T11348 - T11350.....	84	T14324 .....	301
A5039S.....	124	A5642 .....	129	T11351 - T11352.....	84	T14327 .....	302
A5041S.....	124	A5650 .....	130	T11354 - T11358.....	83	T14328 .....	302
A5120 - A5151.....	121,122	A5651 .....	130	T11363 - T11369.....	85	T14330 - T14335 .....	301
A5120S.....	124	A5720 - A5760.....	123	T11370.....	86	T14336 - T14339 .....	302
A5121S.....	124	A5720S.....	125	T11375.....	86	T14355 .....	302
A5123S.....	124	A5721S.....	125	T11385.....	90	T14361 .....	301
A5217 - A5290.....	123, 124	A5723S.....	125	T11390.....	80	T14400 .....	320
A5217S.....	125	A5800 - A5805.....	125	T11391.....	80	T14401 .....	320
A5219S.....	125	A5810 - A5819.....	125	T11400 - T11426.....	83	T15100 .....	330
A5221S.....	125	A5830 - A5847.....	126	T11441.....	90	T15105 - T15106 .....	330
A5320 - A5363.....	123	A5850 - A5852.....	126	T11443.....	90	T15110 - T15111 .....	330
A5320S.....	125	A5860 - A5869.....	127	T11445.....	90	T15116 - T15117 .....	330
A5321S.....	125	A5871 - A5879.....	126	T12000 - T12002.....	225	T15800 - T15803 .....	242
A5323S.....	125	A5900 - A5913.....	120	T12003 .....	225	T15810 .....	47
A5410 - A5419.....	120	A5920 - A5929.....	120	T12004 .....	225	T15918 .....	268
A5450 - A5465.....	121	A5930 - A5943.....	120	T12006 - T12008.....	225	T15919 .....	269
A5520 - A5542.....	121,122	A5960 - A5969.....	120	T12010 - T12068.....	226	T15924 .....	269
A5520S.....	124	A6022 .....	404	T12090 - T12100.....	216	T15925 .....	268
A5521S.....	124	A6023 .....	405	T12265 - T12276.....	226	T17001 .....	465
A5523S.....	124	A6025 .....	405	T12290 .....	225	T17002 .....	465
A5580 .....	130	A6029 .....	406	T12291 .....	224	T17008 .....	466
A5581 .....	130	A6033 .....	404	T12292 .....	224	T17101 .....	471
A5590 .....	130	A6034 .....	407	T12293 .....	224	T17104 .....	471
A5591 .....	130	A6035 .....	404	T12300 - T12311 .....	225	T17205 .....	207
A5600 .....	127	A6050 .....	406	T12502 - T12512.....	472	T17206 .....	207
A5601 .....	127	A6058 .....	405	T12522 - T12532.....	472	T17400 - T17411 .....	336
A5602 .....	127	A6059 .....	406	T12542 - T12552.....	472	T17420 .....	336
A5603 .....	127	A6072 .....	407	T12562 - T12575.....	472	T17423 .....	336
A5610 .....	127	A6225 .....	409	T12615 - T12686.....	473	T17440 .....	335
A5611 .....	127	A6313 .....	383	T12800 .....	306	T17441 .....	335
A5612 .....	128	A6314 .....	383	T12810 .....	306	T17443 .....	335
A5613 .....	128	A6510 - A6512.....	419	T12812 - T12814 .....	306	T17700 .....	334
A5614 .....	128	A6513 - A6515.....	419	T12815 .....	306	T17701 .....	334



<b>Model</b>	<b>Page</b>	<b>Model</b>	<b>Page</b>	<b>Model</b>	<b>Page</b>	<b>Model</b>	<b>Page</b>
T17705	334	T20103	316	T20802	334	T23023	185
T17715	334	T20104	316	T20803	335	T23025 - T23027	185
T18400	43	T20105	316	T20820	333	T23050 - T23065	189
T18405	308	T20107 - T20108	316	T20824	334	T23070 - T23073	189
T18406	308	T20160 - T20171	340	T20827	333	T23075	189
T18407	43	T20570 - T20571	250	T21100 - T21102	101	T23080 - T23083	189
T18408	22	T20576 - T20577	251	T21105 - T21110	56	T23090	189
T18410	309	T20580 - T20586	254	T21111	101	T23093	189
T18416	308	T20590 - T20596	254	T21130	298	T23202	263
T18417	308	T20600 - T20605	250	T21131	298	T23203	263
T18418	308	T20610 - T20614	250	T21470 - T21472	328	T23204	263
T18419	308	T20621 - T20625	253	T21475 - T21477	328	T23205 - T23206	262
T18420	308	T20627 - T20628	252	T21500	440	T23207	263
T18421 - T18424	309	T20630	253	T22802 - T22812	190	T23208	264
T18430	281	T20631 - T20632	253	T22815 - T22841	190	T23212	263
T18431	281	T20613	250	T22870	223	T23215	262
T18432	281	T20634	253	T22890	182	T23216 - T23218	262
T18433	281	T20637 - T20638	252	T22891	182	T23219 - T23221	262
T18434	281	T20641 - T20643	256	T22896	188	T23224	263
T18435	281	T20648 - T20649	252	T22897	188	T23225	263
T18436	281	T20650	255	T22900	190	T23230	47
T18437	281	T20653	255	T22901	190	T23240	266
T18438	281	T20654	255	T22902	190	T23241	266
T18439	281	T20655 - T20656	250	T22903	41	T23245	265
T18446	309	T20657 - T20658	250	T22904	41	T23246	265
T18447	309	T20660 - T20662	250	T22905	21	T23280	264
T18451	308	T20667	256	T22906	21	T23281	264
T18452	308	T20670	253	T22924 - T22934	186	T23282	264
T18453	308	T20672 - T20677	251	T22935	183	T23283	265
T18454	308	T20680	42	T22937	21	T23284	265
T18455	308	T20681	254	T22938	45	T23285	266
T19702	345	T20684	22	T22939	45	T23286	264
T19726	346	T20688	251	T22940	188	T23287	266
T19727	346	T20690	253	T22941	188	T23288	266
T19728	346	T20691	253	T22942	188	T23289	266
T20010	326	T20693	251	T22946	183	T23290	266
T20011	326	T20694	251	T22947	183	T23292	265
T20012	326	T20696	252	T22948	183	T23293	265
T20013 - T20014	326	T20697	252	T22949	183	T23294	265
T20015	327	T20698	252	T22955	187	T23298	265
T20016	326	T20700 - T20717	87	T22956	187	T23315	264
T20017	327	T20718 - T20719	90	T22960	187	T23335	264
T20018	327	T20721	88	T22962	187	T23341	264
T20020	327	T20722	88	T22967	188	T23346	43
T20021	327	T20724	88	T22970	188	T23347	22
T20026	326	T20727	88	T22972	188	T23360	262
T20027	326	T20729	88	T22981	188	T23890 - T23893	346
T20080	327	T20730	88	T22983	182	T23895 - T23898	345
T20081	327	T20732 - T20736	87	T22984	182	T23909	352
T20084	328	T20741 - T20749	87	T22985	182	T23910	347
T20085	328	T20752	86	T22990 - T22998	187	T23913	352
T20086	328	T20753	86	T23000	182	T23914	347
T20087	328	T20754	86	T23001	182	T23917	351
T20088	327	T20756	86	T23002	182	T23919	352
T20089	327	T20760 - T20763	87	T23010 - T23011	184	T23921	349
T20098	328	T20800	335	T23012 - T23017	184	T23922	353
T20102	316	T20801	335	T23020 - T23021	185	T23923	353





<b>Model</b>	<b>Page</b>	<b>Model</b>	<b>Page</b>	<b>Model</b>	<b>Page</b>	<b>Model</b>	<b>Page</b>
T23929	344	T25550 - T25556	297	T28340 - T28341	247	T28741	238
T23951	342	T25570	299	T28342 - T28344	246	T28745	243
T23956	348	T25571	299	T28350	239	T28746	243
T23959	348	T25580	295	T28351	239	T28747	243
T23965	354	T25582	298	T28352	239	T28748	243
T23966	354	T25587	297	T28353	239	T28749	243
T23967	353	T25600	269	T28354	239	T28750	243
T23968	349	T25601	269	T28355	239	T28760	236
T23971	350	T25602	269	T28356 - T28358	235	T28761	236
T23975 - T23977	342	T25604	269	T28361 - T28362	246	T28762	236
T23980	350	T25606	269	T28365 - T28369	246	T28770	231
T23985	350	T25608	42	T28370 - T28373	235	T28771	231
T23990	351	T25650 - T25658	269	T28375 - T28376	246	T28772	231
T23991	351	T25665	270	T28378 - T28380	246	T28806 - T28808	234
T23992	351	T25666	270	T28387 - T28389	246	T28816 - T28817	234
T23993	351	T25667	270	T28390	47	T28827	234
T23994	351	T25668	270	T28391	46	T28846 - T28848	234
T23995	351	T25760	444	T28392	46	T28850	238
T23996	351	T25761	444	T28394	233	T28851	237
T23997	348	T25802	290	T28395	230	T28852	238
T24000	349	T25900 - T25915	293	T28396	46, 230	T28853	237
T24010	343	T25920 - T25922	293	T28397	46	T28854	237
T24011	343	T25926 - T25931	293	T28450 T28451	244	T28855	237
T24012	344	T25936 - T25944	293	T28452 - T28453	244	T28856	237
T24700 - T24702	272	T25950 - T25955	293	T28454 - T28456	244	T28857	237
T24706	273	T25960 - T25965	294	T28457	244	T28860 - T28861	240
T24707	273	T27910	280	T28470	245	T28863 - T28864	240
T24710	272	T27911	280	T28480	245	T28866	238
T24711	273	T27913	280	T28481	245	T28870 - T28872	246
T25000	338	T27914	280	T28482	245	T28946	21
T25003	338	T27916 - T27919	280	T28506 - T28508	229	T28949	21
T25006 - T25010	339	T27920 - T27921	280	T28511 - T28512	229	T28950	41
T25011 - T25015	338	T27922	280	T28516	229	T28951	41
T25021 - T25045	337	T27928	306	T28527	229	T28952	41
T25060	339	T27990	298	T28538	242	T28953	41
T25061	339	T28230	248	T28546 - T28548	229	T28954	41
T25062	339	T28231	248	T28551	230	T28955	41
T25200 - T25212	332	T28232	248	T28552	230	T28956	238
T25206	333	T28233	248	T28553	230	T28957	236
T25220 - T25221	333	T28234	248	T28571	229	T28958	46, 231
T25320	290	T28255 - T28256	247	T28580	228	T28959	238
T25335	299	T28257 - T28259	247	T28581	228	T28960	240
T25370 - T25377	292	T28260	247	T28582	228	T28961	240
T25380 - T25387	292	T28261 - T28262	247	T28586	228	T28962	246
T25390 - T25393	291	T28263	247	T28587	228	T28963	41
T25400 - T25410	292	T28265 - T28267	247	T28588	228	T28964	44
T25411 - T25419	292	T28268 - T28270	247	T28591	228	T28965	41
T25430	296	T28271	248	T28592	228	T28966	41
T25431	297	T28273	248	T28593	21	T28967	236
T25432	295	T28274	248	T28610 - T28612	135	T29006 - T29008	232
T25433 - T25439	296	T28305 - T28308	234	T28620 - T28621	135	T29015 - T29017	232
T25490 - T25498	291	T28315 - T28317	234	T28622	135	T29021 - T29022	232
T25510 - T25520	291	T28321 - T28322	235	T28627 - T28629	169	T29027	232
T25536	296	T28327	234	T28630 - T28634	267	T29046 - T29048	232
T25538	295	T28330 - T283331	235	T28637 - T28639	267	T29056 - T29057	232
T25540	295	T28332	235	T28675	235	T29060	232
T25545	296	T28336 - T28338	234	T28700 - T28705	242	T29070 - T29071	232



<b>Model</b>	<b>Page</b>	<b>Model</b>	<b>Page</b>	<b>Model</b>	<b>Page</b>	<b>Model</b>	<b>Page</b>
T29090 - T29094	233	T29790 - T29792	76	T31025 - T31027	289	T32190	42, 206
T29180 - T29181	305	T29793 - T29795	76	T31030 - T31031	289	T32191	22
T29185 - T29186	305	T29796	82	T31035	288	T32200 - T32265	198
T29206	295	T29797	82	T31040	288	T32280	209
T29213 - T29215	294	T29800 - T29802	78	T31041	288	T32290	199
T29216 - T29218	294	T29808	76	T31042	288	T32293	199
T29235 - T29237	294	T29809 - T29811	77	T31043	288	T32294	199
T29240	295	T29815 - T29817	76	T31047 - T31049	289	T32295	200
T29245	47	T29818 - T29820	74	T31050	290	T32296	199
T29400 - T29402	329	T29821 - T29823	78	T32000 - T32051	195	T32405 - T32462	204
T29406	329	T29824 - T29826	78	T32060	197	T32501 - T32537	203
T29407	329	T29828	76	T32061	197	T32581	90
T29517 - T29519	283	T29830 - T29832	77	T32090	196	T32650 - T32660	206
T29520 - T29527	283	T29836 - T29838	75	T32091	196	T32670 - T32688	206
T29530 - T29538	283	T29839	77	T32092	197	T32700 - T32770	192
T29560 - T29565	283	T29845 - T29846	75	T32093	42	T32790	193
T29572	300	T29848 - T29849	74	T32095	42	T32791	42, 193
T29575 - T29582	282	T29850 - T29852	74	T32096	196	T32792	194
T29585	282	T29856 - T29858	75	T32097	197	T32793	42, 193
T29586	282	T29859	78	T32098	42	T32794	46
T29587	22	T29860 - T29862	74	T32099	196	T32795	22
T29591 - T29597	282	T29866 - T29868	75	T32100	74	T32796	194
T29600	282	T29869	78	T32101	224	T32799	193
T29611	286	T29871	74	T32103	210	T32800 - T32843	201
T29612	286	T29872	74	T32105	209	T32890 - T32893	202
T29626	286	T29873 - T29874	74	T32106	210	T32894	47, 202
T29631 - T29635	283	T29875 - T29876	74	T32107	210	T33006 - T33016	98
T29640	285	T29877 - T29879	76	T32109	212	T33026 - T33036	98
T29641	285	T29880	79	T32114	211	T33043 - T33059	98
T29642	22	T29881	79	T32116	208	T33063 - T33079	99
T29643	285	T29885	79	T32117	209	T33080 - T33086	99
T29644	284	T29890	79	T32118	211	T33090 - T33099	98
T29649	284	T29895	79	T32119	211	T33106 - T33116	98
T29650	284	T29903 - T29908	79	T32120	211	T33126 - T33136	98
T29653	285	T29913 - T29916	75	T32124	208	T33143 - T33159	98
T29654	42, 284	T29928 - T29931	75	T32126	209	T33163 - T33179	99
T29655	286	T30900 - T30901	300	T32130	212	T33180 - T33186	99
T29656	42	T30902	41	T32132	210	T33201 - T33209	100
T29658	284	T30905	300	T32133	210	T33210	99
T29659	286	T30915 - T30916	267	T32134	210	T33211	99
T29661	285	T30918	267	T32140 - T32143	207	T33212	99
T29666	300	T30919	267	T32151 - T32155	212	T33215	100
T29747 - T29749	77	T30920	268	T32156	212	T33216	223
T29753 - T29755	80	T30921	268	T32157	46	T33220 - T33222	100
T29756 - T29758	78	T30923	268	T32163	203	T33223	100
T29759	80	T30940	267	T32164	46	T33224	39
T29761 - T29762	81	T31001	287	T32166	213	T33225	39
T29763	81	T31002	287	T32168	213	T33226	20
T29766	81	T31005	287	T32170 - T32171	213	T33230	100
T29770	81	T31006	287	T32173	42	T33231	100
T29771	81	T31007	287	T32175	214	T33240	100
T29772	81	T31009	290	T32178	214	T33241	100
T29773	81	T31010	287	T32179	44	T33242	100
T29776	81	T31011	287	T32183	205	T33250	219
T29778	77	T31015	287	T32185	42	T33253	219
T29779	77	T31018 - T31019	287	T32186	205	T33254	222
T29780	78	T31021 - T31023	289	T32188	204	T33256	221



<b>Model</b>	<b>Page</b>	<b>Model</b>	<b>Page</b>	<b>Model</b>	<b>Page</b>	<b>Model</b>	<b>Page</b>
T33258 .....	221	T335651 - T335691 .....	95	T35931 - T35971 .....	312	T40093 - T40096 .....	157
T33259 .....	221	T335702 - T335718 .....	96	T36011 - T36040 .....	312	T40106 - T40165 .....	154
T33260 .....	218	T335764 - T335790 .....	96	T36101 - T36158 .....	312	T40170 .....	155
T33261 .....	127	T33606 - T33621 .....	99	T36181 - T36210 .....	312	T40171 .....	45
T33262 .....	127	T33636 - T33641 .....	99	T36260 - T36263 .....	312	T40173 .....	154
T33263 .....	218	T33645 .....	99	T36280 - T36285 .....	312	T40179 .....	39
T33265 .....	224	T33650 .....	89	T37001 - T37005 .....	305	T40180 .....	154
T33266 .....	219	T33660 - T33667 .....	98	T38700 - T38704 .....	311	T40181 .....	154
T33267 .....	220	T33670 - T33677 .....	98	T38709 - T38713 .....	311	T40182 .....	40
T33268 .....	225	T33700 - T33707 .....	216	T38718 .....	311	T40185 .....	155
T33269 .....	224	T33710 - T33714 .....	217	T38720 .....	311	T40186 .....	155
T33270 .....	223	T33720 .....	221	T38721 .....	311	T40187 .....	40
T33271 .....	222	T33721 .....	221	T38724 .....	311	T40188 .....	40
T33272 .....	222	T33722 .....	219	T38726 .....	311	T40189 .....	43
T33273 .....	47	T33726 .....	223	T39401 - T39408 .....	136	T40190 .....	155
T33274 .....	220	T33906 .....	318	T39421 - T39428 .....	136	T40191 .....	155
T33280 - T33284 .....	97	T33907 .....	318	T39440 - T39442 .....	136	T40192 .....	40
T33290 .....	224	T33908 - T33909 .....	318	T39803 - T39815 .....	133	T40193 .....	43
T33292 .....	224	T33910 .....	318	T39820 .....	46,133	T40195 .....	155
T33293 .....	468	T33915 .....	317	T39821 .....	46,133	T40230 - T40250 .....	156
T33294 .....	468	T33916 .....	318	T39824 - T39835 .....	133	T40260 - T40282 .....	154
T33300 - T33308 .....	89	T33918 .....	317	T39841 .....	134	T40506 - T40592 .....	160
T33312 - T33319 .....	90	T33920 .....	317	T39844 - T39845 .....	134	T40593 .....	40
T33320 - T33327 .....	89	T33921 .....	318	T39850 - T39853 .....	134	T40595 .....	160
T33331 - T33335 .....	90	T34001 - T34053 .....	469	T39856 - T39859 .....	132	T40596 .....	21
T33336 - T33339 .....	89	T34070 - T34072 .....	470	T39861 - T39864 .....	134	T40597 .....	21
T33340 - T33343 .....	89	T34080 .....	470	T39866 - T39869 .....	132	T40606 - T40692 .....	162
T33344 - T33345 .....	89	T34100 - T34133 .....	469	T39870 .....	134	T40693 .....	40
T33348 - T33349 .....	87	T34150 .....	470	T39871 .....	132	T40694 .....	21
T33350 - T33356 .....	97	T34151 .....	470	T39872 .....	134	T40801 - T40895 .....	153
T33358 - T33368 .....	97	T34170 - T34199 .....	469	T39900 .....	180	T40909 - T40940 .....	164
T33370 - T33378 .....	97	T34201 - T34223 .....	469	T39901 .....	174	T40941 .....	40
T33380 - T33384 .....	97	T34240 - T34242 .....	470	T39905 .....	174	T40950 - T40969 .....	164
T33390 - T33397 .....	89	T34250 .....	471	T39910 - T39911 .....	175	T40990 .....	164
T334000 - T334013 .....	92	T34251 .....	471	T39913 - T39926 .....	174	T40991 .....	164
T334100 - T334111 .....	92	T35101 - T35105 .....	258	T39931 - T39933 .....	172	T41006 - T41092 .....	158
T334201 - T334214 .....	92	T35106 - T35116 .....	259	T39938 .....	175	T41206 - T41286 .....	159
T334251 - T334264 .....	93	T35118 .....	260	T39945 - T39955 .....	174	T41308 - T41393 .....	138
T334301 - T334314 .....	92	T35121 .....	260	T39956 - T39959 .....	174	T41406 - T41469 .....	140
T334351 - T334363 .....	93	T35140 - T35150 .....	260	T39960 - T39964 .....	179	T41480 .....	40
T334400 - T334420 .....	93,94	T35155 - T35157 .....	260	T39965 - T39968 .....	175	T41482 - T41484 .....	140
T334450 - T334470 .....	94	T35160 - T35164 .....	260	T39969 - T39971 .....	179	T41486 .....	20
T334500 - T334522 .....	93,94	T35166 .....	260	T39972 - T39974 .....	176	T41487 - T41488 .....	141
T334550 - T334570 .....	94	T35200 - T35216 .....	474	T39976 .....	178	T41489 .....	40
T334652 - T334681 .....	95	T35220 - T35228 .....	475	T39977 .....	178	T41490 - T41493 .....	140
T334860 - T334887 .....	96	T35230 .....	474	T39980 - T39983 .....	178	T41494 .....	141
T335001 - T335014 .....	92	T35231 .....	474	T39984 .....	178	T41496 .....	40
T335101 - T335114 .....	92	T35235 - T35239 .....	475	T39985 - T39989 .....	173	T41608 - T41665 .....	143
T335206 - T335222 .....	92	T35250 .....	476	T39990 - T39999 .....	176	T41680 - T41685 .....	143
T335256 - T335272 .....	93	T35252 .....	476	T40006 - T40068 .....	156	T41686 - T41689 .....	144
T335306 - T335322 .....	92	T35258 .....	476	T40070 - T40080 .....	157	T41690 - T41693 .....	143
T335356 - T335372 .....	93	T35900 .....	314	T40081 .....	156	T41694 .....	144
T335408 - T335436 .....	93,94	T35901 .....	47	T40082 .....	156	T41700 .....	87
T335458 - T335482 .....	94	T35902 - T35905 .....	313	T40083 .....	157	T41708 - T41714 .....	86
T335508 - T335532 .....	93,94	T35906 - T35907 .....	314	T40084 .....	157	T41720 - T41726 .....	168
T335558 - T335582 .....	94	T35920 .....	314	T40090 .....	45	T41729 .....	169
T335601 - T335641 .....	95	T35926 .....	314	T40091 .....	156	T41730 - T41737 .....	168



<u>Model</u>	<u>Page</u>	<u>Model</u>	<u>Page</u>	<u>Model</u>	<u>Page</u>	<u>Model</u>	<u>Page</u>
T41738 - T41739	168	T43206 - T43227	151	T45425	39	T45901	59
T41740	169	T43240	152	T45429	20	T45902	59
T41741 - T41744	170	T43300 - T43317	177	T45432	102	T45907	60
T41880	165	T43400 - T43408	176	T45433 - T45443	101	T45909	61
T41881	165	T45000	104	T45462	111	T45911	61
T41940	161	T45001	103	T45470	110	T45912	60
T41945	161	T45003	103	T45480	111	T45916	61
T41950 - T41965	161	T45005	103	T45486	111	T45917	60
T41970 - T41980	161	T45010	104	T45487	112	T45970	66
T41990 - T41992	161	T45011	104	T45488	112	T45971	66
T41993	46	T45012	105	T45490	113	T45972	66
T42008 - T42060	157	T45013	39	T45495	20	T45973	68
T42092 - T42096	157	T45014	104	T45500	104	T45974	67
T42308 - T42332	145	T45030	39	T45502	103	T45980	65
T42351 - T41365	145	T45032	39	T45503	103	T45981	65
T42380 - T42383	145	T45033	45	T45506 - T45509	101	T45990	71
T42387 - T42388	146	T45040	102	T45510	105	T45991	72
T42390 - T42392	145	T45070	108	T45512	105	T45992	72
T42395	146	T45085	45	T45530 - T45532	110	T45993	72
T42400 - T42423	165	T45100	104	T45535	43	T45994	71
T42450	163	T45101	103	T45586	102	T45995	72
T42460	163	T45102	103	T45587	102	T45996	43
T42461	163	T45106	218	T45601 - T45610	108	T45997	20
T42500 - T42520	148	T45107	218	T45620	110	T45999	72
T42550	147	T45110	104	T45622	109	T46055	44
T42555	147	T45111	104	T45652	110	T46056	44
T42570	167	T45120	20	T45658	111	T46058	43
T42571	167	T45200	104	T45660	112	T46059	41
T42572	166	T45201 - T45206	103	T45672	114	T46060	47
T42573	167	T45207	39	T45680	115	T46061	47
T42577	166	T45208	39	T45681	114	T46062	21
T42580	167	T45210	105	T45684	114	T46070	113
T42582	166	T45211	105	T45690	115	T46072	113
T42583	166	T45212	105	T45700	107	T47002	48
T42586	166	T45230	109	T45701	107	T47003	48
T42590	166	T45231	109	T45705	116	T47004	48
T42591	166	T45233 - T45237	103	T45710	118	T47005	48
T42594	166	T45235	102	T45715	118	T47010 - T47014	44
T42606 - T42632	149	T45239	45	T45720 - T45741	107	T47015 - T47017	56
T42670 - T42673	150	T45240	39	T45750 - T45752	117	T47018 - T47020	55
T42674	21	T45260	109	T45753	118	T47021 - T47025	56
T42675	150	T45270	109	T45754	118	T47026 - T47029	55
T42676	21	T45285	45	T45755	117	T47031	18
T42677	40	T45300	104	T45760 - T45762	107	T47032	18
T42678	40	T45301 - T45306	103	T45780 - T45785	107	T47033	18
T42706 - T42719	139	T45320	106	T45809	66	T47034	18
T42751 - T42753	139	T45330	109	T45821	67	T47035	18
T42808 - T42838	142	T45331	109	T45822	39	T47036	18
T42850 - T42861	142	T45400	104	T45823	66	T47037	18
T42960 - T42973	146	T45401	101	T45825	67	T47038	19
T42980	147	T45402	103	T45831	68	T47049	48
T42990	147	T45403 - T45406	101	T45836	68	T47052	48
T43000 - T43026	177	T45407	103	T45840	71	T47057	49
T43080 - T43083	177	T45408	47	T45843	71	T47059	49
T43104 - T43114	152	T45409	101	T45846	71	T47062	50
T43120	152	T45410 - T45412	105	T45847	20	T47063	50
T43121	152	T45414 - T45417	106	T45900	58	T47064	49



Model	Page	Model	Page	Model	Page	Model	Page
T47066	49	T51040	467	T70041	488	T70176	485
T47072	52	T51397	468	T70042	488	T70177	485
T47073	51	T51410 - T51415	465	T70043	488	T70178	485
T47074	55	T51425	467	T70044	489	T70179	485
T47075	53	T58000	356	T70045	482	T70185	498
T47077	52	T58001	356	T70046	482	T70186	498
T47078	50	T58002	356	T70047	484	T70187	498
T47079	51	T58003	356	T70048	482	T70200	499
T47083	54	T58004	356	T70049	484	T70201	499
T47084	51	T58005	356	T70052	515	T70301	322
T47085	53	T58006	356	T70056	560	T70303	322
T47086	54	T58007	356	T70061	490	T70306	322
T47088	53	T58200	357	T70062	497	T70308	322
T47089	52	T58201	357	T70063	490	T70310 - T70321	322
T47100	25	T58300	359	T70065	490	T70322 - T70324	322
T47101	25	T58350	358	T70068	490	T70326	323
T47103	26	T58351	358	T70069	490	T70327	323
T47104	27	T58352	358	T70070	549	T70328	323
T47105	26	T58353	358	T70074	490	T70331	323
T47108	14	T58400	359	T70075	499	T70332	323
T47111	27	T58401	359	T70076	499	T70333	323
T47116	34	T58430	358	T70079	497	T70401	324
T47117	35	T58431	358	T70080	496	T70402	324
T47119	32	T58500	362	T70082	496	T70403	324
T47120	31	T58530	362	T70083	491	T70404	324
T47121	36	T58531	362	T70084	491	T70405	324
T47122	28	T58601	360	T70085 - T70092	498	T70406	324
T47123	30	T58602	360	T70095	485	T70407	324
T47125	29	T58603	360	T70096	482	T70409	324
T47126	33	T58604	360	T70098	483	T70410	324
T47130	24	T58800	360	T70100	483	T70411	324
T47131	24	T58820	361	T70101	483	T70412	324
T47140	10	T58821	361	T70102	483	T70413	324
T47141	11	T58822	361	T70103	483	T70414	324
T47142	12, 13	T58823	361	T70115	491	T70415	324
T47200	15	T58824	361	T70126	514	T70416	325
T47201	15	T58830	361	T70137	491	T70417	324
T47204	15	T58840	361	T70139	491	T70418	324
T47206	16	T58850	361	T70140	492	T70420	325
T47207	16	T58860	360	T70141	492	T70423	323
T47220	17	T70002	481	T70142	491	T70424	324
T47221	17	T70004	481	T70143	491	T70425	324
T49833 - T49835	76	T70005	481	T70145	491	T70426	323
T49932 - T49936	19	T70014	481	T70147	499	T70427	323
T50040 - T50098	464	T70015	481	T70149	499	T70430	324
T50100 - T50150	464	T70022	487	T70150	499	T70501	500
T50155 - T50180	464	T70024	487	T70155	492	T70503	500
T50232	466	T70026	487	T70156	492	T70505	500
T50235	466	T70029	487	T70157	492	T70507	500
T50250 - T50274	464	T70030	487	T70165	496	T70537	500
T50340	466	T70031	487	T70166	496	T70538	500
T50341	467	T70032	488	T70170	493	T70539	500
T50350 - T50581	464	T70033	487	T70171	493	T70540	500
T50850 - T50852	465	T70034	488	T70172	493	T70545	493
T50860	466	T70036	488	T70173	493	T70547	503
T50861	467	T70039	488	T70174	485	T70556	499
T51000 - T51034	465	T70040	488	T70175	485	T70557	543



Model	Page	Model	Page	Model	Page	Model	Page
T70564	503	T70756	319	T71244	480	T71709	537
T70565	503	T70760	320	T71245	527	T71731 - T71733	537
T70569	513	T70766	320	T71246	530	T71785	538
T70570	513	T70767	320	T71247	531	T71791	538
T70573	513	T70768	320	T71248	531	T71792	538
T70577	503	T70769	320	T71249	531	T71797	538
T70578	503	T70772	319	T71252	527	T71798	538
T70579	492	T70773	319	T71253	528	T71803	538
T70584	503	T70774	320	T71255	531	T71804	538
T70590	516	T70785 - T70788	560	T71259	528	T71893	539
T70600	516	T70789 - T70792	560	T71265	528	T71895	539
T70602	516	T70918	522	T71266	528	T71899	539
T70604	516	T70931	522	T71268	529	T71900	539
T70606	516	T70932	523	T71292	529	T71917	539
T70608	516	T70933	523	T71293	529	T71921	539
T70609	518	T70962	523	T71294	529	T72001 - T72006	544
T70615	516	T71001	523	T71295	530	T72009 - T72011	544
T70616	557	T71015	242	T71301	531	T72040	545
T70620	518	T71031	524	T71317	528	T72041	545
T70621	518	T71032	524	T71320	533	T72044	544
T70630	503	T71046	524	T71321	533	T72047	544
T70640	517	T71055	526	T71322	533	T72048	544
T70643	516	T71063	526	T71324	533	T72049 - T72051	545
T70646	517	T71066	524	T71328	534	T72054	545
T70647	517	T71068	524	T71334	534	T72055	546
T70648	517	T71069	532	T71336	534	T72058	549
T70650	517	T71075	526	T71340	534	T72059	549
T70652	517	T71091	524	T71405	530	T72060	549
T70654	517	T71092	524	T71436	535	T72061	549
T70655	517	T71093	524	T71460	535	T72062	549
T70660	518	T71094	525	T71465	535	T72064	550
T70663	518	T71100	478	T71466	535	T72066	549
T70665	519	T71101	478	T71467	535	T72067	550
T70675	519	T71102	478	T71519	543	T72068	550
T70676	519	T71103	478	T71522	543	T72069	550
T70677	519	T71104	479	T71525	543	T72070	550
T70678	519	T71120	490	T71538	484	T72072	504
T70681	520	T71131	525	T71565	207	T72074	550
T70682	520	T71140	525	T71566	207	T72090	550
T70701	518	T71146	479	T71578	536, 542	T72092	550
T70702	213	T71151	525	T71581	536	T72093	551
T70703	214	T71164	525	T71584	536	T72094	551
T70706	518	T71176	525	T71600 - T71603	536	T72098	551
T70708	520	T71180	525	T71605	536	T72101	543
T70711	522	T71181	525	T71607	536	T72104	551
T70712	522	T71182	526	T71609	536	T72117	303
T70714	278, 520	T71185	526	T71610	537	T72118	303
T70715	522	T71186	526	T71611	537	T72119	303
T70736	278, 522	T71187	526	T71614	537	T72120	303
T70737	278, 522	T71190	514	T71622	537	T72121	304
T70741	319	T71192	479	T71633	537	T72123	304
T70742	319	T71205	527	T71634	537	T72124	551
T70743	319	T71206	527	T71640	540	T72135	557
T70745	319	T71209	527	T71652	538	T72138	543
T70748	319	T71222	527	T71658	539	T72139	543
T70750	319	T71240	527	T71664	538	T72140	489
T70755	319	T71242	527	T71682 - T71684	542	T72158	555



Model	Page	Model	Page	Model	Page	Model	Page
T72159	555	T73505	275	T74195	505	T75632	558
T72160	556	T73552	274	T74196	505	T75637	492
T72164	556	T73580	277	T74197	505	T75638	492
T72165	556	T73583	276	T74199	505	T75639	493
T72167	556	T73584	274	T74531	255	T75700	486
T72169	556	T73585	276	T74533	255	T75701	528
T72175	556	T73601	303	T74536	255	T75702	530
T72207	556	T73605	303	T74537	255	T75703	528
T72231	556	T73616	275	T74610	560	T75704	529
T73000	186	T73617	276	T74611	310	T75705	526
T73001	186	T73619	275	T74613	310	T75709	531
T73003	186	T73620	275	T74615	310	T75710	532
T73004	186	T73621	275	T74616	310	T75713	480
T73006	187	T73655	276	T74617	310	T75714	480
T73007	187	T73685	276	T74619	310	T75715	535
T73010	186	T73762	520	T74620	310	T75717	480
T73012	186	T73763	520	T74622	310	T75740	559
T73014	187	T73766	520	T74701	174	T75742	559
T73016	187	T73777	263	T74705	180	T75746	547
T73040	186	T73778	263	T75301 - T75334	546	T75756	542
T73041	186	T73785	278,523	T75350 - T75356	547	T75759	320
T73147	557	T73791	278,523	T75501	507	T75761	513
T73148	557	T73824	332	T75502	489	T75762	513
T73151	557	T73825	333	T75506	513	T75770	547
T73153	557	T73876	505	T75508	497	T75771	482
T73158	560	T73904	520	T75511	507	T75773	547
T73302	558	T73915	504	T75512	497	T75774	548
T73303	558	T73916	504	T75513	521	T75775	530
T73310	241	T73920	506	T75514	508	T75776	530
T73321 - T73323	268	T73921	506	T75517	552	T75777	551
T73330	241	T73922	506	T75518	481	T75779	484
T73331 - T73334	241	T73925	304	T75520	515	T75780	483
T73335	46	T74100	512	T75521	491	T75781	483
T73336	241	T74102	505	T75523	498	T75783	546
T73337	241	T74104	505	T75524	498	T75785	495
T73338	241	T74105	505	T75526	497	T75787	481
T73339	241	T74106	505	T75531	487	T75791	485
T73351 - T73354	241	T74107	505	T75532	506	T75793	548
T73360	542	T74113	506	T75533	521	T75795	547
T73361	542	T74114	506	T75538	489	T75799	549
T73383 - T73390	541	T74115	506	T75541	501	T75800	504
T73402	560	T74117	506	T75542	501	T75801	553
T73404	561	T74132	505	T75543	502	T75802	552
T73405	561	T74134	505	T75545	502	T75803	496
T73406	561	T74135	505	T75550	541	T75804	552
T73410	561	T74136	505	T75551	515	T75805	540
T73420	514	T74137	505	T75602	555	T75806	553
T73430 - T73432	493	T74162	505	T75603	499	T75808	540
T73433	494	T74163	505	T75604	511	T75809	554
T73434	494	T74164	505	T75607	494	T75810	554
T73472 - T73476	561	T74165	505	T75609	512	T75811	554
T73479 - T73484	561	T74166	505	T75611	494	T75812	553
T73483	294	T74167	505	T75617	494	T75813	508
T73489	275	T74169	505	T75621	495	T75815	508
T73491	277	T74192	505	T75623	495	T75816	541
T73500 - T73503	274	T74193	505	T75624	495	T75819	554
T73504	274	T74194	505	T75630	558	T75820	543



<u>Model</u>	<u>Page</u>	<u>Model</u>	<u>Page</u>	<u>Model</u>	<u>Page</u>	<u>Model</u>	<u>Page</u>
T75822	543	T80322	454	T80952	447		
T75823	552	T80325	455	T81210	364		
T75830	489	T80334	452	T81211	364		
T75831	541	T80335	453	T81217	364		
T75832	546	T80336	454	T81220	365		
T75836	496	T80338	455	T81221	365		
T75837	496	T80360	456	T81222	365		
T75838	496	T80361	456	T81223	366		
T75840	559	T80365	457	T81230	366		
T75842	560	T80366	457	T81231	366		
T75860	498	T80385	431	T81240	367		
T75867	539	T80386	448	T81241	367		
T75868	545	T80506	428	T81242	367		
T75869	555	T80510	431	T81250	364		
T75871	324	T80540	430	T81251	364		
T75872	325	T80545	431	T81257	364		
T75875	325	T80548	429	T81260	365		
T75877	542	T80549	429	T81261	365		
T75879	540	T80550	428	T81262	365		
T75881	512	T80551	430	T81263	366		
T75900	532	T80552	429	T81270	366		
T75901	542	T80555	430	T81271	366		
T75902	521	T80700	439	T81280	367		
T75903	555	T80800	433	T81281	367		
T75904	504	T80801	433	T81282	367		
T75905	521	T80806	433	T81290	458		
T75906	510	T80808	432	T81291	458		
T75907	511	T80813	434	T81300	459		
T75908 - T75910	511	T80814	434	T81302	458		
T75911	529	T80815	434	T81303	458		
T75912	510	T80820	441	T81307	459		
T75914	509	T80825	438	T81310	460		
T75916	505	T80826	438	T81311	459		
T75917 - T75919	506	T80827	438	T81312	460		
T75920	510	T80832	435	T81313	460		
T75921	511	T80835	435				
T75926	509	T80838	435				
T75927	557	T80841	437				
T75928	557	T80842	437				
T75932	304	T80847	441				
T75937	504	T80850	440				
T75939	509	T80853	440				
T75941	510	T80856	439				
T75948	509	T80858	441				
T75949	512	T80900	446				
T75990	514	T80903	446				
T75992	514	T80904	447				
T80252	428	T80911	436				
T80275	432	T80916	443				
T80300	449	T80921	437				
T80301	450	T80922	442				
T80302	451	T80930	444				
T80310	449	T80931	444				
T80311	450	T80936	442				
T80312	451	T80937	448				
T80320	452	T80938	436				
T80321	453	T80943	443				



<b>A</b>			
A/C Clutch Wrenches	515	Air Sand Blasters	413
A/C Fuel Line Coupling Tools	482, 485	Air Sanders	386 - 390
A/C Fuel Line Disconnect Tools	483	Air Sanding Pad Adaptors	424
ABS Brake Pressure Test Kits	541	Air Sanding Pads	422
Adjustable Air Blow Guns	415, 416	Air Saw & File	401
Adjustable Breaker Bars	88	Air Scalars	398, 399
Adjustable Hook Wrenches	169	Air Spot Drills	395
Adjustable Nozzles	360	Air Spray Guns	406
Adjustable Pipe Cutting Pliers	543	Air Staplers	409
Adjustable Pipe Wrenches	134	Air Stripping Tools	413
Adjustable Rakes	357	Air Swivel Connectors	422
Adjustable Socket & Bit Driver	90	Air Tire Buffers	413
Adjustable Trigger Hose Nozzles	361	Air Tire Chucks	423
Adjustable Box Joint Pliers	240	Air Tire Inflator with Gauge	423
Adjustable Groove Joint Pliers	240	Air Tool Accessory Kits	422
Adjustable Wrenches	46, 133, 134	Air Undercoating Guns	412
Air Bag Release Tools	520, 521	Air Utility Cut-Off Tool	400
Air Belt Sanders	390	Air Wet Sanders	390
Air Blow Guns	415, 416, 417	Air Whip Hoses	425
Air Body Saw	400	Aluminum Pipe Wrenches	136
Air Brake Service Tools	540	Aluminum Shower Head Water Wand	361
Air Brush Kits	408	Angled Flat Band Hose Clamp Pliers	558
Air Caulking Guns	412	Angled Shears	268
Air Chipping Hammers	397	Antenna & Radio Service Set	529
Air Chisels	398, 399, 426	Anti-Freeze Testers	500
Air Clutch Screwdrivers	392, 393	Anvil Pruners	358
Air Compressor - Belt Driven	365, 366	Anvils	311
Air Compressor - Oil	366	Arbors	470
Air Compressor - Direct Driven	364	Arched Mini Pliers	237 - 238
Air Compressor - Vertical	367	Arched Pliers	237 - 238
Air Compressors - Mini	364	Auto Body Filler Applicators	516
Air Control Units	414	Auto Cigarette Socket Adaptors	526
Air Dent Pullers	411	Auto Computer Memory Units	530
Air Die Grinders	380 - 384	Auto Feed Screwdrivers	442
Air Drills	394, 395	Auto Lock Snap-Off Knives	262
Air Engraving Pens	413	Auto Spring Removers	516
Air Files	402	Automatic Battery Charger and Starter	480
Air Fittings - Aro Type	420	Automatic Center Punches	557
Air Fittings - German Type	419	Automatic Coupler Set	514
Air Fittings - Milton Type	418	Automotive Multimeters	479
Air Fittings - Nitto Type	421	Aviation Snips	268
Air Grease Gun Flexible Hoses	425	Awls	522
Air Grease Guns	412	Axes	254
Air Grinders	380 - 385	Axle Nut Sockets	544 - 548
Air Hammers	395 - 397	Axle Spindle Re-Threading Set	494
Air Hose Repair Connectors	422		
Air Hoses	424 - 425	<b>B</b>	
Air Impact Wrenches	371 - 379	Back Saws	289
Air Knives	401	Ball Joint / Tie Rod End Remover	550
Air Metal Shears	401	Ball Joint Adaptor Sets	553 - 554
Air Mini Oiler	423	Ball Joint Extractors	550
Air Nailers	409 - 411	Ball Joint Pullers	551
Air Needle Scalars	399	Ball Joint Separators	549
Air Nibblers	400	Ball Joint Service Sets	553
Air Polishers	391	Ball Pein Hammers	250 - 253
Air Punch & Flange Tools	402	Ball Point Hex Wrench Sets	185
Air Ratchets	368 - 370	Bar Clamps	301, 302
Air Recoil Hoses	425	Battery / Alternator Voltage Testers	525
Air Regulators	423	Battery Analyzers	478
Air Riveters	403	Battery Carriers	524
		Battery Chargers	480

Battery Load Testers	478 - 479	Chalk Lines	298
Battery Post and Terminal Brushes	526	Character Stamps	561
Battery Terminal & Bearing Pullers	524	Chisel Knives	265
Battery Testers	524 - 525	Circuit Sounder	525
Bearing Packers	539	Circuit Testers	525 - 526
Bearing Pullers	506, 510, 512	Clamp Vise	311
Bearing Race / Seal Driver Set	555	Claw Hammers	250 - 253
Bearing Separator Assembly Kit	511	Cleaning Brushes	461 - 463, 522 - 523
Beechwood Mallet	256	Clip Removal Pliers	518
Bench Vise	311	Clip Remover	557
Bevel Wire Wheel Brushes	461	Club Hammers	250 - 252
Bit & Magnetic Tray set	47	Clutch Adjusting Tools	496 - 499
Bit Adaptors	225	Clutch Coupling Tools	484
Bit Couplers	224	Coil Spring Compressors	513
Bit Drivers	197	Cold Chisels	283, 286
Bit Holders	225	Combination Gear Pullers	506
Bit Set with Key Chain	224	Combination Pliers	228 - 230, 232, 234, 244
Bit Sets	468	Combination Square	295
Bits and Bit Sets	98 - 100, 216 - 226	Compact Offset Oxygen Sensor Wrench	481
Blind Bearing Puller Set	509	Compound Miter Saws	290
Bolt Cutters	267	Compression Testers	500
Box Joint Pliers	240	Concrete Vibrators	448
Box Joint Water Pump Pliers	232, 235	Continuity Tester	526
Brake Adjustment Tools	536, 542	Crank Shaft and Harmonic Balancer Holder	510
Brake Bleeders	536 - 539	Crankshaft Drive Belt Pulley Puller Set	512
Brake Cylinder Hone & Stones	538	Crankshaft Locking Tools	492
Brake Cylinder Retainer Remover	539	Crimped Bevel Wire Wheel Brushes	461
Brake Spoons	536	Crimped Cup Wire Brushes	461
Brake Spring Compressors	536 - 537	Crimped Wire End Brushes	462
Brake Spring Tools	536, 537	Crimped Wire Wheel Brushes	461
Brake Spring Washer Tool	539	Crimping Tools	47
Brass Fitting Sets	360	Cross Pein Hammers	250
Brass Pin Punch Set	286	Crowfoot Wrench Sets	167
Brass Punch and Hammer Set	560	Cultivators	356
Breaker Bars	88	Cup Brushes	463
Brick Bolster w/ Hand Guard	286	Cup Wire Brushes	461 - 463
Brick Hammers	251 - 252	Current Leakage Catcher	479
Brush Set	306	Cut-off Wheels	422
Brushes	306, 461 - 463	Cutters -	267 - 269
<b>C</b>		- Bolt Cutters	267
Cable Cutters	267 - 268	- Cable Cutters	267
Cable Knives	266	- PVC Pipe Cutters	268, 269
Calipers	310	Cutting Pliers	229, 232, 234, 244, 543
Cam Locks - Gas & Diesel Engines	496	Cutting Wheel - Wet	472
Camshaft Alignment Tools	491 - 492	Cutting Wheel - Dry	472
Camshaft Drive Belt Pulley Puller	504	Cutting Wheel - Laser Diamond	472
Camshaft Pulley Holding Tool	491	Cutting Wheels	472
Canti-Lever Metal Cases	48	CV Joint Boot Clamp Pliers	517
Canti-Lever Tool Sets	24, 53	Cylinder Hones	538
Car Door Lock-Out Tools	518, 519	<b>D</b>	
Carbide Coated Hole Saw Kits	471	Dandelion Trowels	356
Carburetor Adjusting Tool	531	Dashboard Service Tools	532
Carpenter's Hammers	253	Dead Blow Hammers	255
Carpenter's Pincers	235	Dent Puller Sets	521
Carpenter's Ratchet Brace	306	Dial Type Gauges	556
Caulking Guns	303	Diamond Core Drilling Machine	447
C-Clamps	309	Dies	312
Center Punches	283	Digital Battery Load Test / Charging System Analyzer	478
Centrifugal Pumps	456 - 457	Digital Inverter Generators	449 - 451
Chain Saw Sharpener Kits	476	Digital Multi-Tester	525

Digital Outside Micrometer	310	Electric Polishers	441
Digital Torque Wrenches	172, 173	Electric Portable Vacuum-Blower	431
Disc Brake Calipers	537, 542	Electric Reciprocating Saw	435
Disc Brake Pad Spreader	539	Electric Rotary Hammers	432
Disc Brake Piston Remover	539	Electric Routers	441
Disc Brake Service Tool Sets	542	Electric Scissors	267
Disel Injection Pump Wrench	493	Electric Vacuum Dust Extractors	448
Disel Injector Puller	512	Electrical Precision Tool Sets	41, 42, 46
Door / Window Clip Remover	516	Electrical Screwdriver Sets	560
Door / Window Handle Tool	516	Electrical Tool Kits	47
Door Pin Remover	516	Electronic Pliers	242, 243
Door Upholstery Remover	516	End Nippers	232, 235, 237
Double Flaring Tool Set	542	Engine Compression Testers	500 - 502
Double Flaring Tool and Tube Cutter Set	320, 542	Engine Cylinder Hone & Stones	499
Double J Plate-Grip Pliers	248	Engine Lift Chain	496
Double-Ended Scutch Hammer	251	Engineer Files	22, 43
Drain and Trap Cleaner	320	Engineer's Hammer	250
Drain Plug Key Sets	489	Exhaust Manifold Spreader	499
Drawer Organizer Tray Sets	44	Exhaust Spring Clamp Remover/Installer	543
Drill Press Vise	311	Extendable Ratchet Screwdriver	211
Drive Shaft Boot Changer	551	Extended Spark Plug Socket	528
Drum Pumps - Lever Action	329	Extension Bars	83, 85, 86
Dual Scale Beam Torque Wrenches	174	External & Internal Restorer Files	494
Dual Transfer Pumps	327	External Adjustable Snap Ring Pliers	241
<b>E</b>			
Ear Bands	335	External Deep Star Sockets	97
Ear Plugs	335	External Snap Ring Pliers	241
Earmuffs	336	External Star Sockets	97
Electric Angle Grinder	434	External Thread Restorer Files	493 - 494
Electric Auto-Reverse Tapping & Core Drill Machine	446	Extra Long Flat Box End Wrench Set	163
Electric Belt Sanders	438	<b>F</b>	
Electric Bevelers	443	Faceshield	334
Electric Biscuit Jointer	441	Fan Clutch Wrenches	497
Electric Caulking Guns	440	Fan Hub Wrenches	491
Electric Circular Saws	435	Feeler Gauges	533, 534
Electric Compound & Slide Compound Mitre Saw	437	Fence Pliers	235
Electric Cordless Angle Grinders	430	Files	308 - 309
Electric Cordless Circular Saws	429	Fin Straightener and Cleaner	514
Electric Cordless Delta Sanders	430	Fingernail Brush w/ Magnet	306
Electric Cordless Drills	428	Fits-All Go-Thru Socket Sets	39, 65 - 68
Electric Cordless Grease Guns	432	Fits-All Socket Set	20, 43, 71, 72
Electric Cordless Impact Wrenches	428	Flange Type Axle & Wheel Hub Pullers	504
Electric Cordless Jig Saws	429	Flare Nut Crowfoot Wrench Sets	166, 167
Electric Cordless Mini Grinders	431	Flare Nut Wrench Sets	46, 161, 541
Electric Cordless Orbital Buffers	431	Flaring Tool Set	541, 542
Electric Cordless Planers	430	Flashlights	342 - 354
Electric Cordless Reciprocating Saws	429	Flat Chisels	283
Electric Drywall Sanders	443	Flat Clamp Pliers	558
Electric Finishing Sanders	438	Flat Drill Press Vises	311
Electric Hammers	433	Flex Box End Wrench Sets	166
Electric Hot Air Guns	440	Flex Flare Nut Crowfoot Wrench Sets	166
Electric Impact Drills	433	Flex Handles	87 - 88
Electric Jig Saws	435	Flex Offset Box End Wrench Set	166
Electric Magnetic Drilling Machine	446, 447	Flex Ratcheting Screwdrivers	209
Electric Metal Cutting Circular Saw	436	Flex Ratcheting Socket Wrenches	79
Electric Mini Power Tool Set	439	Flex Retriever Claws	275
Electric Miter Saws	437	Flex Ratcheting Socket Wrenches	79
Electric Mouse Sander	438	Flex Socket Set	102
Electric Paint Mixer	444	Flexible Bit Driver	225
Electric Planers	439	Flexible Flashlight with Magnetic Pickup	276
		Flexible Hose Clamps	503
		Flexible Inspection Mirror w/ Light	274

Flexible Magnetic Pickup Tools	276	- Engineer's Hammers	250
Flexible Torque Wrenches	175	- French Joiner Hammers	251
Flex-Shaft Extendable Magnetic Ratchet Driver set	210	- Mason's Hammers	251
Flip Impact Sockets	549	- Roofing Hammers	251, 252
Flooring Cleat	411	- Rubber Mallet	255
Foldable Extension T-Handles	86	- Safety Exit Hammers	253
Folding Knives	264 - 265	- Scutch Hammers	251
Folding Rapid Pull Saws	288	- Sledge Hammer	254
Folding Retractable saws	288	- Soft Face Hammers	255, 256
Folding Wrench Sets	185, 187, 188	- Stone Hammers	250
Ford Ignition Module Wrench	528	- Stubby Hammers	253
Ford Radio Removal Tool	528	Hand Drills	306
Ford Van Ball Joint Adaptor Set	554	Hand Riveter	300
French Joiner Hammer	251	Hand Saws	289
Front Hub Remover / Installer Set	504	Harmonic Balancer Pullers	505, 509
Front Wheel Drive Axle Puller Adaptor	504	Heater Hose Disconnect Tools	485, 515
Fuel / Filter Disconnect Tool Set	483 - 486	Hedge Shears	358
Fuel Tanks - Portable	330	Helmets	334, 335
FWD Wheel Bearing Adaptor Set	509	Hex & Star Wrench Set	182 - 188
<b>G</b>		High Energy Ignition Spark Tester	527
Garden Groove Cutters	356	High Leverage Pliers	21, 46, 228 - 231
Garden Hose	362	High Speed Drill Bits	464 - 466
Gardening Tool Sets	359	Hobby Knife Set	262
Gasket & Hollow Punch Sets	560	Hobby woodwork's Vise	311
Gasket Scrapers	519	Hole Saws	469 - 471
Gasoline Generators	452 - 454	Hollow Punch Kits	300
Gasoline Welding Generators	455	Hook Blade Sets	263
Gear Pullers	505, 506	Hose Pinchers	503
Gearless Air Angle Die Grinders	381, 382	Hose Pinch-Off Pliers	503
Gearless Extendable Stubby		Hot Air Gun Kit s	440
Precision Screwdriver - 6-in-1	211 - 212	HVLP Air Spray Gun	404 - 407
Gearless Magnetic Ratchet Driver	210, 211	Hydraulic Gear Pullers	511
Generators	452 - 455	Hydraulic Lifter Pullers	487
Gloves	340	Hydraulic Nut Splitters	304
Glue Gun Sticks	316	Hydraulic Valve Tappet Remover	487
Glue Guns	316	<b>I</b>	
Goggles	332, 333	Ignition Coils Pullers	530 - 532
Grass Shears	358	Ignition Experts	480
Grease Accessories Kit	489	Ignition Gauges	534
Grease Fittings	327	Ignition Module Wrench	528
Grease Gun Coupler	328	Ignition Point Files	528
Grease Guns	326	Impact Sockets	120 - 129
Grease Hose	327	Impact Driver Sets	207
Grease Injector Needle	328	Impact Extension Bars	126
Grinding Stones	423, 474 - 476	Impact Flex Sockets	130
Groove Joint Pliers	232, 235, 240	Impact Socket Adaptors	125
<b>H</b>		Impact Universal Joints.	125
Hack Saws & Blades	287	Industrial Star Driver Sets	188
Hammer and Dolly Set	254	Infrared Thermometers	299
Hammer Tacker	260	Injection Pump Wrench	493
Hammer, Chisel & Punch Set	22, 42	Inner Tie Rod Tools	550, 552
Hammers	250 - 256	Insulated Cable Knives	266
- Ball Pein	250, 252, 253	Insulated Drivers	206
- Beechwood Mallet	256	Insulated Pliers	244, 245
- Brick Hammers	251, 252	Insulated Wire Strippers	247
- Carpenter's Hammers	253	Interchangeable Torque Wrenches	176, 178
- Claw Hammers	250, 252, 253	Internal & External Pliers Sets	241
- Club Hammers	250, 252	Inverter Generators	449 - 451
- Cross Pein	250		
- Dead Blow Hammers	255		



<b>J</b>			
Jaw Pliers	248	Masks	338, 339
Jitterbug Sander Pad	424	Masonry Drill Bits	464 - 467
J-Type Plate-Grip Pliers	248	Mason's Hammers	251, 252
Jumbo Hex & Star Wrenches	189	Measuring Wheels	299
<b>K</b>		Metal Cases	48
Keyless Drill Chucks	426	Metal Impulse Sprinklers	360
Knife & Tape Set	47	Metal Pulsating Sprinklers	360
Knives	263	Metal Safety Tanks	330
- Folding Knife	264, 265	Metal Spinning Fan Sprinklers	360
- Insulated Cable Knife	266	Micro Air Die Grinder	383
- Liner-Lock Folding Knife	264, 265	Micro Flashlights	350
- Lockback Folding Knife	264, 265	Micro Ratcheting Bit Driver	224
<b>L</b>		Micro Quick-Release Ratchets	77
L-Handles	90	Micrometers	310
Lantern Flashlight	349	Mini Air Oiler	423
Laser Level Square	298	Mini Brushes	306
Leather Punch	300	Mini Torque Wrenches	174
LED Clip-On Light	350	Miter Saws	290, 437
LED Flashlight w/ Magnetic Pickup	345 - 347	Mitre Square w/ Level	294
LED Flashlights	342 - 354	Multi-Function Flashlights	345 - 349
LED Head Lamp	350	Multi-Function Inspection Tool Sets	277
LED Pen Style Flashlight (1pc AAA)	348, 351	Multi-Function Tools	266
LED Rechargeable Flashlight	342 - 344	Multi-Use Tool Set	22, 43, 44
LED USB Rechargeable Flashlight	342	<b>N</b>	
Level Dependent Earmuffs	336	Nail Punch Set	285
Levels	295 - 297	Nails	260
- 3 Vial Post Spirit Levels	295	Needle Files	309
- Angle Levels w/laser	295	Needle Nose Adaptor	328
- Combination Levels	295	Noid Light & IAC Signal Tester Set	530
- Extendable Spirit Levels	295	Noid Lights	530
- Laser Level Square	298	Non-Magnetic Brass Gauge	535
- LCD Display Digital Levels	296	Non-Woven Bevel Brush	463
- Line Levels	296	Nozzles	360 - 361
- Multi-Function Levels	297	Number Stamps	561
- Self Leveling Laser Levels	297	Nut Drivers	207
- Torpedo Levels	296	Nut Splitters	303 - 304
Lever Action Drum Pumps	329	Nylon Cup Brushes	463
Lever Action Grease Gun	326	Nylon Wheel Brushes	463
Lever Type Blow Gun w / Tip	415	<b>O</b>	
Leverage Hedge Shears	358	O Ring & Hook Scribes	278, 521
Lighted Extensions	80, 82	Offset Boot Clamp Pliers	517
Lock C-Clamp Pliers	246 - 247	Offset Distributor Clamp Wrench	531
Lock Ring Pliers	520	Offset Oxygen Sensor Wrenches	481
Long Reach Pliers Set	239	Offset Pick Tool	522
Lug Nut Cap Removers	551	Offset Pliers	236
Lug Wrenches	168 - 170	Offset Ratchets with Disc	76
<b>M</b>		Offset Ratchet with Disc & Lighted Extension Set	82
Magnetic Finder with Wheels	273	Offset Star Driver Set	213
Magnetic Pickup Tools	275	Offset Tire Gauges	556
Magnetic Rake	273	Oil & Water Separator	423
Magnetic Side Hanging Trays	55	Oil Cooler Line Tool	483, 484
Magnetic Socket Holders	56	Oil Drain Can	330
Magnetic Tissue Holders	56	Oil Filter Wrenches	322 - 325
Magnetic Trays	561	Oil Pressure Switch Sockets	481
Magnetic Welding Holder	298	Oil Pressure Tester Set	502
Mallet - Beechwood	256	Oil Service Tools	43, 44
Mallets	255, 256	Oiler Pistol Flex	327
Manual Brake Gauge Sets	540	Oiler Pistol Rigid	327
		Oiless Diaphragm Compressor w/ Gauge	408
		Open Ended Insert Tools	177

Open Reel Steel Tape Measures	293	PTFE Seal Tapes	424
Optical Fluid Tester	526	Pulley Pullers	490
Outer Tie Rod Remover	552	Pulley Removing Wrench	490
Overhead Valve Spring Compressor	488	Pumps	327, 329, 456, 457, 560
Oxygen Sensor Switch Socket	481 - 482	Punch & Chisel Set	22, 42, 284 - 286, 559
Oxygen Sensor Thread Tool	530	Putty Knives	560
<b>P</b>		PVC Cutters	268 - 269
Paint Mixer	444	<b>Q</b>	
Parts Cleaning Brush	523	Quick Change Hammers	255
Pen Style Flashlight	350	Quick Change Retainer Spring	426
Pen-Type Mini Screwdrive Set (Metric)	212	Quick Change Retractable Knife	263
Pick and Driver Set	278, 522	Quick Change Screwdrivers	209
Pickle Fork Kit	555	Quick Release Magnetic Bit Coupler	224
Pin Punches	283 - 285	Quick Slide Utility Knives	263
Pipe Clamp/Spreader	302	Quick-Clamp Recip Saw & Bit Drivers	290
Pipe Cleaner	320	<b>R</b>	
Pipe Tubing Cutter	268	R134a Air Conditioning Manifold Gauges	514
Pipe Wrenches	136	Radio Removal Tools	529
Piston Ring Compressors	498, 499	Rakes	357
Piston Ring Expanding Tools	498	Rapid Pull Saws	288
Piston Ring Installers	499	Rasp Blades	280
Pitman Arm Pullers	550	Rasp Files	281
Pliers	228 - 248	Rasp Planes	280
- Arched Handle Mini Pliers	237 - 238	Ratchet & Bit Sets	219, 223
- Arched Handle Pliers	237 - 238	Ratchet Drivers	209
- Box Joint Pliers	240	Ratchet Insert Tools	177
- Groove Joint Pliers	240	Ratchet Tie Downs	305
- High Leverage Mini Pliers	228	Ratcheting Flare Nut Wrenches	135
- High Leverage Pliers	228 - 231	Ratcheting Lock Nut Tools	545
- Insulated Pliers	244 - 245	Ratcheting Screwdrivers	208
- Locking Pliers	246 - 248	Ratcheting Tube Cutters	320
- Long Reach Pliers	239	Ratchets	74 - 81
- Mini Pliers	228, 237, 243	- Dual-Drive Extendable	81
- Offset Pliers	236	- Dual-Drive Stubby Extendable	81
- Pipe Cutters	543	- Dual-Drive Micro	77
- Snap Ring Pliers	241	- Dual-Drive Safety Lock	74, 75
- Wire Crimpers & Strippers	242	- Dual-Drive Standard	74
Plumb Bob	298	- Dual-Drive Stubby	74
Pocket Magnetic Pickup Tools	275	- Extendable Flex	81
Pointed Chisel w/ Hand Guard	286	- Extra Long Flex Head	78
Power Bit Sets - Double-End	224, 468	- Heavy Duty	75
Power Clamps	301	- Industrial Reversible	79
Power Clean Up Magnet	272	- Lighted	80
Power Magnetic Pickup Tool	272	- Lightweight	76
Power Nut Bit w/ Magnet	225	- Metal Grip	78
Power Pullers	305	- Quick-Release	74
Power Scissors	560	- Quick-Release Extendable	79
Power Steering Pump Pulley	490, 491, 507	- Regular	78
Precision Gearless Extendable		- Slim Head Quick-Release	75
Ratchet Screwdriver set	211	- Spinner	76
Precision Air Micro Die Grinder	384	Razor Blades	520
Precision Screwdrivers	46, 212, 213	Rear Axle Bearing Pullers	508
Preset Torque Open-End Wrenches	176	Rear Axle Bush Install/Remove Tool s	496
Preset Torque Screwdriver	178	Rear Disc Brake Calipers	540
Preset Torque Wrenches	176	Rechargeable Flashlights	342 - 344
Pressure Washers	458 - 460	Rechargeable Jump Start Systems	535
Pressure Screw Separator Pullers	511	Reel Closed	328
Pruners	358	Reel Open	328
Pry Bar & Wrecking Bars	44, 214	Remote Starter Switches	527
Pry Bars	213 - 214	Replaceable Tip Circlip Pliers Sets	558

Replacement Blades Sets	320	Sledge Hammers	254
Replacement Bulbs	525	Slide Hammer Set	510
Re-Threading Tools	495, 529	Sliding Bevel with Vial	295
Retractable Knives	263	Sliding T-Handle	87
Retractable Safety Scraper	519	Sliding Top Tool Trolley	52
Retractable Tapeline Bit Reel Set	223	Slip Joint Pliers	232, 235
Retractable Utility Knives	263	Snap Ring Pliers	41, 44, 241, 558
Retriever Claw & Lighted Magnetic Pickup Tools	277	Snap-Off & Utility Knives	262, 263
Ribe Bit Set	223	Socket Adaptors	90
Ridge Reamer	498	Socket Combination Wrenches - Swivel	164
Ring Groove Cleaners	498	Socket Holders	101
Ring Insert Tools	177	Socket Wrench - 3-in-1 T-Handle (6PT)	87
Riveters	41	Socket Wrench Sets - Angled	165
Rocker Arm Oil Plugs	490	Socket Wrenches - Flexible	40
Roofing Hammers	251 - 253	Socket Wrenches - Swivel	164
Rotary Tool Accessory & Assortment	476	Socket Wrenches - T-Handle (6PT)	86
Rubber Mallets	255	Sockets & Socket Sets	92 - 96, 101 - 118, 127
Rubber Ring Hook Tools	522	Soft Face Hammer - Tubular Steel Handle	255, 256
Ruler Angle Level w/ Laser	295	Solder Wires	318
<b>S</b>			
S Type Drainer Wrenches	551	Soldering Guns	318
Safety Exit Hammers	253	Soldering Tools	317, 318
Safety Goggles	332, 333	Spade Forks	356
Safety Helmets	334, 335	Spade Rakes	356
Safety Kit	339	Spark Plug Boot Pliers	527
Safety Respirators	337	Spark Plug Gap Gauge	535
Saw Blades	426	Spark Plug Hole Thread Chasers	529
Saw Blades - T.C.T	473	Spark Plug Pliers	528
Saws	288, 289	Spark Plug Remover / Installer	527
- Back Saws	289	Spark Plug Socket with Magnet - T-Handle	87
- Folding Rapid Pull Saws	288	Spark Plug Sockets with Magnet	89
- Hand Saws	289	Spark Plug Wire Pliers & Pullers	527
- Rapid Pull Saws	288	Spark Plug Wire Tester	528
- Wallboard Saws	288	Speeder Handles	90
Scouring Machine	442	Spindle Nut Wrenches	546
Scrapers	269, 270, 519	Spindle Puller	546
- Extendable Scrapers	270	Spinner Handle	90
- Go-Thru Scrapers - Angles	269	Spoke Shave	280
- Go-Thru Scrapers - Straight	269	Spray Hoses	362
- Multi-Purpose Scrapers	269	Spring Lock Coupling Tool Set	482
- Stainless Steel Flex Scrapers	269	Sprinklers	360
- Stubby Scrapers	270	Stainless Steel Dial Vernier Caliper	310
Screw Extractors	557	Stainless Steel Digital Calipers	310
Screwdriver Set - Go-Thru	204, 205	Stainless Steel Rulers	294
Screwdriver Set - Electrical	206	Stainless Steel Straight Rulers	294
Screwdrivers	193 - 214	Stainless Steel Vernier Calipers	310
SDS Chisel Points	465	Stamps	561
SDS Drill Bits	464	Staple Gun Tacker	258, 259
SDS Hammer Drill Bit Sets	466, 467	Staple Remover	260
Seal Driver Sets	555	Staples	260
Seal Off Dispensers	328	- Cable Staples	260
Seal Pullers	543	- Fine Staples	260
Self Leveling Laser Levels	297	- Pin Staples	260
Serpentine Belt Tools	487	Star and E Socket, Bit and Wrench Set	222
Sheet Metal Grip	241	Star Screwdriver Sets	199
Short Nozzle Siphone Spray Set	417	Steel Wire Cup Brush	523
Side Terminal Battery Wrenches	524	Steering Pivot Pin Remover	543
Silicon Carbide Bevel Wire Brushes	463	Steering Wheel Lock Plate Tool	520
Single-Ended Scutch Hammer - Wood Handle	251	Steering Wheel Puller	520
Siphon Pumps	560	Steering Wheel Puller / Lock Plate Compressor Set	521
		Stem Mounted End Brush	523
		Stem Mounted Knotted End Brush	522

Step Drills	465, 467	Tire Inflator w/ Gauge	423
Stethoscope	490	Tire Repair Tools	556
Stone Hammers	250	Tool Cabinets	53 - 55
Straight Jaw Plate-Grip Pliers	248	Tool Chest sets	14, 25 - 27
Straight Line Sander Pad	424	Tool Chests	15, 48 - 50, 52
Straight Pattern Snips	267	Tool Set w/ Aluminum Case	61
Strut Coil Spring Compressor	513	Tool Set w/ Aluminum Trolley Case	58, 59
Stubby Bit Driver	74	Tool Trolley	52
Stubby Claw Hammer - Grip Handle	253	Tool Wagons	15, 16, 50, 51
Stubby Ratchet	77	Torpedo Level	296
Stubby Ratchet & Bit Driver - 2-in-1	370	Torque Angle Gauge	180
Stubby Screwdriver - 8-in-1	210	Torque Calibration Machine	180
Stud Pullers	557	Torque Control Bit Sets	468
Stud Remover and Installer	304	Torque Extension Bar Set	559
Suction Cups	278, 523	Torque Multipliers	179
Suction Lifter Sets	278, 523	Torque Screwdrivers	178
Swivel Bench Vise	311	Torque Wrenches	171 - 176
Swivel Grass Shears	358	Tote Bags	62
<b>T</b>			
Tackers	260	Transmission / Transaxle Plug Set	506
Tailpipe and Tubing Cutters	543	Transplanters	356
Tailpipe Expanders	543	Tri-Fold Measuring Wheel	299
Tap & Die Set	47, 313, 314	Trigger Hose Nozzles	361
Tap Wrenches	312	Trim Tools	518
Tape Measure - Auto Return Closed reel Fiberglass	293	Trolley Tote Bags	62
Tape Measure - Closed Reel	293	Trowels	356
Tape Measures	291 - 294	Tube Benders	319
Tape Measures	291 - 294	Tube Cutters	319, 320
- 4 x Speed Open Reel	294	Tubular Spanner Wrenches	545
- Auto-Lock	291, 292	Tune-Up Gauge	534
- Closed Reel	293	Twisted Bevel Wire Wheel Brushes	462
- Open Reel	293	Twisted Cup Wire Brushes	462
Tape Measures - 4 Speed Open Reel Steel	294	Twisted Wire Wheel Brushes	462
Tape Measures - Lighted Auto-Lock	292	Twister Sockets	547
Tape Measures - Open Reel Fiberglass	293	<b>U</b>	
Taper Punches	283	Ultrasonic Distance Detectors	290
Tappet & Ignition Gauge	534	Universal Adjustable Wrenches	135
Tappet Gauge	534	Universal Camshaft Bearing Tools	495
Taps	312	Universal Flex / Extension Handle	88
Telescopic & Pick Sets	47	Universal Hub Pullers	509
Telescopic Bypass Loppers	359	Universal Joints	89
Telescopic Mirror w/ Pocket Handle	274	Universal Lift Support Clamps	516
Telescopic Tools	274	Universal Pullers	512
Telescoping Magnetic Tools	276	Universal Radiator Pressure Testers	515
Telescoping Rectangular Mirror	274	Universal Terminal Release Tools	532
Tensioning Gauge for Cambelts	496	Universal Valve Spring Compressor	489
Terminal Clamp Spreader	530	Utility Knife Replacement Blades	263
Terminal Release Tools	524, 532	Utility Knives	263, 264
Testing Screwdriver	526	- Folding	264
Threader Chaser	494	- Quick Change Retractable	263
Tie Rod Adjusting Tool	549	- Quick Slide	263
Tie Rod End / Pitman Arm Puller	550	- Retractable	263
Tie Rod End Lifter	549	- Safety	263
Tie Rod Separators	549	Utility Wire Brush	523
Tie Rod Tools	551	UV Light Air Conditioning Leakage Tester	514
Tiger Claw Quick Wrenches	135	<b>V</b>	
Timing Belt Wrench	504	Vacuum & Fuel Pump Testers	500
Timing Gear Puller	504	Vacuum Pump / Brake Bleeding Set	541
Timing Locking Tool Set	492	Valve Adjusting Tools	493
Timing Tool Set	492	Valve Core Torque Tools	556
		Valve Lappers	487



Valve Spring Compressors	487 - 489	- Flare Nut Crowfoot Wrenches	166
Valve Stem Repair Tools	556	- Flare Nut Wrenches	161
Valve Stem Seal Remover	493	- Flex-head Geared Ratcheting	145
Vise	311	- Geared Ratcheting	20, 40, 140, 141
<b>W</b>		- Half-Moon Box	163
Wagon Accessories	18, 19	- Long Style Combination	45, 156 - 157
Wagon Tool sets	10 - 12, 28 - 36	- Offset Box	153
Wall Chasers	436	- Reversible Geared Ratcheting	143 - 144
Wall Scrapers	560	- S-Shape Box End Ratcheting	147
Wallboard Saw	288	- Stubby Combination	157
Water Pumps	456 - 457	- Stubby Geared Ratcheting	138
Water Pump Pliers	229, 240	- Stubby Reversible Geared Ratcheting	142
Water Pump Pulley Holding Wrench	491	- Swivel Socket Wrenches	164
Water Pump Pulley Remover / Installer Set	508	- Thin Wall Combination	39, 40, 43, 154, 155
Water Pump Sockets	546	- Thin Wall Open End	160
Weeders	356	Wrinkle Band Ring Compressors	498
Welder's Wrench	241		
Welding Eye Mask	333		
Welding Goggle	333		
Welding Handshield	333		
Welding Helmet	333, 334		
Wheel Bearing Lock Nut Sockets	544 - 547		
Wheel Brush	463, 522		
Wheel Cover Tool	556		
Wheel Stud Alignment Guide Tools	555		
Wheel Weight Tools	556		
Wide Curved Jaw Pliers	248		
Wide-Jaw Adjustable Wrenches	132, 134		
Window Molding Remover	516		
Windscreen Wiper Arm removal tool	518		
Windshield Molding Door Handle Tool	517		
Windshield Removal Tool	518		
Wire Bevel Brush - Silicon Carbide	463		
Wire Brushes	306, 462		
Wire Crimper	246		
Wire Stripper & Cutter	246		
Wire Stripper Pliers	242		
Wire Wheel Brushes	461, 462, 463		
Wobble Extensions	84		
Wood Chisels	282		
Wood Flat Drills	465, 467		
Wood Planes	280		
Wood Rasp Files	281		
Worker's Safety Sets	332		
Work-Shop Shear Cutter	268		
Workstations	17, 53		
Wrenches	137 - 170		
- 45 Degree Fits-All Box	151		
- 45 Degree Offset Combination	159		
- 4-in-1 Reversible geared Ratcheting	148		
- 75 Degree Offset Combination	21, 40, 162		
- Angled Socket Wrenches	165		
- Construction Wrenches	165		
- Crowfoot Wrenches	167		
- Double Flex-head Geared Ratcheting	146		
- External Star	152		
- Extra Long Box	163		
- Extra Long Combination	158		
- Fits-All	149 - 150		
- Fits-All Geared Ratcheting	21, 40, 139		

# Warranties

AmPro warrants all its products and parts, aside for the exceptions described below, exclusively to the original retail purchaser to be free of defects in materials and workmanship for the life of the products and parts. The life of the products or parts is defined as that point in time when the product or part no longer functions due to normal wear-and tear.

To qualify for AmPro warranty consideration, return the AmPro product or part, along with the original purchase receipt, postage prepaid, to the AmPro authorized service center. If AmPro finds the product or parts to be defective, AmPro, will at its own option, repair or replace the product or part. AmPro reserves the right to determine the integrity of the defectiveness of the product or part using its sole judgment and to repair or replace at AmPro's option

## Hand Tools and Specialty Tools

All AmPro Hand Tools and Specialty Tools are furnished with a lifetime warranty. Each of these products or parts that are found to be defective or do not meet the performance of their specification may be returned, postage prepaid, to the AmPro authorized service center, along with the original purchase receipt for warranty consideration.

## Air Compressors and Power Tools

All AmPro Air Compressors, Power Air Tools and Electrical Tools are furnished with one-year warranty following the purchase date. Failure to have provided proper and regular servicing and maintenance voids the warranty. Proper servicing and maintenance must be performed regularly and is solely the owner's responsibility. Otherwise, each of these products or parts that are found to be defective within one year of original purchase receipt for warranty consideration.

## Torque Wrenches

All AmPro Torque Wrenches come with a 90-day warranty following the purchase date. Failure to have provided proper calibration and regular servicing voids the warranty. Proper calibration and servicing must be performed regular and is solely the owner's responsibility. Otherwise, each of these products or parts that are found to be defective within 90 days of the purchase date may be returned, postage prepaid, to the AmPro authorized service center, along with the original purchase receipt for warranty consideration.

Bits, blades, punches, dies, punches, fuses, belts, grind wheels, sanding pads and other wear-and-tear products are not covered by these warranties. All AmPro warranties do not apply to any product or part that was used for a purchase for which it is not intended, or damaged due to failure to follow its operation or maintenance instructions. Damaged products or parts caused by abuse, misuse, alteration, accident or normal wear are also excluded from all AmPro warranties.

These warranties are exclusive. AmPro makes no other warranty of any kind, expressed or implied, associated with its products. AmPro makes no implied warranty of merchantability, nor implied warranty of fitness and does not authorize any other person to bind AmPro to any other warranty of any kind associated with AmPro products or parts.

AmPro shall not, in any event, be liable for any incidental or consequential damages of any kind resulting from the usage, design, neglect or misuse of any product or for any other reason.

## Important Notice:

Photographs, illustrations and descriptions in this catalog are for reference only. AmPro reserves the right to make changes in tool specifications in this catalog without notice, and without entailing any obligation on our part to modify tools sold previously. When ordering, please inquire if any changes or modifications have been made following publication.

## Copyright AmPro Tools Corp.

All rights are reserved in all countries. No part of this publication may be reproduced without our prior written consent. This material is furnished for the exclusive use of AmPro customers. Any other use is strictly prohibited.